

# WEBENCH® Design Report

Design : 29 LM5160QPWPRQ1  
 LM5160QPWPRQ1 44V-54V to 12.00V @ 1.2A

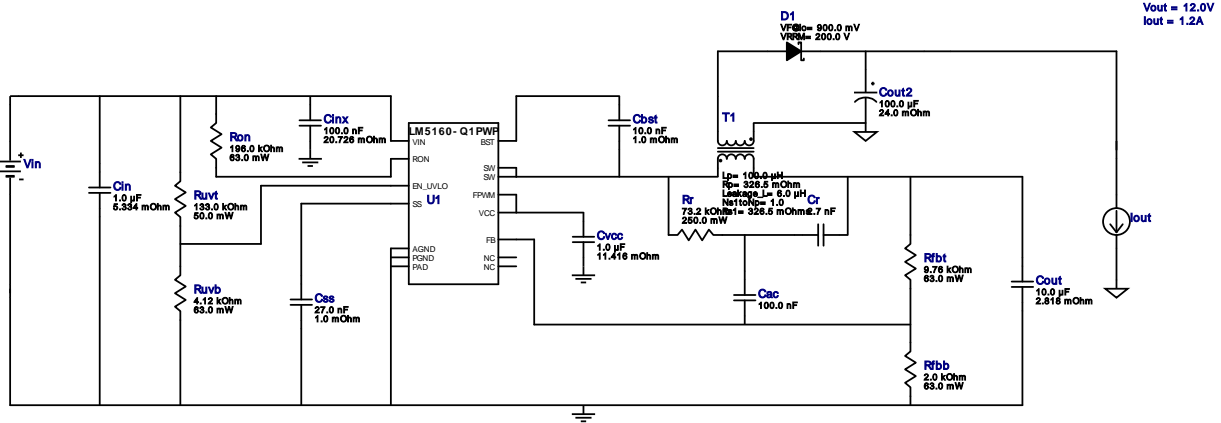

1. Feedback Resistors may need to be further adjusted to get more precise regulation as ripple injection circuit will introduce some amount of DC offset. Use simulation to help adjust.
2. This regulator device is qualified for Automotive applications. All passives and other components selected in this design may not be qualified for Automotive applications. The user is required to verify that all components in the design meet the qualification and safety requirements for their specific application. View WEBENCH(R) Disclaimer.













## Design Alerts

### Component Selection Information

The LM5160-Q1 is qualified for Automotive applications. All passives and other components selected in this design may not be qualified for Automotive applications. The user is required to verify that all components in the design meet the qualification and safety requirements for their specific application.

## Electrical BOM

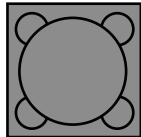
Name	Manufacturer	Part Number	Properties	Qty	Price	Footprint
Cac	AVX	08053C104JAZ2A Series= X7R	Cap= 100.0 nF VDC= 25.0 V IRMS= 0.0 A	1	\$0.07	0805 7 mm <sup>2</sup>
Cbst	MuRata	GRM155R71C103KA01D Series= X7R	Cap= 10.0 nF ESR= 1.0 mOhm VDC= 16.0 V IRMS= 0.0 A	1	\$0.01	0402 3 mm <sup>2</sup>
Cin	MuRata	GRM31CR72A105KA01L Series= X7R	Cap= 1.0 uF ESR= 5.334 mOhm VDC= 100.0 V IRMS= 1.55432 A	1	\$0.24	1206_190 11 mm <sup>2</sup>
Cinx	TDK	CGA4J2X7R2A104K125AA Series= X7R	Cap= 100.0 nF ESR= 20.726 mOhm VDC= 100.0 V IRMS= 1.456 A	1	\$0.04	0805 7 mm <sup>2</sup>
Cout	TDK	C2012X5R1V106K085AC Series= X5R	Cap= 10.0 uF ESR= 2.818 mOhm VDC= 35.0 V IRMS= 3.8868 A	1	\$0.18	0805 7 mm <sup>2</sup>
Cout2	Panasonic	25VSPF100M Series= SVPF	Cap= 100.0 uF ESR= 24.0 mOhm VDC= 25.0 V IRMS= 3.2 A	1	\$0.47	CAPSMT_62_E7 106 mm <sup>2</sup>

Name	Manufacturer	Part Number	Properties	Qty	Price	Footprint
Cr	AVX	1206A272JAT2A Series= C0G/NP0	Cap= 2.7 nF VDC= 50.0 V IRMS= 0.0 A	1	\$0.11	 1206 11 mm <sup>2</sup>
Css	MuRata	GRM155R71C273KA01D Series= X7R	Cap= 27.0 nF ESR= 1.0 mOhm VDC= 16.0 V IRMS= 0.0 A	1	\$0.01	 0402 3 mm <sup>2</sup>
Cvcc	TDK	C1005X6S1C105K050BC Series= X6S	Cap= 1.0 uF ESR= 11.416 mOhm VDC= 16.0 V IRMS= 1.483 A	1	\$0.02	 0402 3 mm <sup>2</sup>
D1	SMC Diode Solutions	SK220ATR	VF@Io= 900.0 mV VRRM= 200.0 V	1	\$0.04	 SMA 37 mm <sup>2</sup>
Rfbb	Vishay-Dale	CRCW04022K00FKED Series= CRCW..e3	Res= 2.0 kOhm Power= 63.0 mW Tolerance= 1.0%	1	\$0.01	 0402 3 mm <sup>2</sup>
Rfbt	Vishay-Dale	CRCW04029K76FKED Series= CRCW..e3	Res= 9.76 kOhm Power= 63.0 mW Tolerance= 1.0%	1	\$0.01	 0402 3 mm <sup>2</sup>
Ron	Vishay-Dale	CRCW0402196KFKED Series= CRCW..e3	Res= 196.0 kOhm Power= 63.0 mW Tolerance= 1.0%	1	\$0.01	 0402 3 mm <sup>2</sup>
Rr	Vishay-Dale	CRCW120673K2FKEA Series= CRCW..e3	Res= 73.2 kOhm Power= 250.0 mW Tolerance= 1.0%	1	\$0.01	 1206 11 mm <sup>2</sup>
Ruvb	Vishay-Dale	CRCW04024K12FKED Series= CRCW..e3	Res= 4.12 kOhm Power= 63.0 mW Tolerance= 1.0%	1	\$0.01	 0402 3 mm <sup>2</sup>
Ruvt	Yageo	RC0201FR-07133KL Series= ?	Res= 133.0 kOhm Power= 50.0 mW Tolerance= 1.0%	1	\$0.01	 0201 2 mm <sup>2</sup>
T1	Coiltronics	DRQ127-101-R	Lp= 100.0 uH Rp= 326.5 mOhm Leakage_L= 6.0 uH Ns1toNp= 1.0 Rs1= 326.5 mOhms	1	\$1.19	 DRQ127 210 mm <sup>2</sup>
U1	Texas Instruments	LM5160QPWPRQ1	Switcher	1	\$2.12	 PWP0014A_N 59 mm <sup>2</sup>

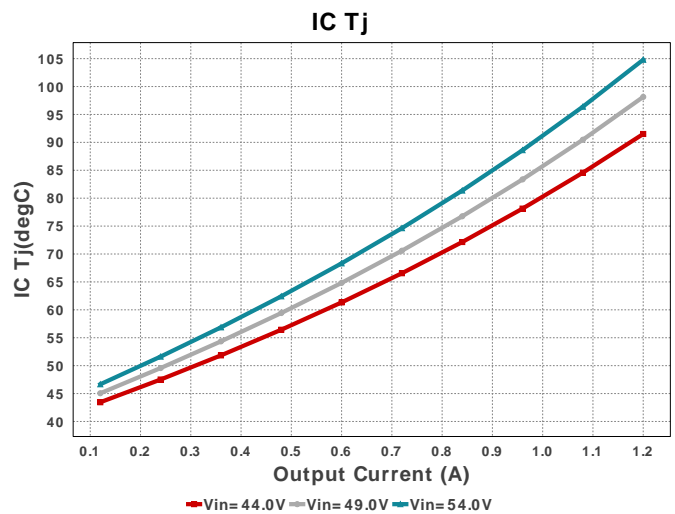
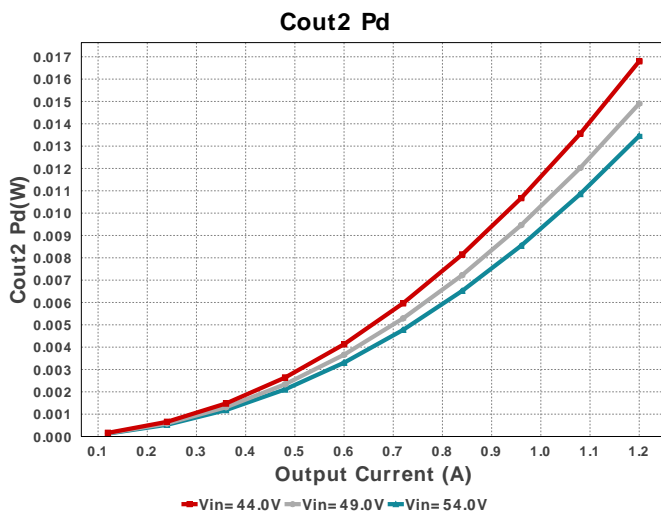

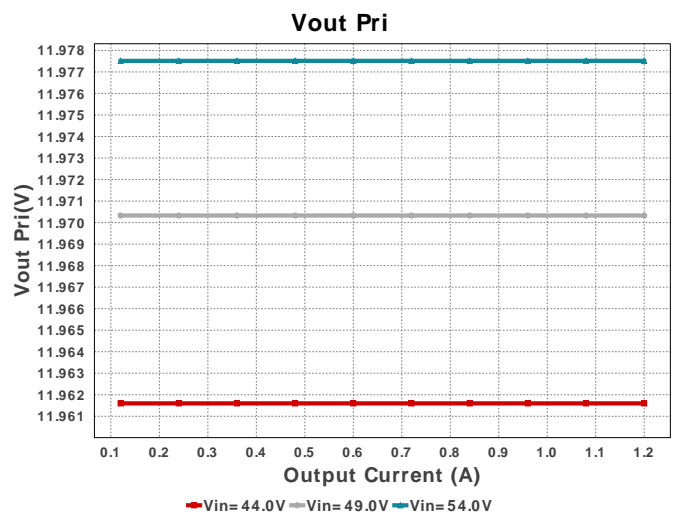
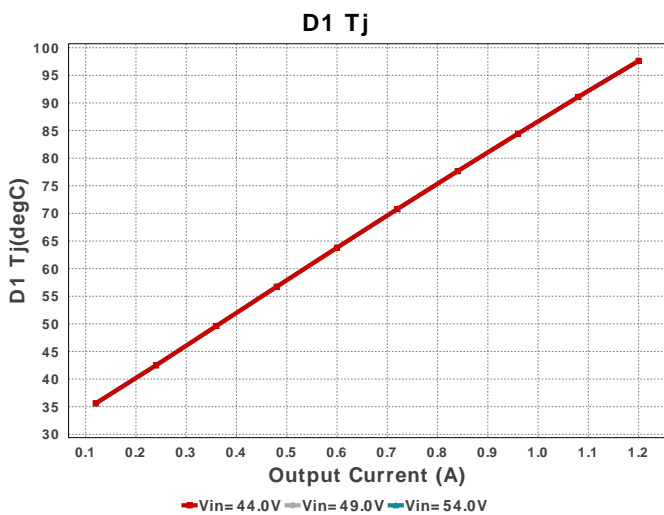
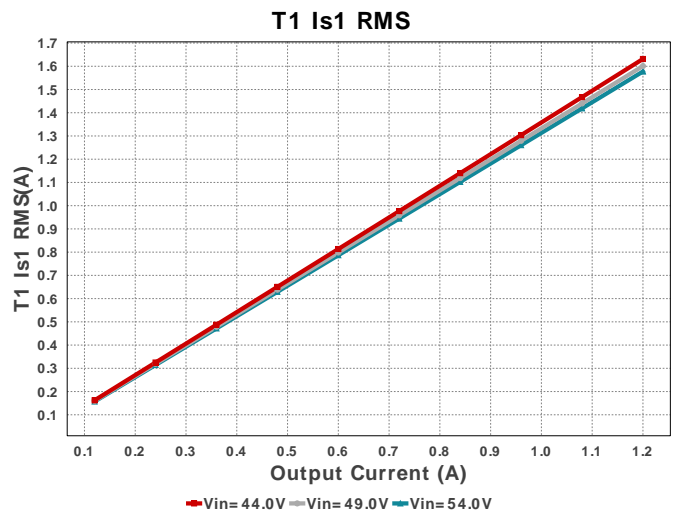
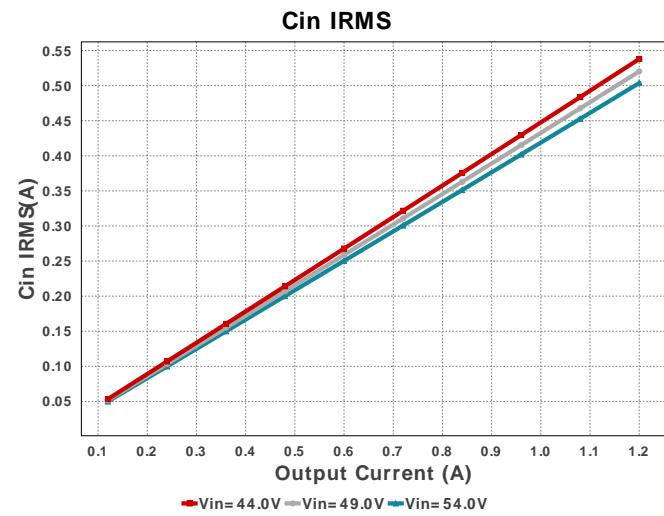
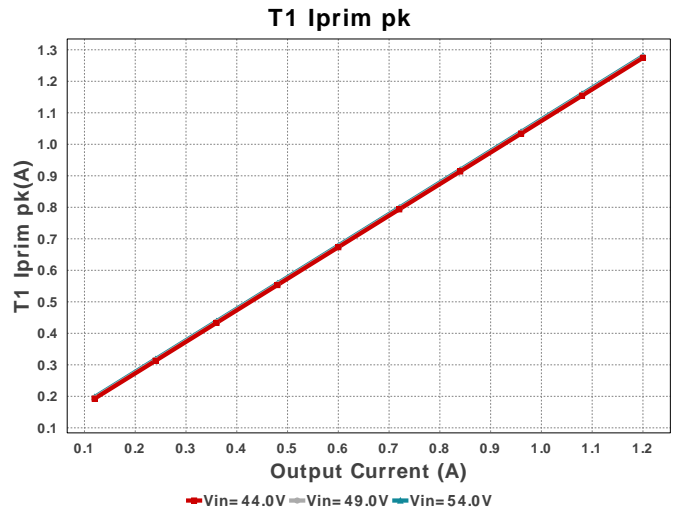
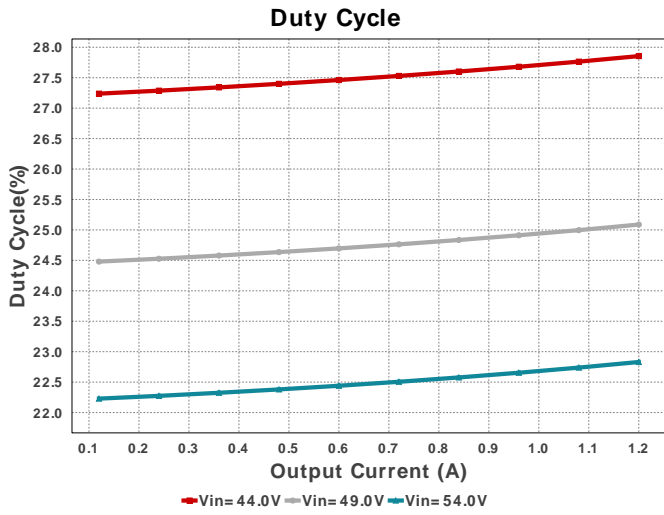

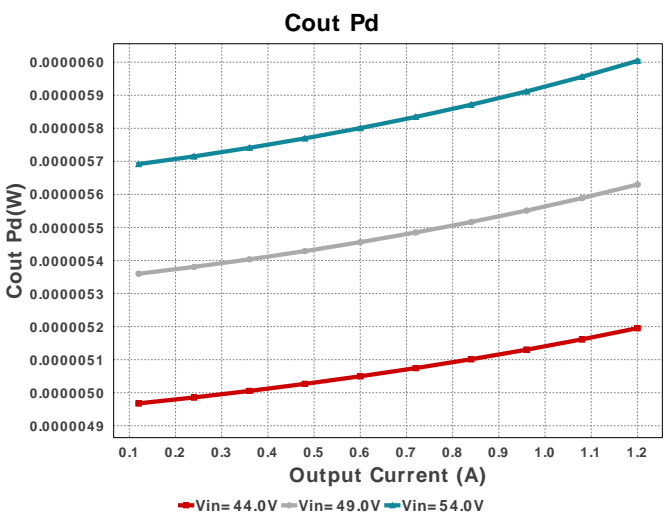
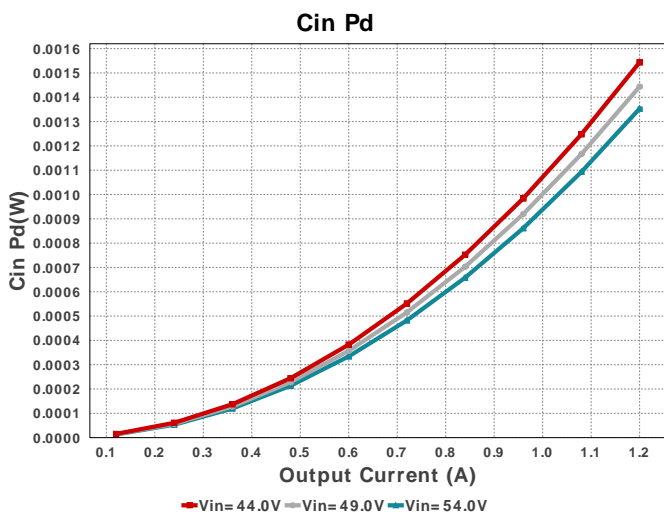
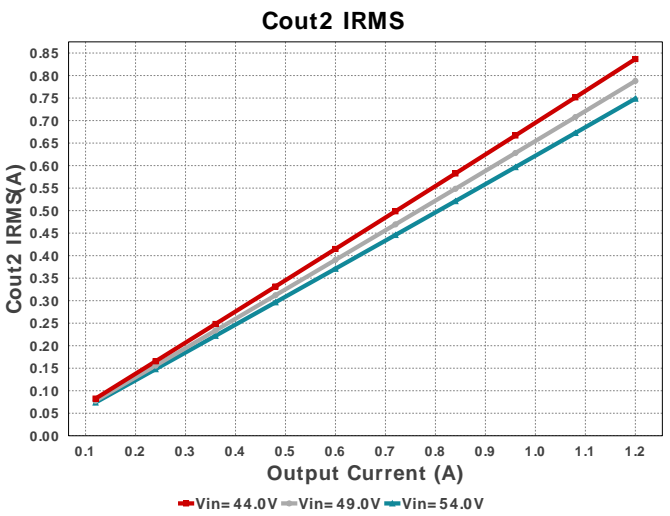
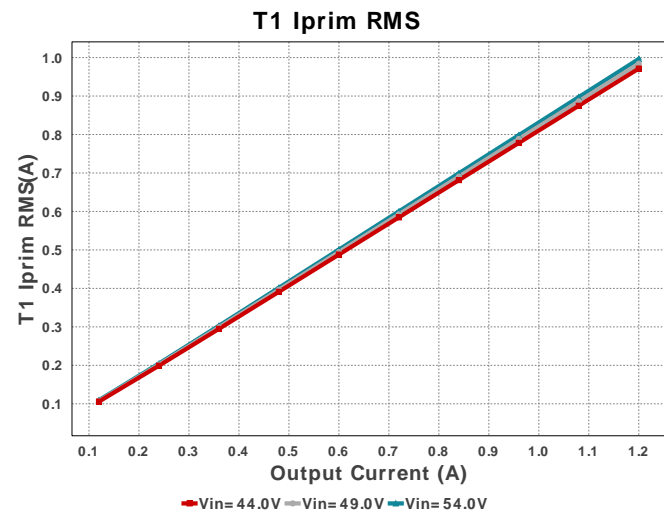
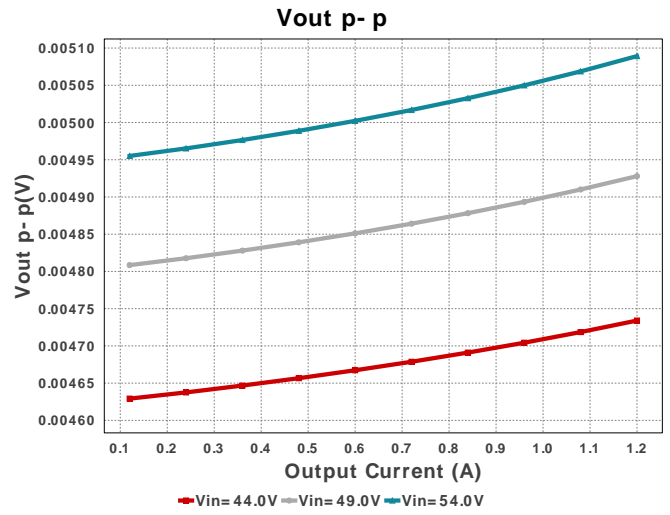
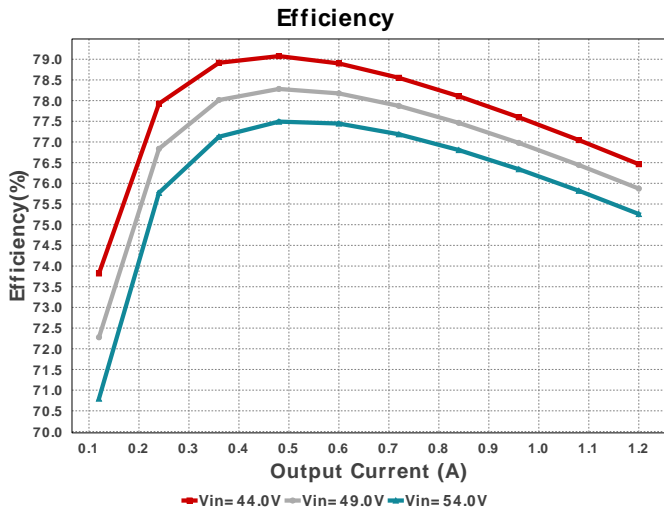

Xformer Pd

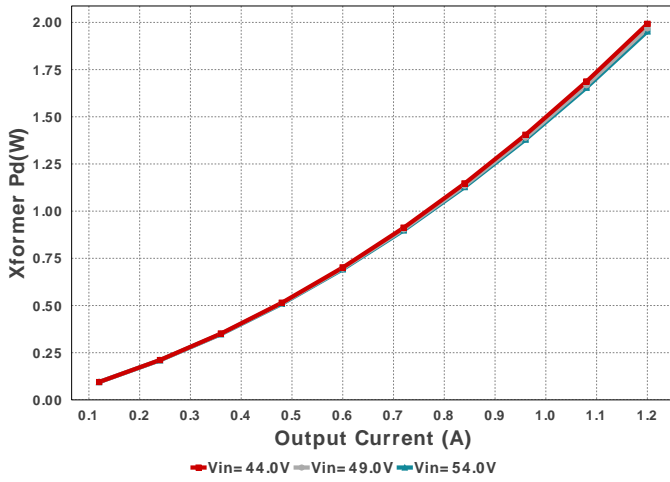

Vout Iso

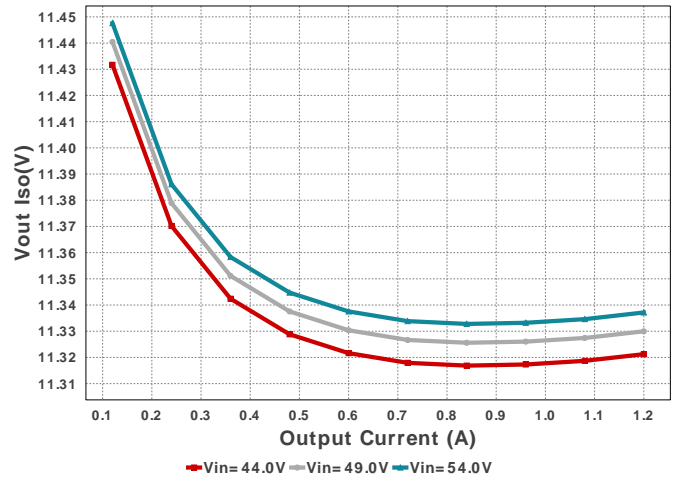

Iin Avg

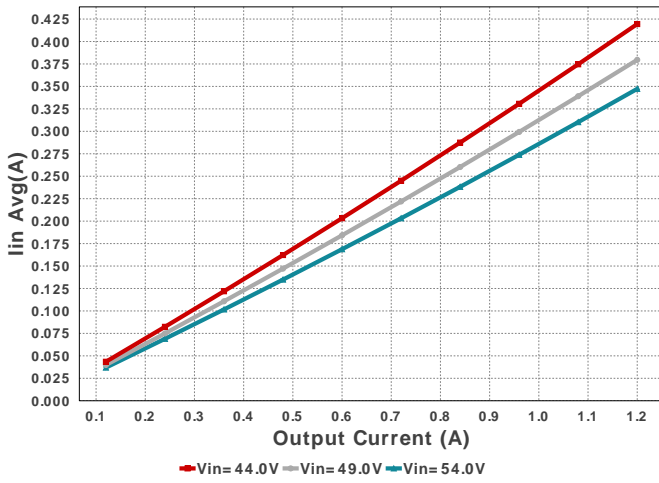

Iiso

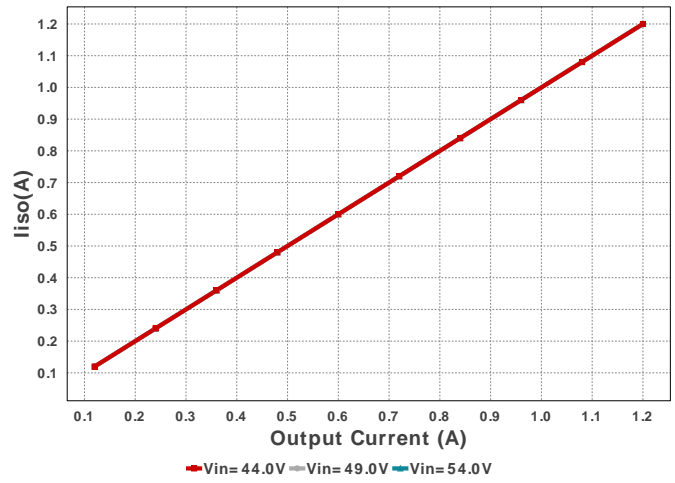

Total Pd

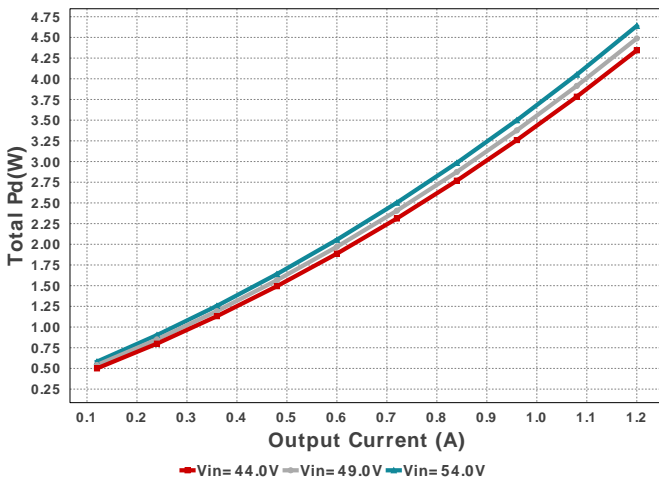

Cout IRMS

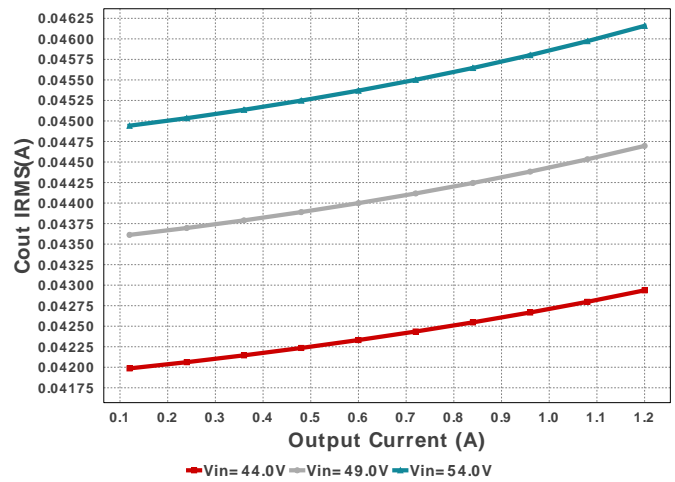

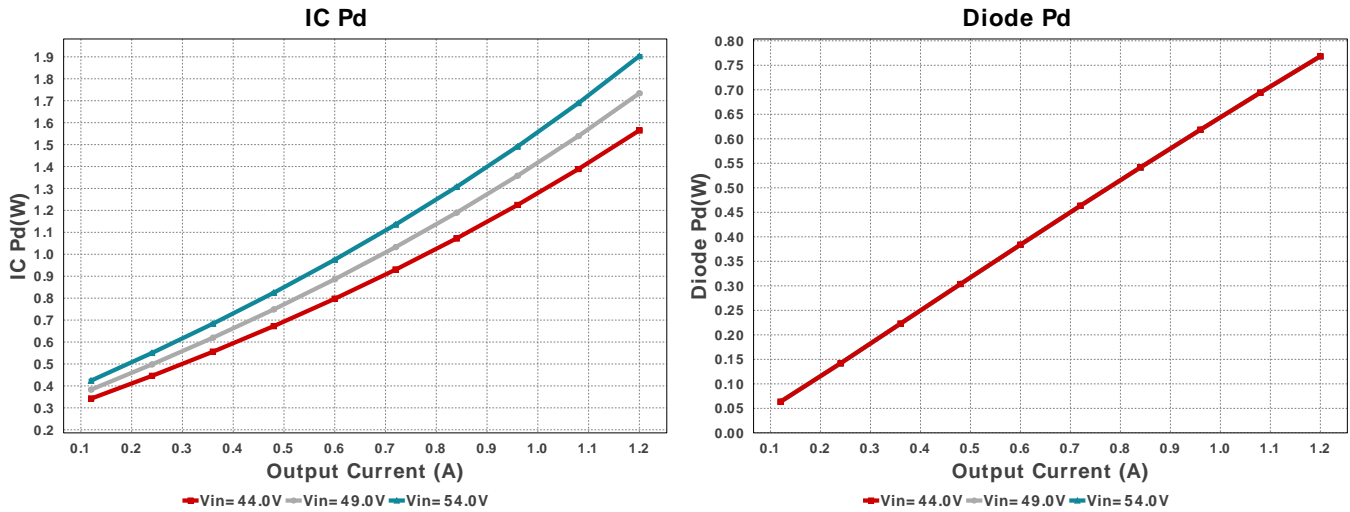

## Operating Values

#	Name	Value	Category	Description
1.	Cin IRMS	503.686 mA	Capacitor	Input capacitor RMS ripple current
2.	Cin Pd	1.353 mW	Capacitor	Input capacitor power dissipation
3.	Cout IRMS	46.158 mA	Capacitor	Output capacitor RMS ripple current
4.	Cout Pd	5.768 $\mu$ W	Capacitor	Output capacitor power dissipation
5.	Cout2 IRMS	748.789 mA	Capacitor	Output capacitor2 RMS ripple current
6.	Cout2 Pd	13.459 mW	Capacitor	Output capacitor2 power dissipation
7.	Iiso	1.2 A	Current	Secondary Side Output Current
8.	D1 Tj	97.622 degC	Diode	D1 junction temperature
9.	Diode Pd	756.11 mW	Diode	Diode power dissipation
10.	IC Pd	1.934 W	IC	IC power dissipation
11.	IC Tj	104.804 degC	IC	IC junction temperature
12.	ICThetaJA	39.3 degC/W	IC	IC junction-to-ambient thermal resistance
13.	Iin Avg	347.25 mA	IC	Average input current
14.	Vout Iso	11.337 V	Op Point	Secondary Side Output Voltage
15.	Vout Pri	11.978 V	Op Point	Primary Side Output Voltage
16.	Cin Pd	1.353 mW	Power	Input capacitor power dissipation
17.	Cout Pd	6.004 $\mu$ W	Power	Output capacitor power dissipation
18.	Cout2 Pd	13.456 mW	Power	Output capacitor2 power dissipation
19.	Diode Pd	768.44 mW	Power	Diode power dissipation
20.	IC Pd	1.903 W	Power	IC power dissipation
21.	Total Pd	4.639 W	Power	Total Power Dissipation
22.	Xformer Pd	1.953 W	Power	Transformer power dissipation
23.	BOM Count	18	System	Total Design BOM count
24.	Duty Cycle	22.83 %	System Information	Duty cycle
25.	Efficiency	75.258 %	System Information	Steady state efficiency
26.	FootPrint	489.0 mm <sup>2</sup>	System Information	Total Foot Print Area of BOM components
27.	Frequency	600.0 kHz	System Information	Switching frequency
28.	Total BOM	\$4.56	System Information	Total BOM Cost
29.	Vin	54.0 V	System Information	Vin operating point
30.	Vout Actual	11.76 V	System Information	Vout Actual calculated based on selected voltage divider resistors
31.	Vout Tolerance	2.948 %	System Information	Vout Tolerance based on IC Tolerance (no load) and voltage divider resistors if applicable
32.	Vout p-p	5.089 mV	System Information	Peak-to-peak output ripple voltage
33.	T1 Iprim RMS	996.319 mA	Transformer	Transformer Primary RMS Current
34.	T1 Iprim pk	1.28 A	Transformer	Transformer Primary Peak Current
35.	T1 Is1 RMS	1.577 A	Transformer	Transformer Secondary1 RMS Current
36.	Xformer Pd	1.273 W	Transformer	Transformer power dissipation

## Design Inputs

Name	Value	Description
Iout	1.2	Maximum Output Current
VinMax	54.0	Maximum input voltage

---

Name	Value	Description
VinMin	44.0	Minimum input voltage
Vout	12.0	Output Voltage
base_pn	LM5160-Q1	Base Product Number
source	DC	Input Source Type
Ta	30.0	Ambient temperature



## WEBENCH® Assembly

### Component Testing

Some published data on components in datasheets such as Capacitor ESR and Inductor DC resistance is based on conservative values that will guarantee that the components always exceed the specification. For design purposes it is usually better to work with typical values. Since this data is not always available it is a good practice to measure the Capacitance and ESR values of  $C_{in}$  and  $C_{out}$ , and the inductance and DC resistance of  $L1$  before assembly of the board. Any large discrepancies in values should be electrically simulated in WEBENCH to check for instabilities and thermally simulated in WebTHERM to make sure critical temperatures are not exceeded.

### Soldering Component to Board

If board assembly is done in house it is best to tack down one terminal of a component on the board then solder the other terminal. For surface mount parts with large tabs, such as the DPAK, the tab on the back of the package should be pre-tinned with solder, then tacked into place by one of the pins. To solder the tab down to the board place the iron down on the board while resting against the tab, heating both surfaces simultaneously. Apply light pressure to the top of the plastic case until the solder flows around the part and the part is flush with the PCB. If the solder is not flowing around the board you may need a higher wattage iron (generally 25W to 30W is enough).

### Initial Startup of Circuit

It is best to initially power up the board by setting the input supply voltage to the lowest operating input voltage 44.0V and set the input supply's current limit to zero. With the input supply off connect up the input supply to  $V_{in}$  and GND. Connect a digital volt meter and a load if needed to set the minimum load of the design from  $V_{out}$  and GND. Turn on the input supply and slowly turn up the current limit on the input supply. If the voltage starts to rise on the input supply continue increasing the input supply current limit while watching the output voltage. If the current increases on the input supply, but the voltage remains near zero, then there may be a short or a component misplaced on the board. Power down the board and visually inspect for solder bridges and recheck the diode and capacitor polarities. Once the power supply circuit is operational then more extensive testing may include full load testing, transient load and line tests to compare with simulation results.

### Load Testing

The setup is the same as the initial startup, except that an additional digital voltmeter is connected between  $V_{in}$  and GND, a load is connected between  $V_{out}$  and GND and a current meter is connected in series between  $V_{out}$  and the load. The load must be able to handle at least rated output power + 50% ( 7.5 watts for this design). Ideally the load is supplied in the form of a variable load test unit. It can also be done in the form of suitably large power resistors. When using an oscilloscope to measure waveforms on the prototype board, the ground leads of the oscilloscope probes should be as short as possible and the area of the loop formed by the ground lead should be kept to a minimum. This will help reduce ground lead inductance and eliminate EMI noise that is not actually present in the circuit.



### Design Assistance

1. For a Constant On Time device to be stable, we need to provide a ripple at the feedback comparator. There are various methods to implement the ripple. Depending on the circuit complexity vs. the allowable ripple, we have three options to choose from. The simplest option, 'Low Complexity', would require only a high ESR cap at the output. This means that the BOM count will be small, but the output voltage ripple will be quite large. The 'Optimal Solution' would require a feed-forward cap in parallel with the upper feedback resistor to AC couple the ripple to the feedback node. This increases the BOM count slightly, but now we have more control over the output voltage ripple. If the output voltage requirement is very tight, then the best option is to go for the 'Low Output Ripple' solution. In this option we can go with very low ESR output caps and have very good control over the output voltage ripple.

2. The LM5160-Q1 is qualified for Automotive applications. All passives and other components selected in this design may not be qualified for Automotive applications. The user is required to verify that all components in the design meet the qualification and safety requirements for their specific application

3. Master key : 367A9DEDF30391D0[v1]

4. **LM5160-Q1** Product Folder : <http://www.ti.com/product/LM5160%2DQ1> : contains the data sheet and other resources.



**Important Notice and Disclaimer**

TI provides technical and reliability data (including datasheets), design resources (including reference designs), application or other design advice, web tools, safety information, and other resources AS IS and with all faults, and disclaims all warranties. These resources are intended for skilled developers designing with TI products. You are solely responsible for (1) selecting the appropriate TI products for your application, (2) designing, validating and testing your application, and (3) ensuring your application meets applicable standards, and any other safety, security, or other requirements.

These resources are subject to change without notice. TI grants you permission to use these resources only for development of an application that uses the TI products described in the resource. Other reproduction and display of these resources is prohibited. No license is granted to any other TI intellectual property right or to any third party intellectual property right. TI disclaims responsibility for, and you will fully indemnify TI and its representatives against, any claims, damages, costs, losses, and liabilities arising out of your use of these resources.

Providing these resources does not expand or otherwise alter TI's applicable Terms of Sale or other applicable terms available either on ti.com or provided in conjunction with TI products.