

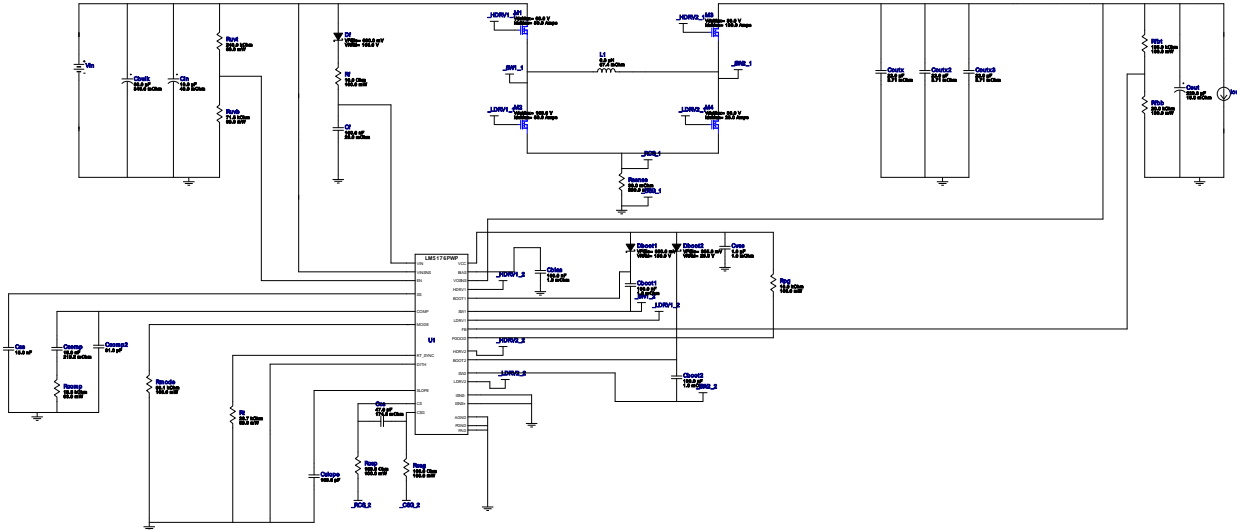

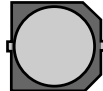















WEBENCH® Design Report

 Design : 34 LM5176PWPR
 LM5176PWPR 6V-36V to 5.00V @ 2A

Electrical BOM

Name	Manufacturer	Part Number	Properties	Qty	Price	Footprint
Cbias	MuRata	GRM155R71A104KA01D Series= X7R	Cap= 100.0 nF ESR= 1.0 mOhm VDC= 10.0 V IRMS= 0.0 A	1	\$0.01	0402 3 mm ²
Cboot1	Kemet	C0603C104Z3VACTU Series= Y5V	Cap= 100.0 nF ESR= 1.0 mOhm VDC= 25.0 V IRMS= 0.0 A	1	\$0.01	0603 5 mm ²
Cboot2	Kemet	C0603C104Z3VACTU Series= Y5V	Cap= 100.0 nF ESR= 1.0 mOhm VDC= 25.0 V IRMS= 0.0 A	1	\$0.01	0603 5 mm ²
Cbulk	Nichicon	UUD1H680MNL1GS Series= uD	Cap= 68.0 uF ESR= 340.0 mOhm VDC= 50.0 V IRMS= 300.0 mA	1	\$0.19	 SM_RADIAL_8MM 113 mm ²
Ccomp	TDK	CGA2B3X7R1H153K050BB Series= X7R	Cap= 15.0 nF ESR= 216.2 mOhm VDC= 50.0 V IRMS= 379.39 mA	1	\$0.01	0402 3 mm ²
Ccomp2	Samsung Electro-Mechanics	CL21C910JBANNNC Series= C0G/NP0	Cap= 91.0 pF VDC= 50.0 V IRMS= 0.0 A	1	\$0.01	0805 7 mm ²
Ccs	AVX	06035A470JAT2A Series= C0G/NP0	Cap= 47.0 pF ESR= 174.0 mOhm VDC= 50.0 V IRMS= 0.0 A	1	\$0.01	0603 5 mm ²
Cf	TDK	CGA3E2X7R1H104K080AA Series= X7R	Cap= 100.0 nF ESR= 29.6 mOhm VDC= 50.0 V IRMS= 971.99 mA	1	\$0.01	0603 5 mm ²

Name	Manufacturer	Part Number	Properties	Qty	Price	Footprint
Cin	Panasonic	50SVPF10M Series= SVPF	Cap= 10.0 uF ESR= 40.0 mOhm VDC= 50.0 V IRMS= 2.5 A	1	\$0.38	 CAPSMT_62_F61 74 mm ²
Cout	Panasonic	6SVPE220MW Series= SVPE	Cap= 220.0 uF ESR= 15.0 mOhm VDC= 6.3 V IRMS= 3.15 A	1	\$0.20	 CAPSMT_62_E61 53 mm ²
Coutx	TDK	C1608X5R1A226M080AC Series= X5R	Cap= 22.0 uF ESR= 3.71 mOhm VDC= 10.0 V IRMS= 2.69936 A	1	\$0.13	 0603 5 mm ²
Coutx2	TDK	C1608X5R1A226M080AC Series= X5R	Cap= 22.0 uF ESR= 3.71 mOhm VDC= 10.0 V IRMS= 2.69936 A	1	\$0.13	 0603 5 mm ²
Coutx3	TDK	C1608X5R1A226M080AC Series= X5R	Cap= 22.0 uF ESR= 3.71 mOhm VDC= 10.0 V IRMS= 2.69936 A	1	\$0.13	 0603 5 mm ²
Cslope	Samsung Electro-Mechanics	CL10C101JB8NNNC Series= C0G/NP0	Cap= 100.0 pF VDC= 50.0 V IRMS= 0.0 A	1	\$0.01	 0603 5 mm ²
Css	Kemet	C0603C153J3GACTU Series= C0G/NP0	Cap= 15.0 nF VDC= 25.0 V IRMS= 0.0 A	1	\$0.11	 0603 5 mm ²
Cvcc	Taiyo Yuden	EMK107B7105KA-T Series= X7R	Cap= 1.0 uF ESR= 1.0 mOhm VDC= 16.0 V IRMS= 0.0 A	1	\$0.02	 0603 5 mm ²
Dboot1	SMC Diode Solutions	SK215ATR	VF@Io= 950.0 mV VRRM= 150.0 V	1	\$0.04	 SMA 37 mm ²
Dboot2	Comchip Technology	CDBK0520L-HF	VF@Io= 385.0 mV VRRM= 20.0 V	1	\$0.07	 SOD-123F 12 mm ²
Df	International Rectifier	10MQ100NTRPBF	VF@Io= 680.0 mV VRRM= 100.0 V	1	\$0.10	 SMA 37 mm ²
L1	Coilcraft	XAL4030-682MEB	L= 6.8 uH 67.4 mOhm	1	\$0.72	 XAL4030 25 mm ²
M1	Texas Instruments	CSD18537NQ5A	VdsMax= 60.0 V IdsMax= 50.0 Amps	1	\$0.28	 TRANS_NexFET_Q5A 55 mm ²
M2	Texas Instruments	CSD19534Q5A	VdsMax= 100.0 V IdsMax= 50.0 Amps	1	\$0.34	 TRANS_NexFET_Q5A 55 mm ²
M3	Texas Instruments	CSD17310Q5A	VdsMax= 30.0 V IdsMax= 100.0 Amps	1	\$0.31	 TRANS_NexFET_Q5A 55 mm ²
M4	Texas Instruments	CSD17579Q5A	VdsMax= 30.0 V IdsMax= 25.0 Amps	1	\$0.19	 TRANS_NexFET_Q5A 55 mm ²
Rcomp	Vishay-Dale	CRCW040213K3FKED Series= CRCW...e3	Res= 13.3 kOhm Power= 63.0 mW Tolerance= 1.0%	1	\$0.01	 0402 3 mm ²

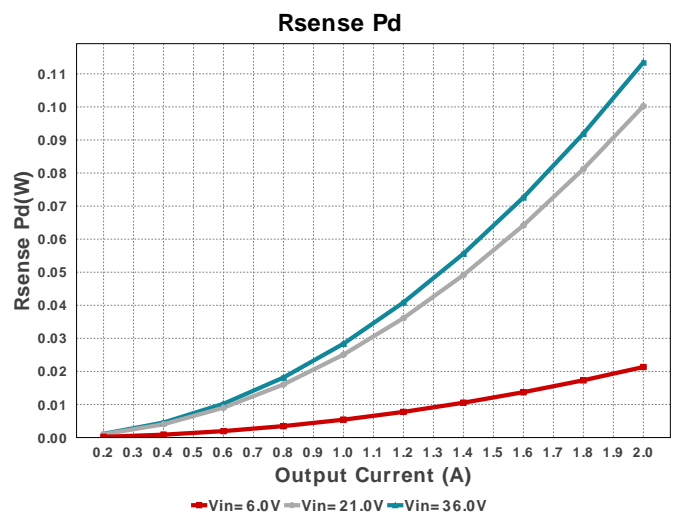
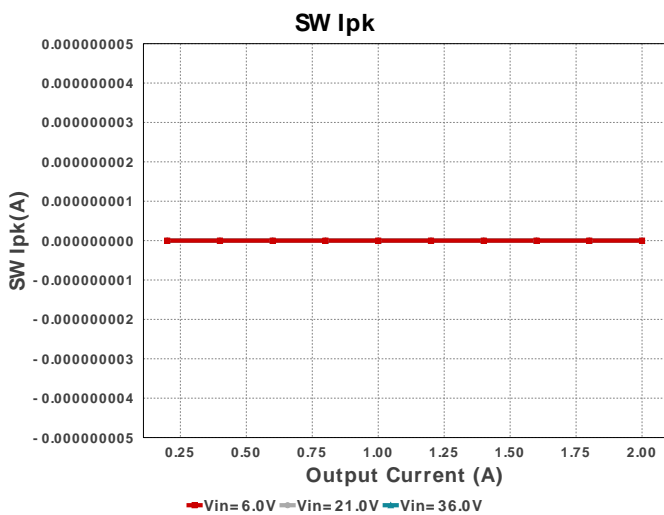
Name	Manufacturer	Part Number	Properties	Qty	Price	Footprint
Rcsg	Yageo	RC0603FR-07100RL Series= ?	Res= 100.0 Ohm Power= 100.0 mW Tolerance= 1.0%	1	\$0.01	0603 5 mm ²
Rcsp	Yageo	RC0603FR-07100RL Series= ?	Res= 100.0 Ohm Power= 100.0 mW Tolerance= 1.0%	1	\$0.01	0603 5 mm ²
Rf	Yageo	RC0603FR-0710RL Series= ?	Res= 10.0 Ohm Power= 100.0 mW Tolerance= 1.0%	1	\$0.01	0603 5 mm ²
Rfbb	Yageo	RC0603FR-0720KL Series= ?	Res= 20.0 kOhm Power= 100.0 mW Tolerance= 1.0%	1	\$0.01	0603 5 mm ²
Rfbt	Vishay-Dale	CRCW0603105KFKEA Series= CRCW..e3	Res= 105.0 kOhm Power= 100.0 mW Tolerance= 1.0%	1	\$0.01	0603 5 mm ²
Rmode	Vishay-Dale	CRCW060393K1FKEA Series= CRCW..e3	Res= 93.1 kOhm Power= 100.0 mW Tolerance= 1.0%	1	\$0.01	0603 5 mm ²
Rpg	Yageo	RC0603FR-0710KL Series= ?	Res= 10.0 kOhm Power= 100.0 mW Tolerance= 1.0%	1	\$0.01	0603 5 mm ²
Rsense	Panasonic	ERJ-L14KF33MU Series= ERJ-L14	Res= 33.0 mOhm Power= 330.0 mW Tolerance= 1.0%	1	\$0.11	1210 15 mm ²
Rt	Vishay-Dale	CRCW040223K7FKED Series= CRCW..e3	Res= 23.7 kOhm Power= 63.0 mW Tolerance= 1.0%	1	\$0.01	0402 3 mm ²
Ruvb	Vishay-Dale	CRCW040271K5FKED Series= CRCW..e3	Res= 71.5 kOhm Power= 63.0 mW Tolerance= 1.0%	1	\$0.01	0402 3 mm ²
Ruvt	Vishay-Dale	CRCW0402249KFKEA Series= CRCW..e3	Res= 249.0 kOhm Power= 63.0 mW Tolerance= 1.0%	1	\$0.01	0402 3 mm ²
U1	Texas Instruments	LM5176PWPR	Switcher	1	\$3.00	PWP0028C_N 98 mm ²

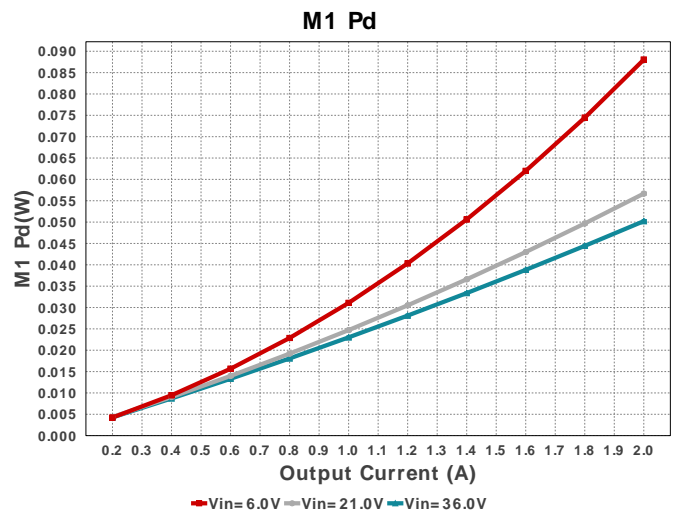
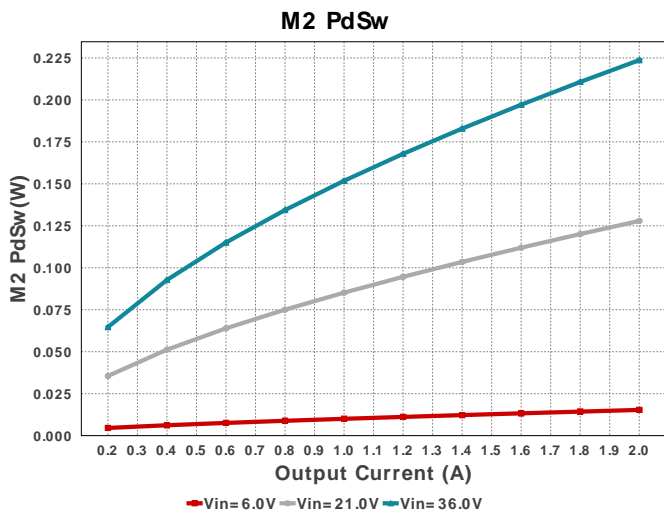
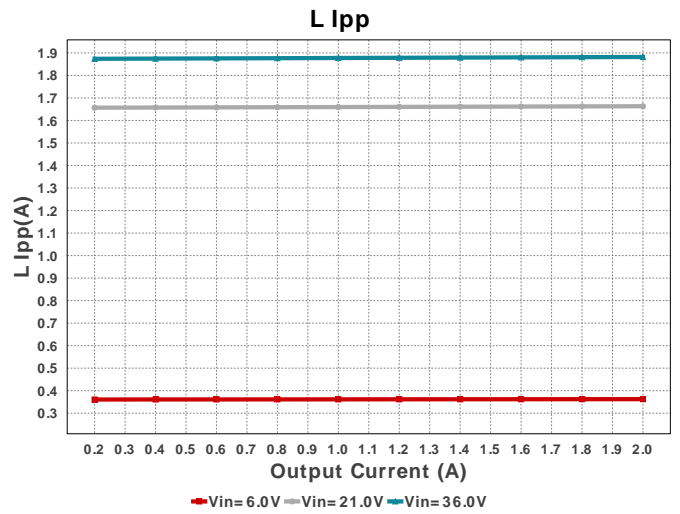
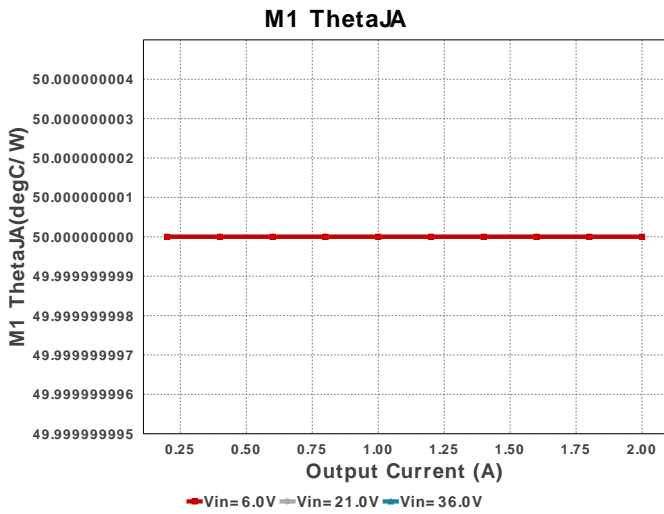
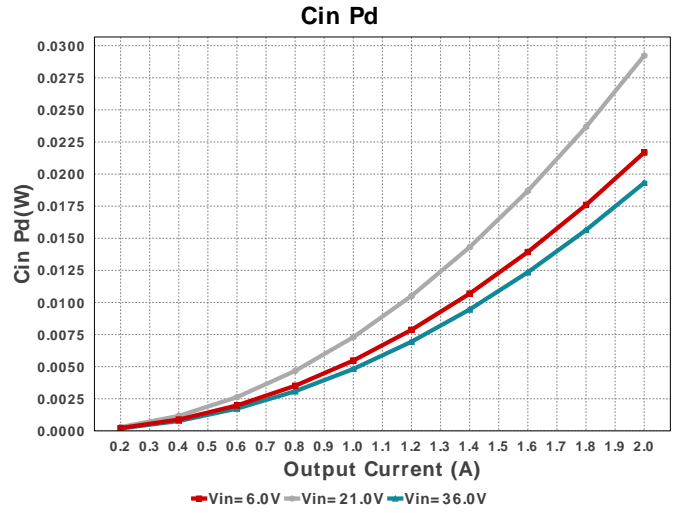
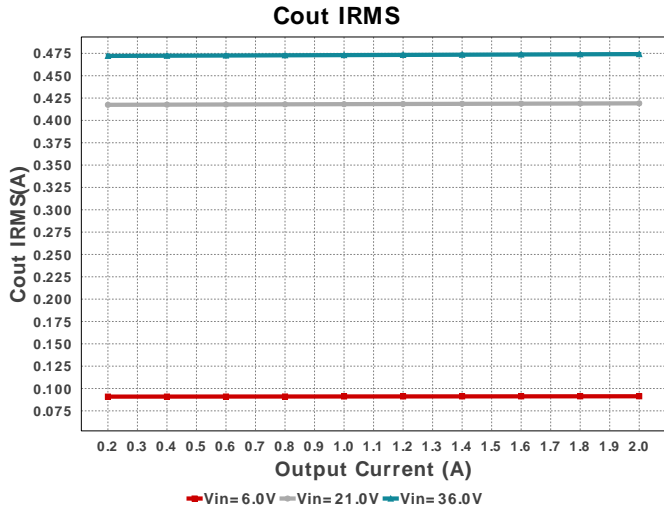



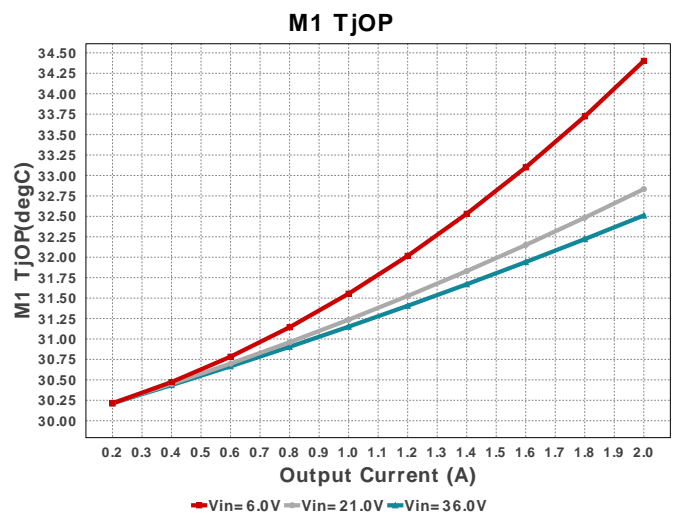
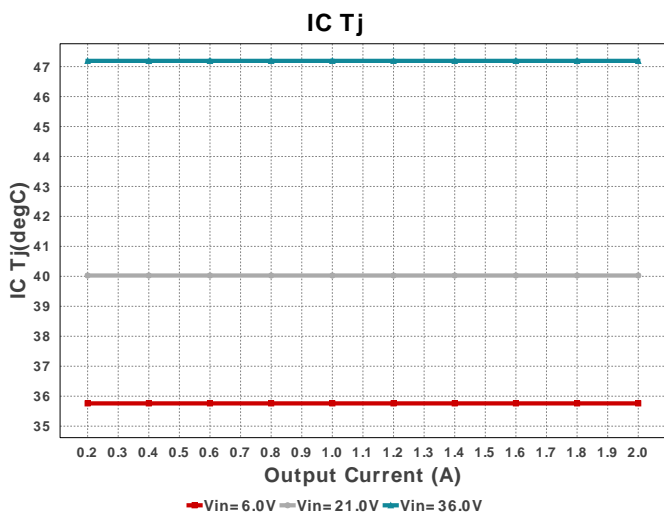
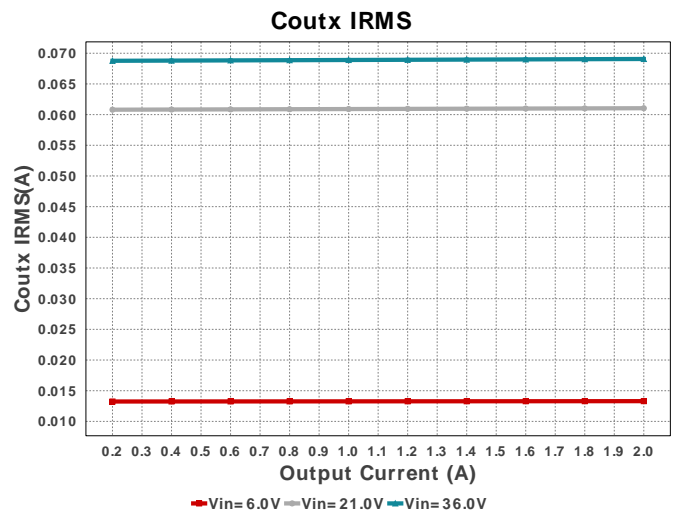
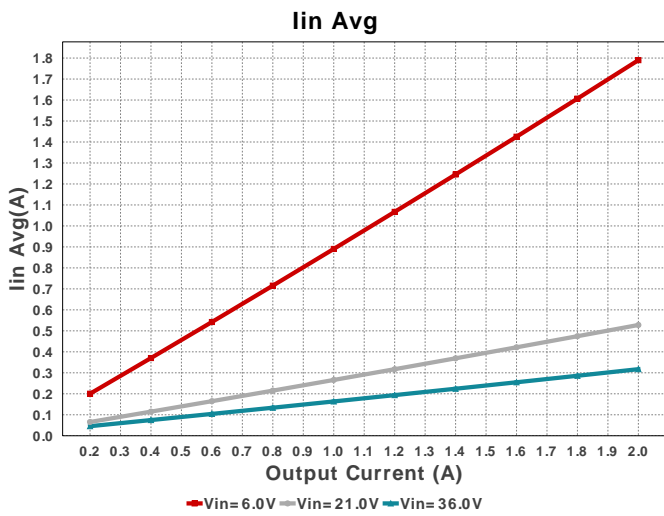
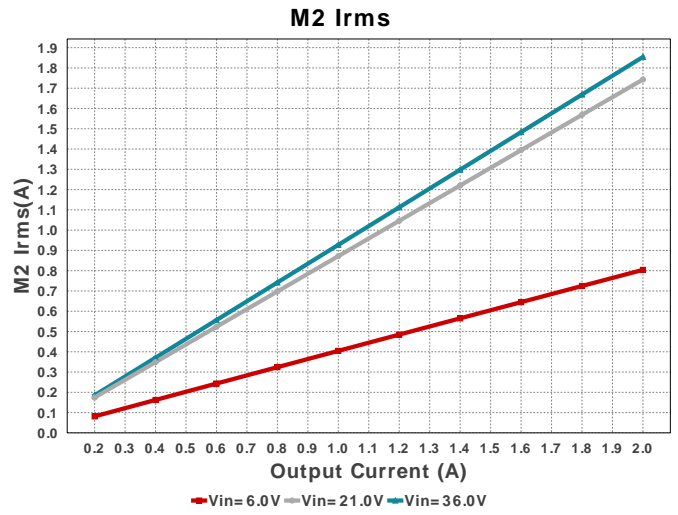
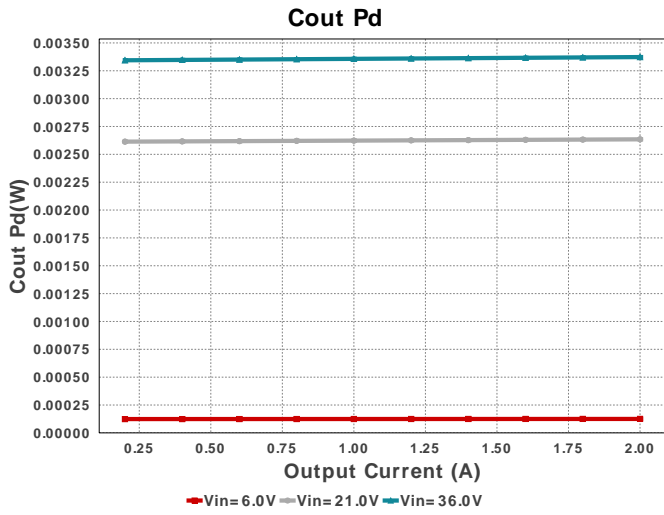

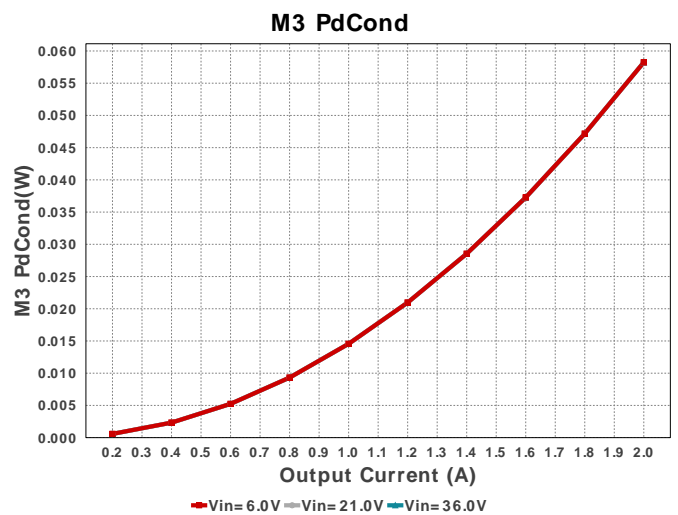
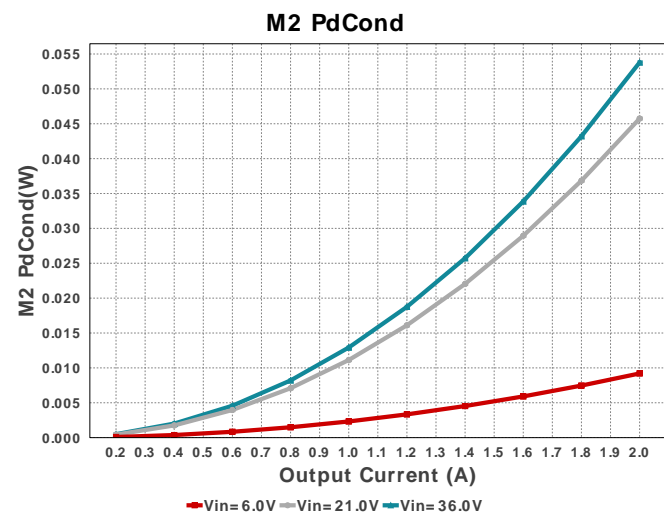
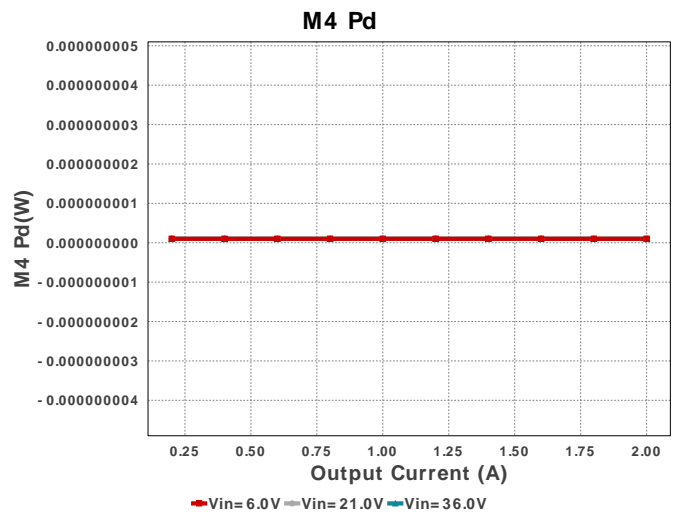
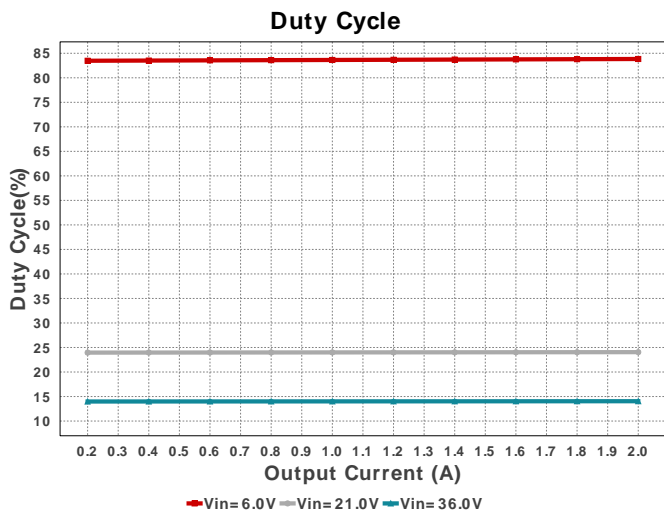
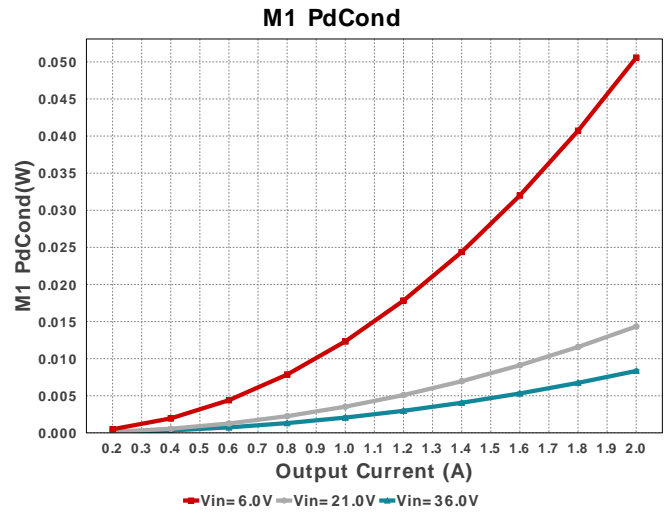
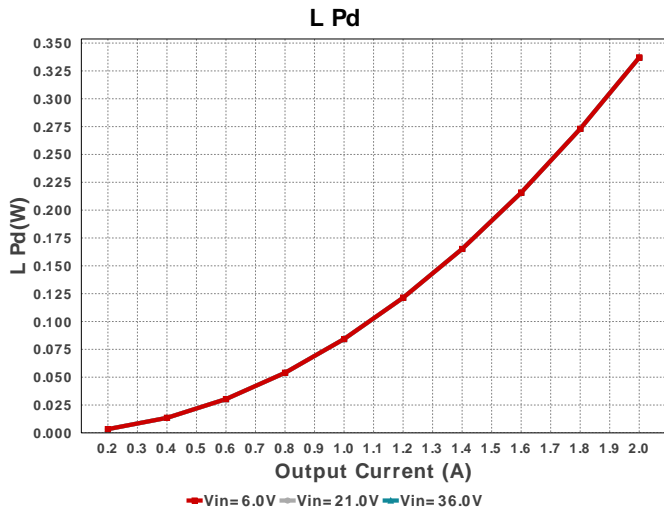

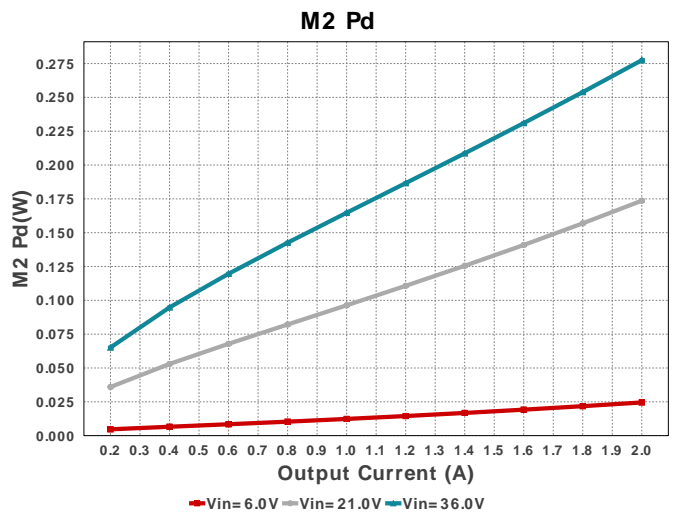
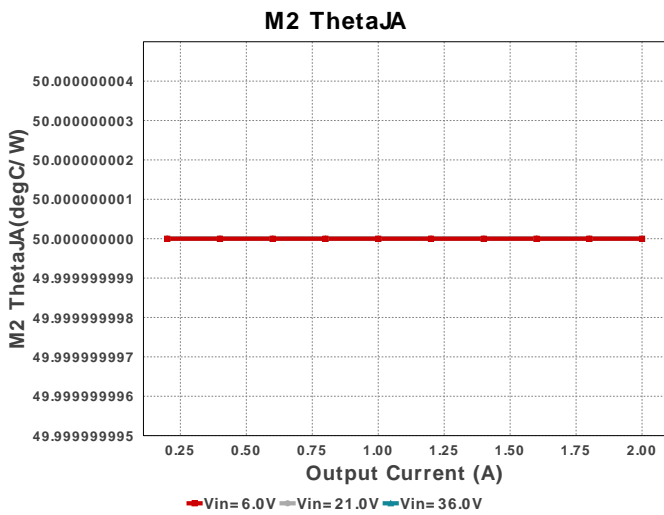
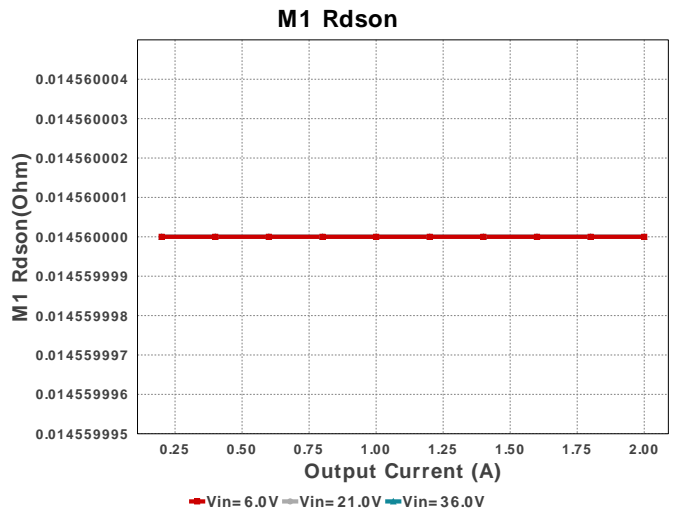
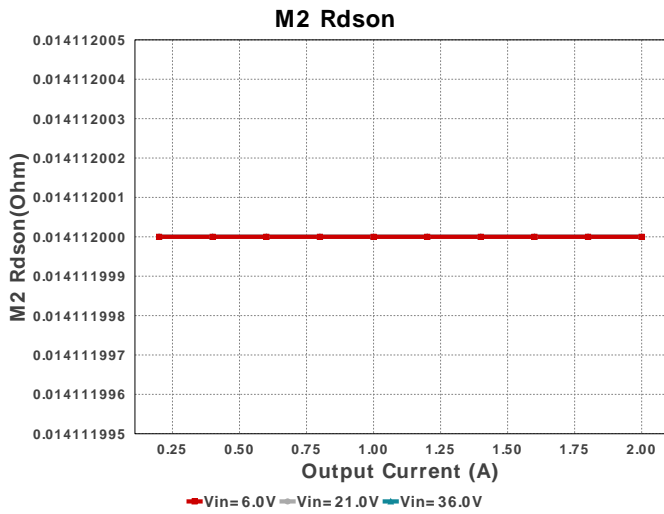
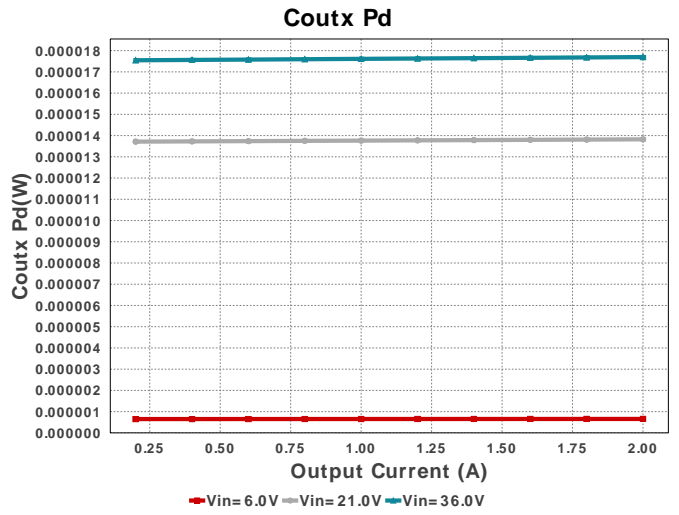
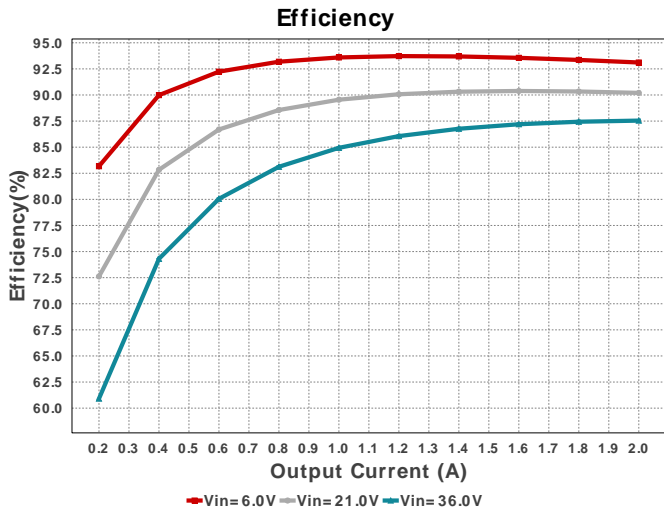

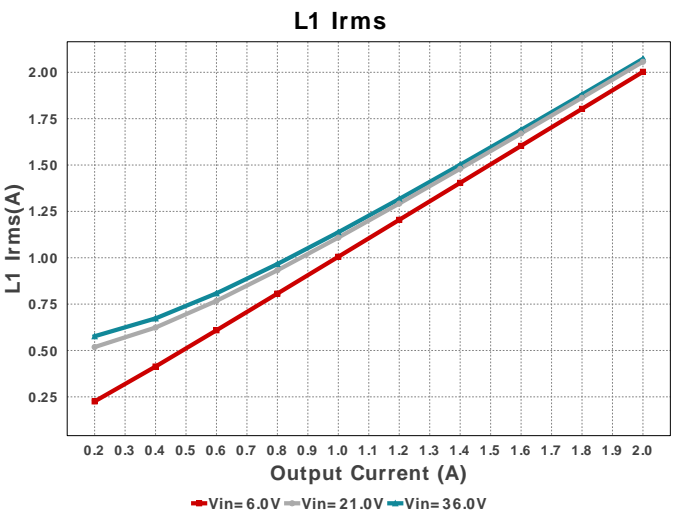
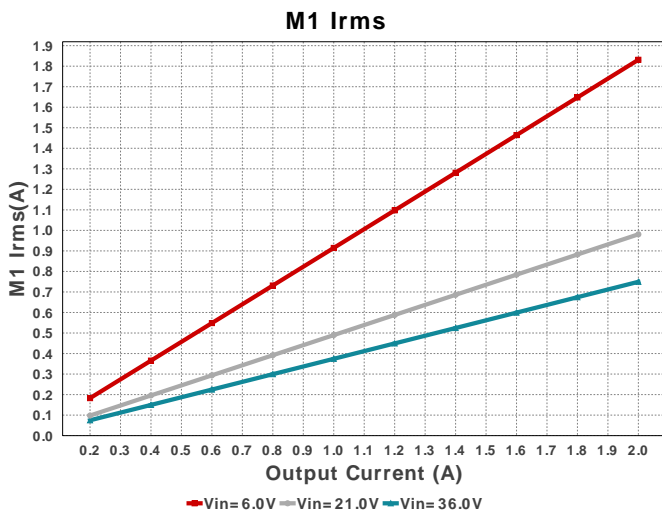
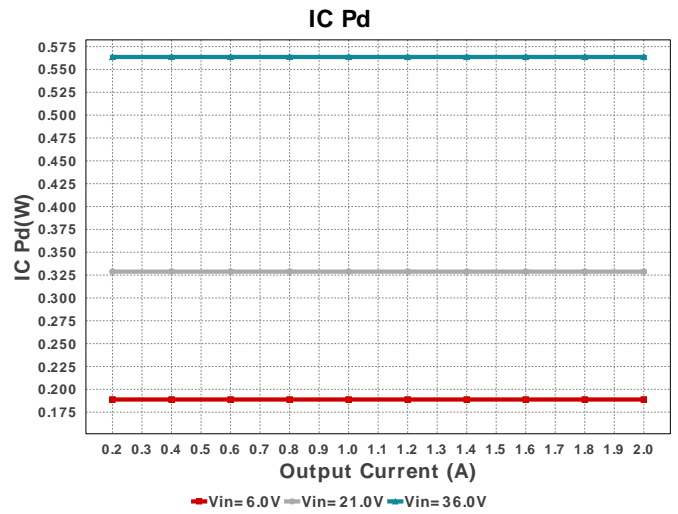
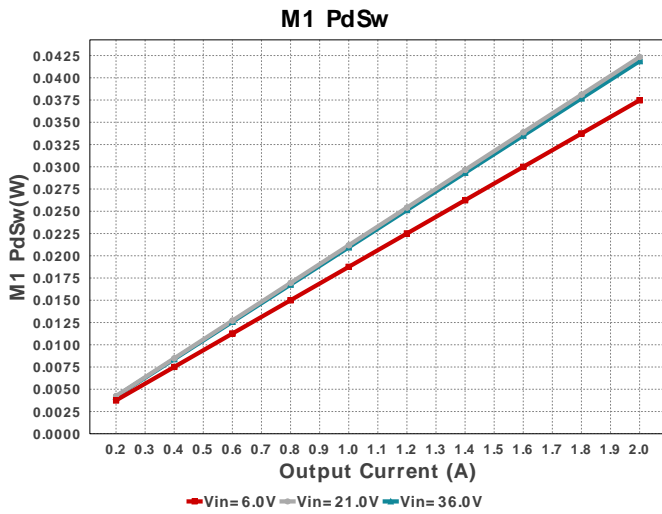
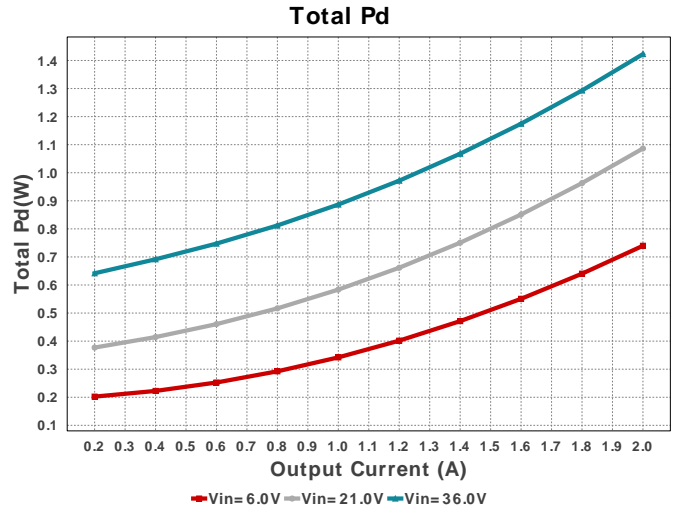
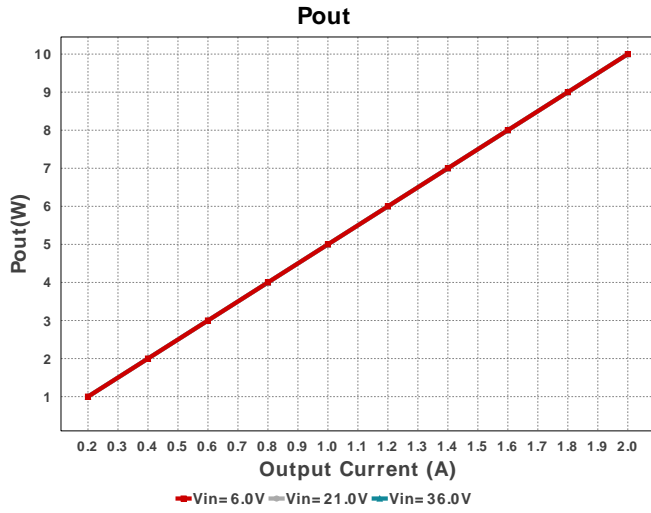

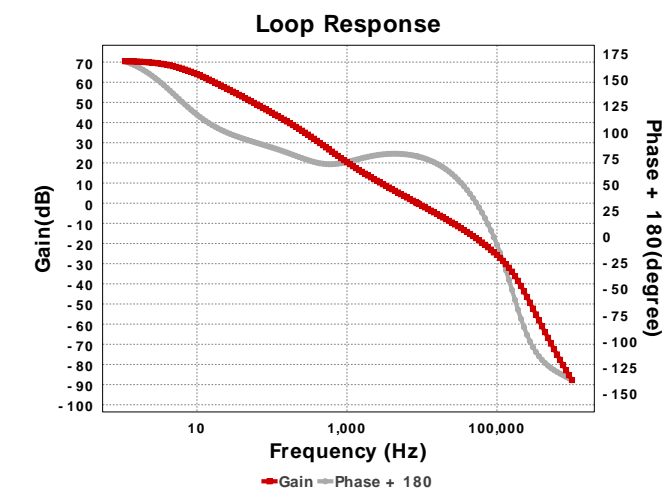
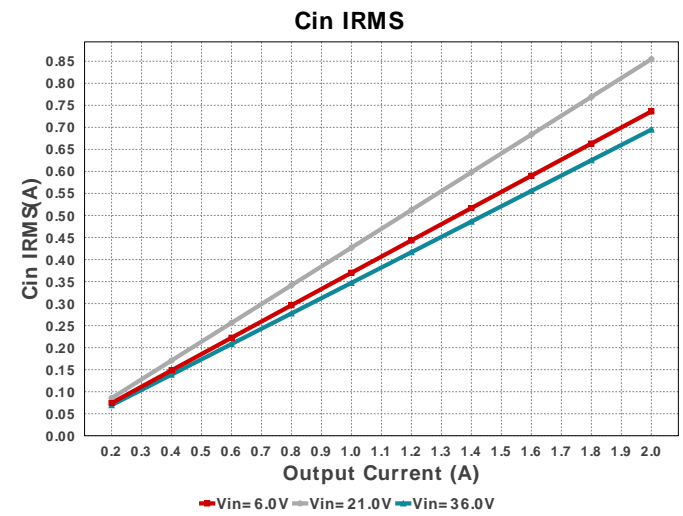
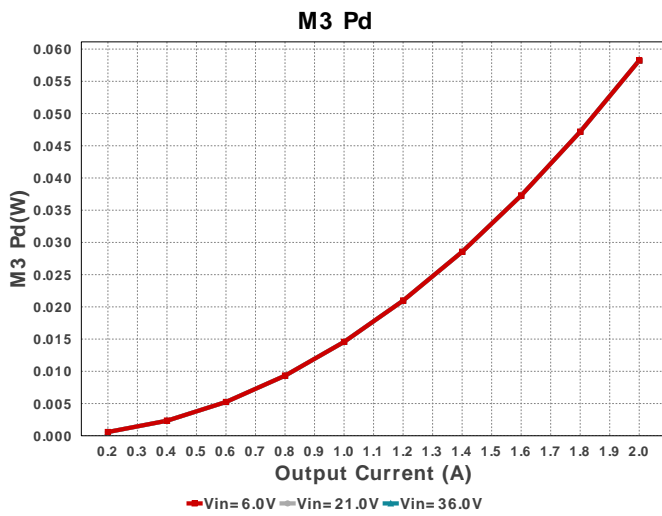
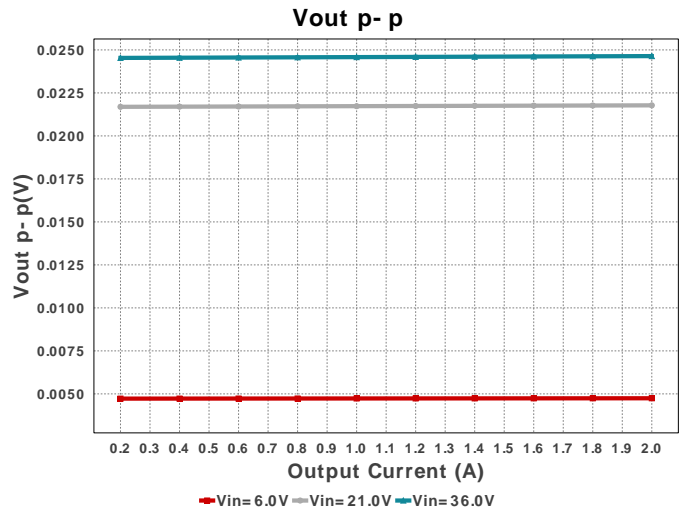
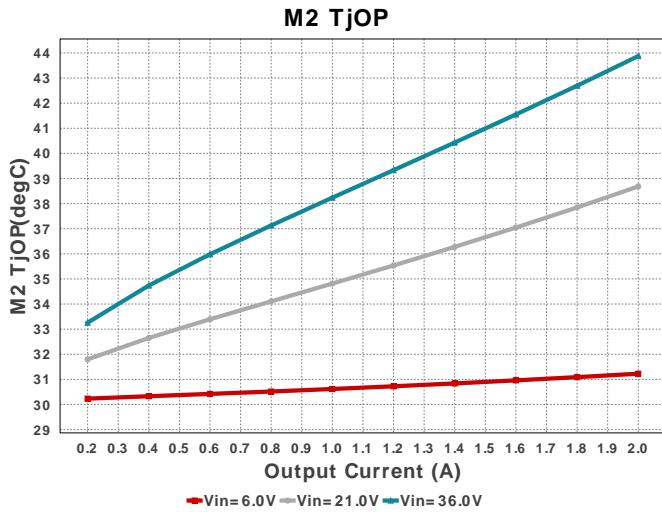

Operating Values

#	Name	Value	Category	Description
1.	Cin IRMS	694.906 mA	Capacitor	Input capacitor RMS ripple current
2.	Cin Pd	19.316 mW	Capacitor	Input capacitor power dissipation
3.	Cout IRMS	473.649 mA	Capacitor	Output capacitor RMS ripple current
4.	Cout Pd	3.365 mW	Capacitor	Output capacitor power dissipation
5.	Coutx IRMS	69.617 mA	Capacitor	Output capacitor_x RMS ripple current
6.	Coutx Pd	17.981 μW	Capacitor	Output capacitor_x power loss
7.	IC Pd	563.63 mW	IC	IC power dissipation
8.	IC Tj	47.191 degC	IC	IC junction temperature
9.	IC Tolerance	0.0 V	IC	IC Feedback Tolerance
10.	ICThetaJA	30.5 degC/W	IC	IC junction-to-ambient thermal resistance
11.	Iin Avg	317.3 mA	IC	Average input current

#	Name	Value	Category	Description
12.	L Ipp	1.882 A	Inductor	Peak-to-peak inductor ripple current
13.	L Pd	337.0 mW	Inductor	Inductor power dissipation
14.	L1 Irms	2.072 A	Inductor	Inductor ripple current
15.	M1 Irms	749.533 mA	Mosfet	MOSFET RMS ripple current
16.	M1 Pd	50.218 mW	Mosfet	MOSFET power dissipation
17.	M1 PdCond	8.346 mW	Mosfet	M1 MOSFET conduction losses
18.	M1 PdSw	41.872 mW	Mosfet	M1 MOSFET switching losses
19.	M1 Rdson	14.56 mOhm	Mosfet	Drain-Source On-resistance
20.	M1 ThetaJA	50.0 degC/W	Mosfet	MOSFET junction-to-ambient thermal resistance
21.	M1 TjOP	32.511 degC	Mosfet	MOSFET junction temperature
22.	M2 Irms	1.854 A	Mosfet	MOSFET RMS ripple current
23.	M2 Pd	277.48 mW	Mosfet	MOSFET power dissipation
24.	M2 PdCond	53.786 mW	Mosfet	M2 MOSFET conduction losses
25.	M2 PdSw	223.69 mW	Mosfet	M2 MOSFET switching losses
26.	M2 Rdson	14.112 mOhm	Mosfet	Drain-Source On-resistance
27.	M2 ThetaJA	50.0 degC/W	Mosfet	MOSFET junction-to-ambient thermal resistance
28.	M2 TjOP	43.874 degC	Mosfet	MOSFET junction temperature
29.	M3 Pd	58.24 mW	Mosfet	M3 MOSFET total power dissipation
30.	M3 PdCond	58.24 mW	Mosfet	M3 MOSFET conduction losses
31.	M4 Pd	100.0 pW	Mosfet	M4 MOSFET total power dissipation
32.	Cin Pd	19.316 mW	Power	Input capacitor power dissipation
33.	Cout Pd	3.365 mW	Power	Output capacitor power dissipation
34.	Coutx Pd	17.981 μW	Power	Output capacitor_x power loss
35.	IC Pd	563.63 mW	Power	IC power dissipation
36.	L Pd	337.0 mW	Power	Inductor power dissipation
37.	M1 Pd	50.218 mW	Power	MOSFET power dissipation
38.	M1 PdCond	8.346 mW	Power	M1 MOSFET conduction losses
39.	M1 PdSw	41.872 mW	Power	M1 MOSFET switching losses
40.	M2 Pd	277.48 mW	Power	MOSFET power dissipation
41.	M2 PdCond	53.786 mW	Power	M2 MOSFET conduction losses
42.	M2 PdSw	223.69 mW	Power	M2 MOSFET switching losses
43.	M3 Pd	58.24 mW	Power	M3 MOSFET total power dissipation
44.	M3 PdCond	58.24 mW	Power	M3 MOSFET conduction losses
45.	M4 Pd	100.0 pW	Power	M4 MOSFET total power dissipation
46.	Rsense Pd	113.46 mW	Power	LED Current Rsns Power Dissipation
47.	Total Pd	1.423 W	Power	Total Power Dissipation
48.	Rsense Pd	113.46 mW	Resistor	LED Current Rsns Power Dissipation
49.	BOM Count	37	System	Total Design BOM count
			Information	
50.	Cross Freq	8.705 kHz	System	Bode plot crossover frequency
			Information	
51.	Duty Cycle	14.045 %	System	Duty cycle
			Information	
52.	Efficiency	87.545 %	System	Steady state efficiency
			Information	
53.	FootPrint	790.0 mm ²	System	Total Foot Print Area of BOM components
			Information	
54.	Frequency	340.229 kHz	System	Switching frequency
			Information	
55.	Gain Marg	-24.287 dB	System	Bode Plot Gain Margin
			Information	
56.	Iout	2.0 A	System	Iout operating point
			Information	
57.	Low Freq Gain	70.444 dB	System	Gain at 1Hz
			Information	
58.	Mode	CCM	System	Conduction Mode
			Information	
59.	Operating Topology	Buck	System	The current operating topology of the device
			Information	
60.	Phase Marg	77.166 deg	System	Bode Plot Phase Margin
			Information	
61.	Pout	10.0 W	System	Total output power
			Information	
62.	SW Ipk	0.0 A	System	Peak switch current
			Information	
63.	Total BOM	\$6.64	System	Total BOM Cost
			Information	
64.	Vin	36.0 V	System	Vin operating point
			Information	
65.	Vout	5.0 V	System	Operational Output Voltage
			Information	
66.	Vout Actual	5.0 V	System	Vout Actual calculated based on selected voltage divider resistors
			Information	
67.	Vout Tolerance	1.697 %	System	Vout Tolerance based on IC Tolerance (no load) and voltage divider resistors if applicable
			Information	

#	Name	Value	Category	Description
68.	Vout p-p	24.612 mV	System Information	Peak-to-peak output ripple voltage

Design Inputs

Name	Value	Description
Iout	2.0	Maximum Output Current
VinMax	36.0	Maximum input voltage
VinMin	6.0	Minimum input voltage
Vout	5.0	Output Voltage
base_pn	LM5176	Base Product Number
source	DC	Input Source Type
Ta	30.0	Ambient temperature

WEBENCH® Assembly

Component Testing

Some published data on components in datasheets such as Capacitor ESR and Inductor DC resistance is based on conservative values that will guarantee that the components always exceed the specification. For design purposes it is usually better to work with typical values. Since this data is not always available it is a good practice to measure the Capacitance and ESR values of C_{in} and C_{out} , and the inductance and DC resistance of L1 before assembly of the board. Any large discrepancies in values should be electrically simulated in WEBENCH to check for instabilities and thermally simulated in WebTHERM to make sure critical temperatures are not exceeded.

Soldering Component to Board

If board assembly is done in house it is best to tack down one terminal of a component on the board then solder the other terminal. For surface mount parts with large tabs, such as the DPAK, the tab on the back of the package should be pre-tinned with solder, then tacked into place by one of the pins. To solder the tab down to the board place the iron down on the board while resting against the tab, heating both surfaces simultaneously. Apply light pressure to the top of the plastic case until the solder flows around the part and the part is flush with the PCB. If the solder is not flowing around the board you may need a higher wattage iron (generally 25W to 30W is enough).

Initial Startup of Circuit

It is best to initially power up the board by setting the input supply voltage to the lowest operating input voltage 6.0V and set the input supply's current limit to zero. With the input supply off connect up the input supply to V_{in} and GND. Connect a digital volt meter and a load if needed to set the minimum load of the design from V_{out} and GND. Turn on the input supply and slowly turn up the current limit on the input supply. If the voltage starts to rise on the input supply continue increasing the input supply current limit while watching the output voltage. If the current increases on the input supply, but the voltage remains near zero, then there may be a short or a component misplaced on the board. Power down the board and visually inspect for solder bridges and recheck the diode and capacitor polarities. Once the power supply circuit is operational then more extensive testing may include full load testing, transient load and line tests to compare with simulation results.

Load Testing

The setup is the same as the initial startup, except that an additional digital voltmeter is connected between V_{in} and GND, a load is connected between V_{out} and GND and a current meter is connected in series between V_{out} and the load. The load must be able to handle at least rated output power + 50% (7.5 watts for this design). Ideally the load is supplied in the form of a variable load test unit. It can also be done in the form of suitably large power resistors. When using an oscilloscope to measure waveforms on the prototype board, the ground leads of the oscilloscope probes should be as short as possible and the area of the loop formed by the ground lead should be kept to a minimum. This will help reduce ground lead inductance and eliminate EMI noise that is not actually present in the circuit.

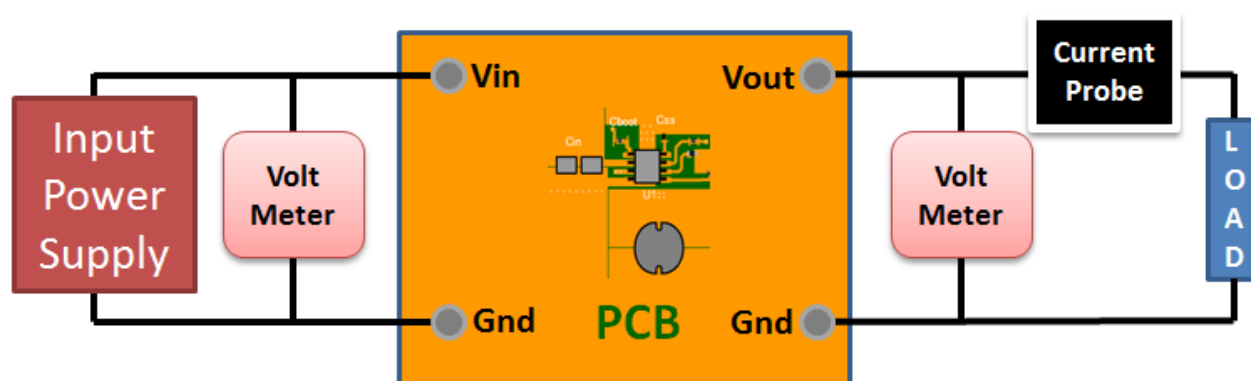

Design Assistance

1. Tip: Snubbers and/or gate resistors may be required to limit the SW1,2 node switching spikes below the IC and FET abs max ratings.
2. Tip: Slope Capacitor: smaller slope capacitors provide better transition region behavior.
3. Master key : 28F96D15EB30B202[v1]
4. **LM5176** Product Folder : <http://www.ti.com/product/LM5176> : contains the data sheet and other resources.

Important Notice and Disclaimer

TI provides technical and reliability data (including datasheets), design resources (including reference designs), application or other design advice, web tools, safety information, and other resources AS IS and with all faults, and disclaims all warranties. These resources are intended for skilled developers designing with TI products. You are solely responsible for (1) selecting the appropriate TI products for your application, (2) designing, validating and testing your application, and (3) ensuring your application meets applicable standards, and any other safety, security, or other requirements.

These resources are subject to change without notice. TI grants you permission to use these resources only for development of an application that uses the TI products described in the resource. Other reproduction and display of these resources is prohibited. No license is granted to any other TI intellectual property right or to any third party intellectual property right. TI disclaims responsibility for, and you will fully indemnify TI and its representatives against, any claims, damages, costs, losses, and liabilities arising out of your use of these resources.

Providing these resources does not expand or otherwise alter TI's applicable Terms of Sale or other applicable terms available either on ti.com or provided in conjunction with TI products.