

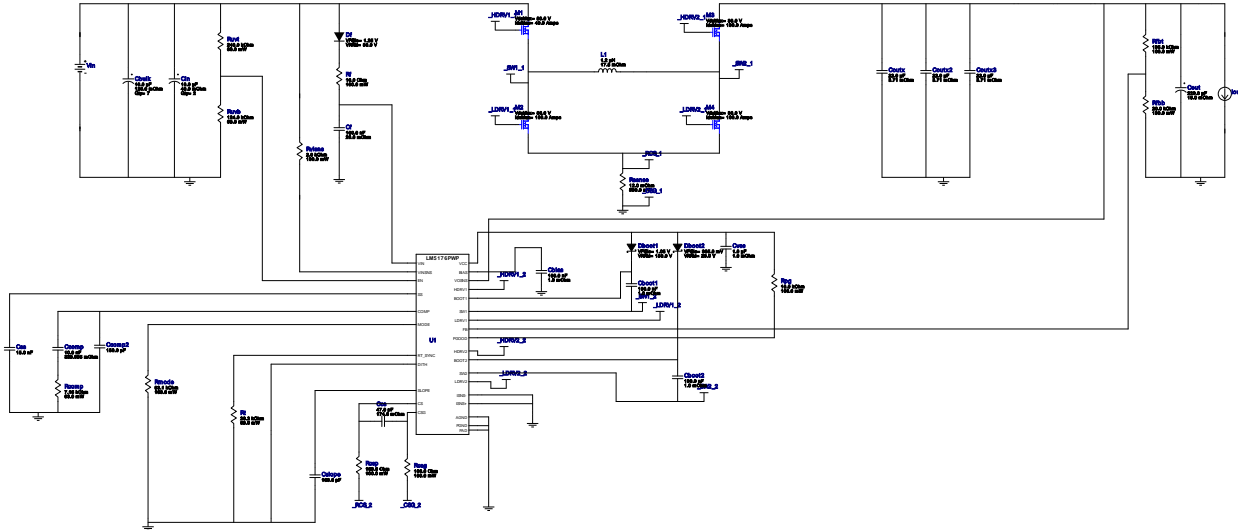

















WEBENCH® Design Report

 Design : 46 LM5176PWPR
 LM5176PWPR 4.2V-36V to 5.00V @ 5A

Electrical BOM

Name	Manufacturer	Part Number	Properties	Qty	Price	Footprint
Cbias	MuRata	GRM155R71A104KA01D Series= X7R	Cap= 100.0 nF ESR= 1.0 mOhm VDC= 10.0 V IRMS= 0.0 A	1	\$0.01	0402 3 mm ²
Cboot1	Kemet	C0603C104Z3VACTU Series= Y5V	Cap= 100.0 nF ESR= 1.0 mOhm VDC= 25.0 V IRMS= 0.0 A	1	\$0.01	0603 5 mm ²
Cboot2	Kemet	C0603C104Z3VACTU Series= Y5V	Cap= 100.0 nF ESR= 1.0 mOhm VDC= 25.0 V IRMS= 0.0 A	1	\$0.01	0603 5 mm ²
Cbulk	United Chemi-Con	HHXD630ARA100MF61G Series= SXV	Cap= 10.0 uF ESR= 120.0 mOhm VDC= 63.0 V IRMS= 2.95 A	7	\$0.19	 CAPSMT_62_E12 44 mm ²
Ccomp	TDK	CGA2B3X7R1H103K050BB Series= X7R	Cap= 10.0 nF ESR= 333.065 mOhm VDC= 50.0 V IRMS= 323.37 mA	1	\$0.01	0402 3 mm ²
Ccomp2	Samsung Electro-Mechanics	CL21C151JBANNNC Series= C0G/NP0	Cap= 150.0 pF VDC= 50.0 V IRMS= 0.0 A	1	\$0.01	0805 7 mm ²
Ccs	AVX	06035A470JAT2A Series= C0G/NP0	Cap= 47.0 pF ESR= 174.0 mOhm VDC= 50.0 V IRMS= 0.0 A	1	\$0.01	0603 5 mm ²
Cf	TDK	CGA3E2X7R1H104K080AA Series= X7R	Cap= 100.0 nF ESR= 29.6 mOhm VDC= 50.0 V IRMS= 971.99 mA	1	\$0.01	0603 5 mm ²

Name	Manufacturer	Part Number	Properties	Qty	Price	Footprint
Cin	Panasonic	50SVPF10M Series= SVPF	Cap= 10.0 uF ESR= 40.0 mOhm VDC= 50.0 V IRMS= 2.5 A	2	\$0.41	 CAPSMT_62_F61 74 mm ²
Cout	Panasonic	6SVPE220MW Series= SVPE	Cap= 220.0 uF ESR= 15.0 mOhm VDC= 6.3 V IRMS= 3.15 A	1	\$0.20	 CAPSMT_62_E61 53 mm ²
Coutx	TDK	C1608X5R1A226M080AC Series= X5R	Cap= 22.0 uF ESR= 3.71 mOhm VDC= 10.0 V IRMS= 2.69936 A	1	\$0.12	 0603 5 mm ²
Coutx2	TDK	C1608X5R1A226M080AC Series= X5R	Cap= 22.0 uF ESR= 3.71 mOhm VDC= 10.0 V IRMS= 2.69936 A	1	\$0.12	 0603 5 mm ²
Coutx3	TDK	C1608X5R1A226M080AC Series= X5R	Cap= 22.0 uF ESR= 3.71 mOhm VDC= 10.0 V IRMS= 2.69936 A	1	\$0.12	 0603 5 mm ²
Cslope	Samsung Electro-Mechanics	CL10C101JB8NNNC Series= C0G/NP0	Cap= 100.0 pF VDC= 50.0 V IRMS= 0.0 A	1	\$0.01	 0603 5 mm ²
Css	Kemet	C0603C153J3GACTU Series= C0G/NP0	Cap= 15.0 nF VDC= 25.0 V IRMS= 0.0 A	1	\$0.10	 0603 5 mm ²
Cvcc	Taiyo Yuden	EMK107B7105KA-T Series= X7R	Cap= 1.0 uF ESR= 1.0 mOhm VDC= 16.0 V IRMS= 0.0 A	1	\$0.02	 0603 5 mm ²
Dboot1	SMC Diode Solutions	SB20150TR	VF@Io= 1.05 V VRRM= 150.0 V	1	\$0.20	 DO-201AD 166 mm ²
Dboot2	Comchip Technology	CDBK0520L-HF	VF@Io= 385.0 mV VRRM= 20.0 V	1	\$0.07	 SOD-123F 12 mm ²
Df	Infineon Technologies	BAS1602VH6327XTSA1	VF@Io= 1.25 V VRRM= 80.0 V	1	\$0.04	 SOD-523 5 mm ²
L1	Coilcraft	XAL5020-122MEB	L= 1.2 uH 17.8 mOhm	1	\$0.60	 XAL5020 54 mm ²
M1	Infineon Technologies	BSC117N08NS5ATMA1	VdsMax= 80.0 V IdsMax= 49.0 Amps	1	\$0.52	 PG-TDSON-8 55 mm ²
M2	Infineon Technologies	BSC037N08NS5ATMA1	VdsMax= 80.0 V IdsMax= 100.0 Amps	1	\$1.06	 PG-TDSON-8 55 mm ²
M3	Texas Instruments	CSD17303Q5	VdsMax= 30.0 V IdsMax= 100.0 Amps	1	\$0.56	 TRANS_NexFET_Q5 55 mm ²
M4	Texas Instruments	CSD17573Q5B	VdsMax= 30.0 V IdsMax= 100.0 Amps	1	\$0.52	 DNK0008A 56 mm ²
Rcomp	Vishay-Dale	CRCW04027K15FKED Series= CRCW..e3	Res= 7.15 kOhm Power= 63.0 mW Tolerance= 1.0%	1	\$0.01	 0402 3 mm ²
Rcsg	Vishay-Dale	CRCW0603100RFKEA Series= CRCW..e3	Res= 100.0 Ohm Power= 100.0 mW Tolerance= 1.0%	1	\$0.01	 0603 5 mm ²

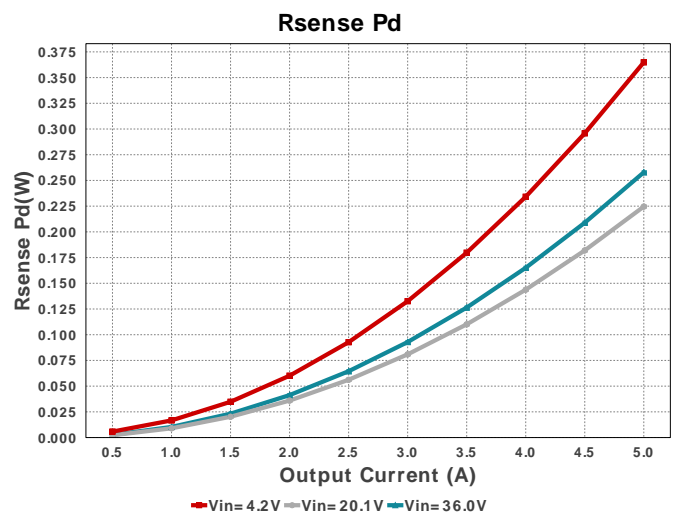
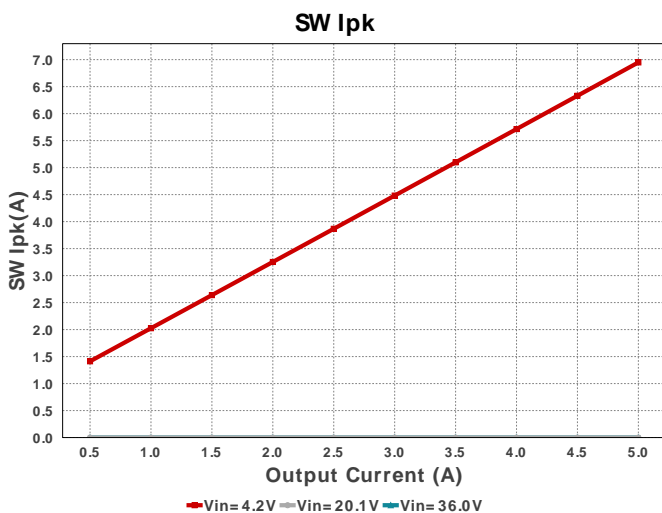
Name	Manufacturer	Part Number	Properties	Qty	Price	Footprint
Rcsp	Vishay-Dale	CRCW0603100RFKEA Series= CRCW..e3	Res= 100.0 Ohm Power= 100.0 mW Tolerance= 1.0%	1	\$0.01	0603 5 mm ²
Rf	Vishay-Dale	CRCW060310R0FKEA Series= CRCW..e3	Res= 10.0 Ohm Power= 100.0 mW Tolerance= 1.0%	1	\$0.01	0603 5 mm ²
Rfbb	Vishay-Dale	CRCW060320K0FKEA Series= CRCW..e3	Res= 20.0 kOhm Power= 100.0 mW Tolerance= 1.0%	1	\$0.01	0603 5 mm ²
Rfbt	Vishay-Dale	CRCW0603105KFKEA Series= CRCW..e3	Res= 105.0 kOhm Power= 100.0 mW Tolerance= 1.0%	1	\$0.01	0603 5 mm ²
Rmode	Vishay-Dale	CRCW060393K1FKEA Series= CRCW..e3	Res= 93.1 kOhm Power= 100.0 mW Tolerance= 1.0%	1	\$0.01	0603 5 mm ²
Rpg	Vishay-Dale	CRCW060310K0FKEA Series= CRCW..e3	Res= 10.0 kOhm Power= 100.0 mW Tolerance= 1.0%	1	\$0.01	0603 5 mm ²
Rsense	Stackpole Electronics Inc	CSR1206FK12L0 Series= ?	Res= 12.0 mOhm Power= 500.0 mW Tolerance= 1.0%	1	\$0.12	1206 11 mm ²
Rt	Vishay-Dale	CRCW040223K2FKED Series= CRCW..e3	Res= 23.2 kOhm Power= 63.0 mW Tolerance= 1.0%	1	\$0.01	0402 3 mm ²
Ruvb	Vishay-Dale	CRCW0402124KFKEA Series= CRCW..e3	Res= 124.0 kOhm Power= 63.0 mW Tolerance= 1.0%	1	\$0.01	0402 3 mm ²
Ruvt	Vishay-Dale	CRCW0402249KFKEA Series= CRCW..e3	Res= 249.0 kOhm Power= 63.0 mW Tolerance= 1.0%	1	\$0.01	0402 3 mm ²
Rvisns	Vishay-Dale	CRCW06032K00FKEA Series= CRCW..e3	Res= 2.0 kOhm Power= 100.0 mW Tolerance= 1.0%	1	\$0.01	0603 5 mm ²
U1	Texas Instruments	LM5176PWPR	Switcher	1	\$2.64	PWP0028C_N 98 mm ²

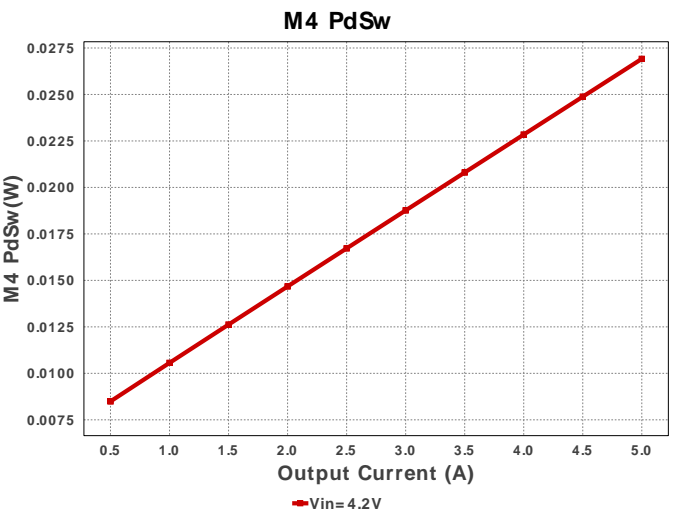
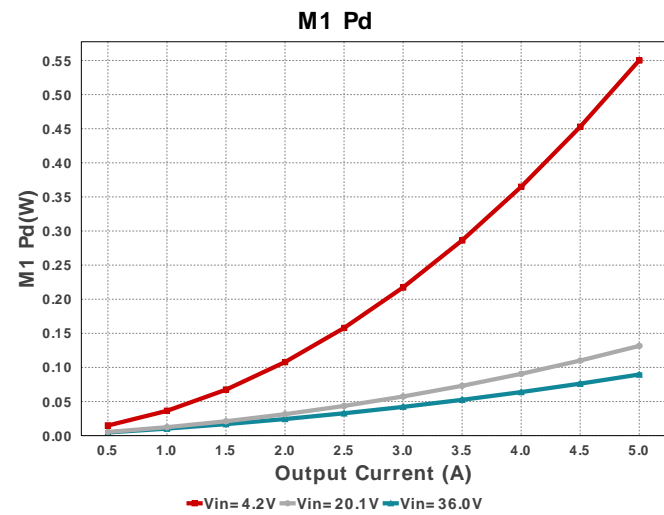
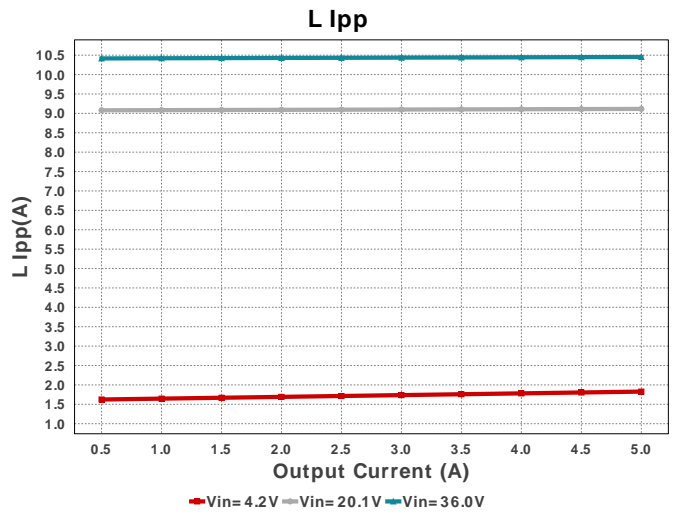
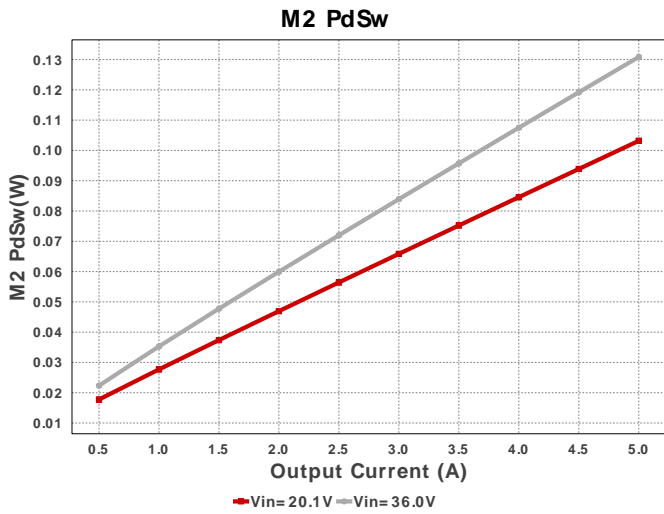
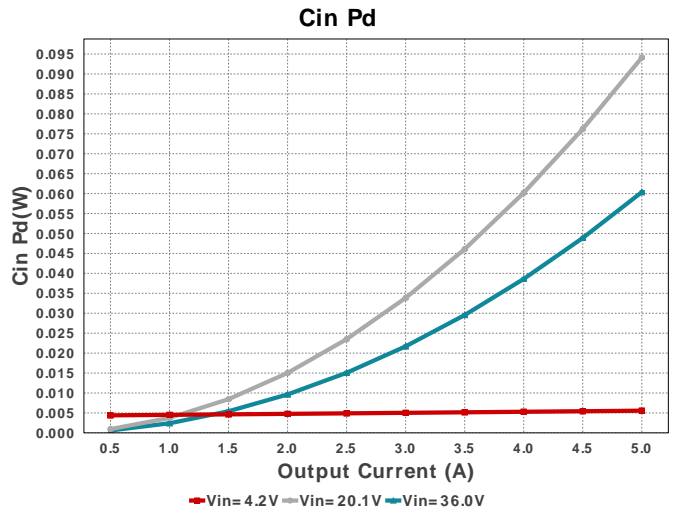
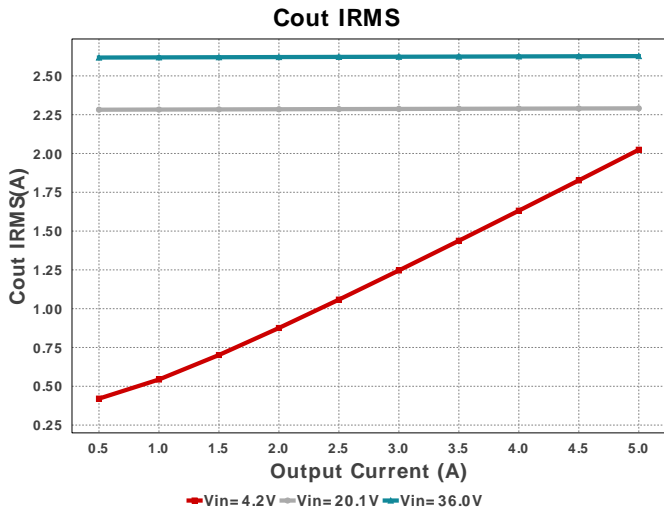



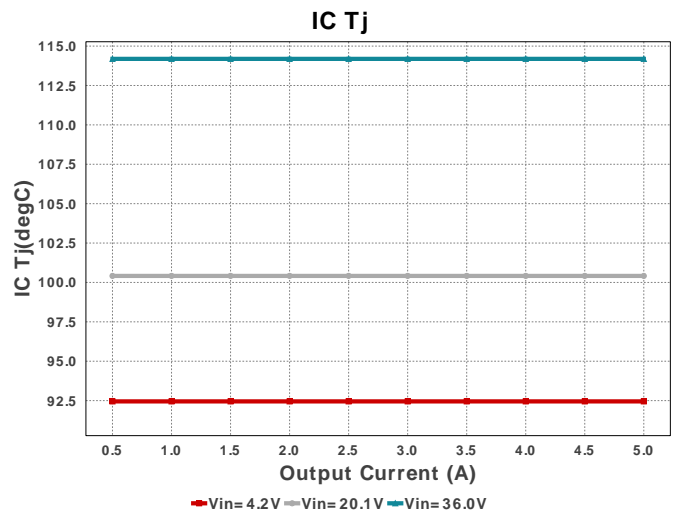
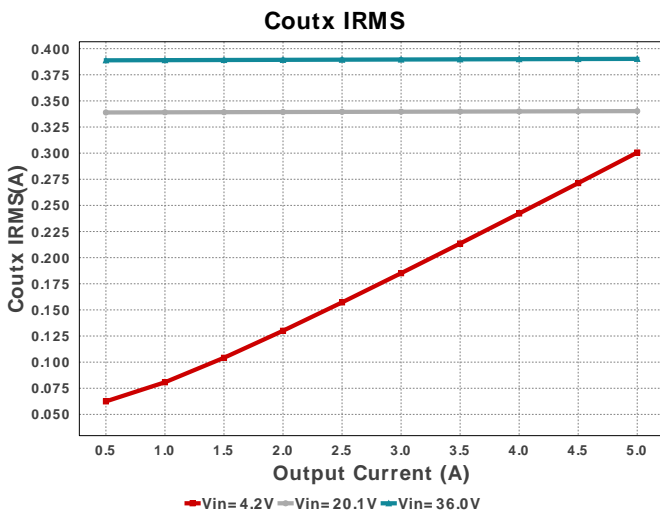
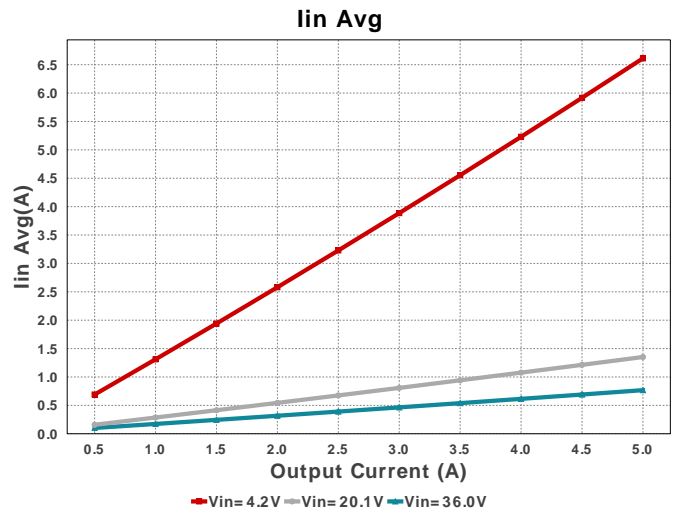
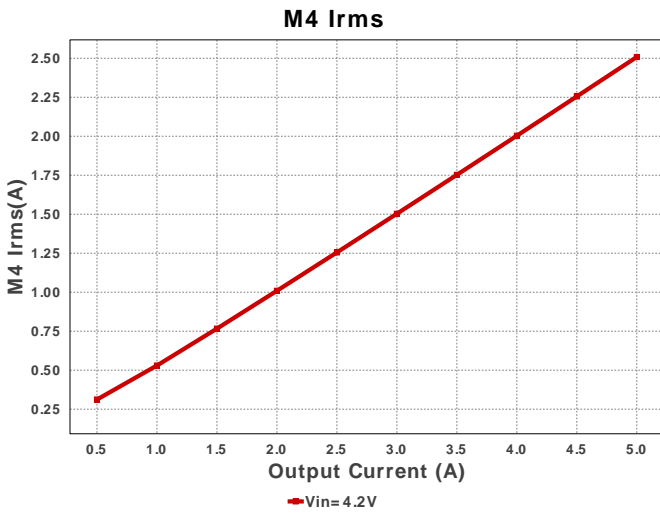
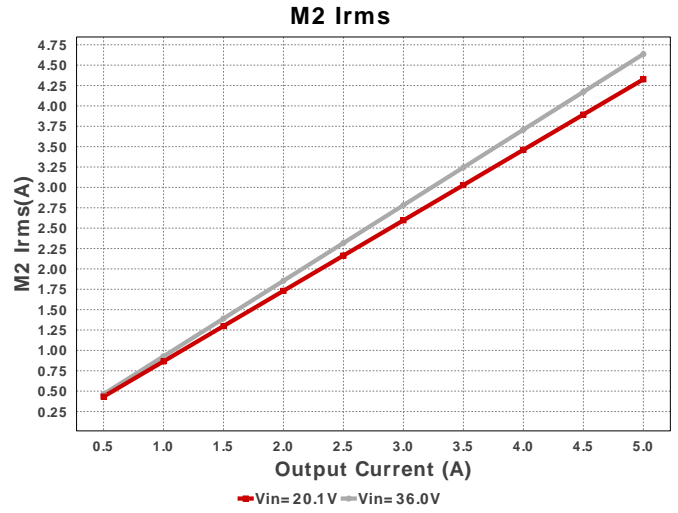
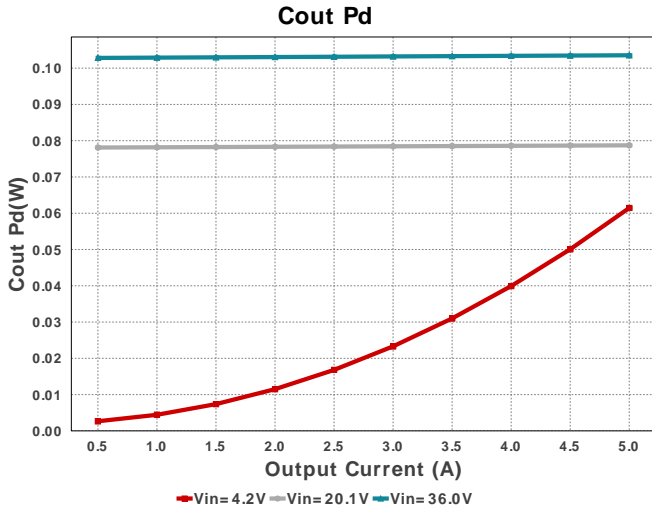

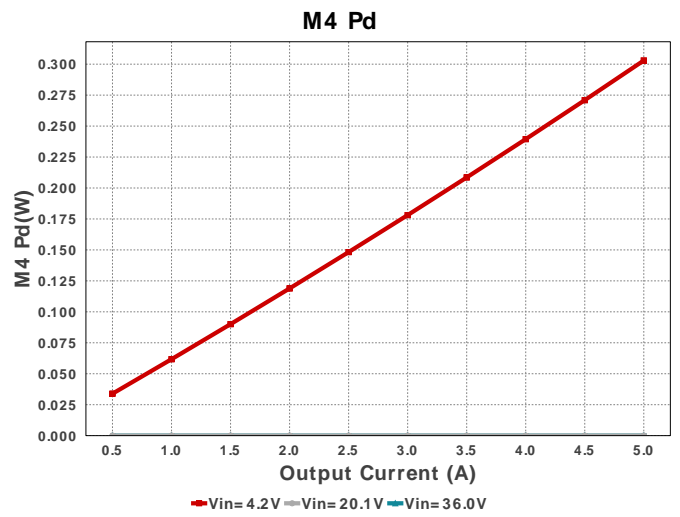
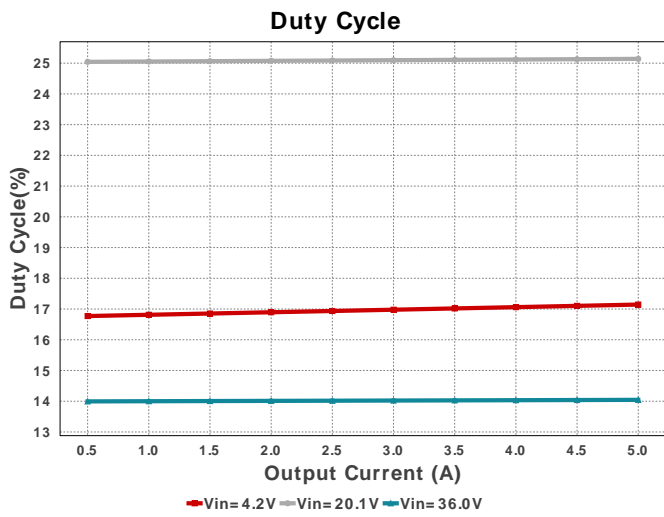
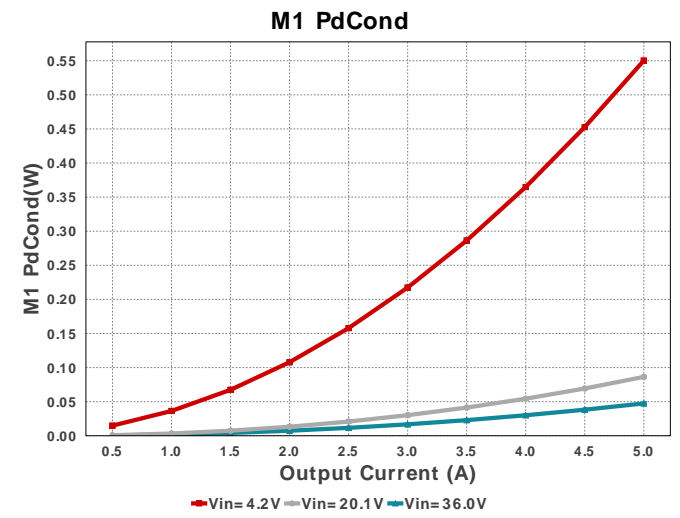
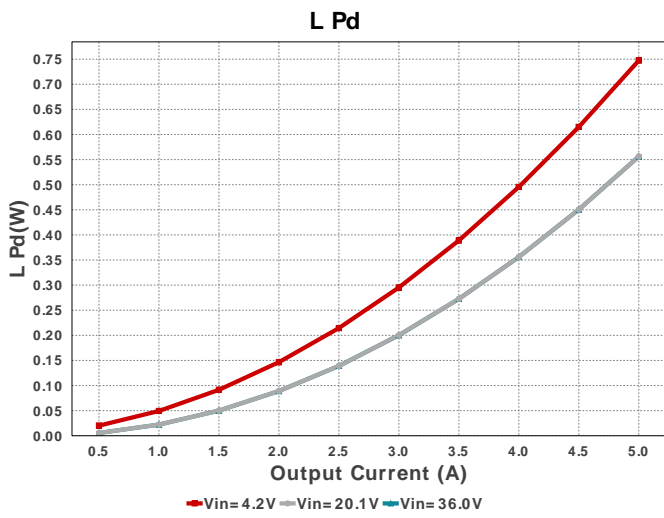
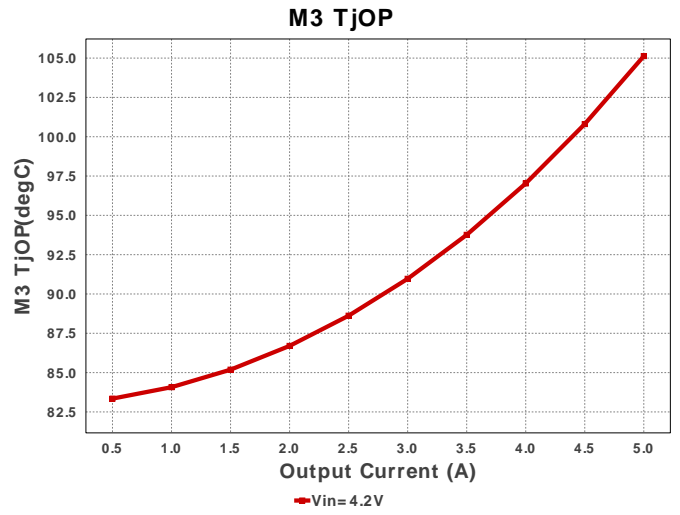
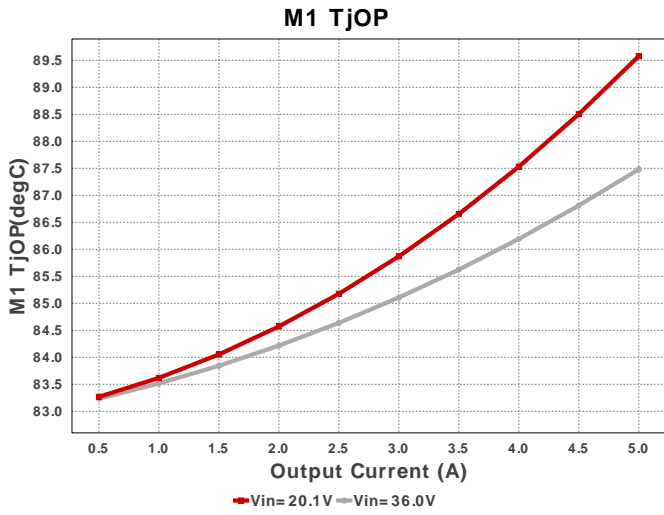

M2 PdCond

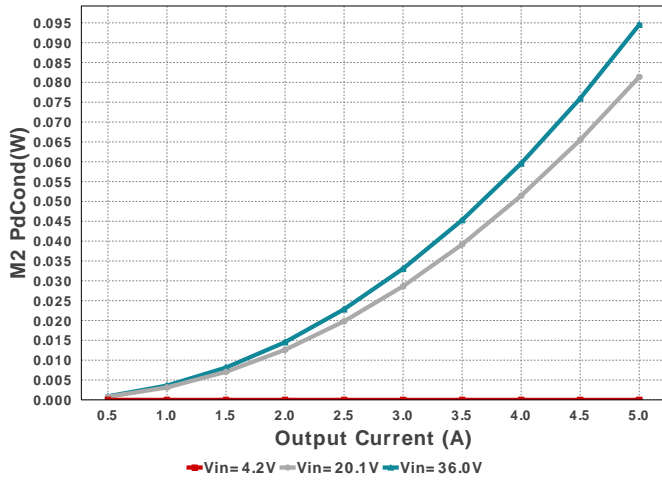

M3 PdCond

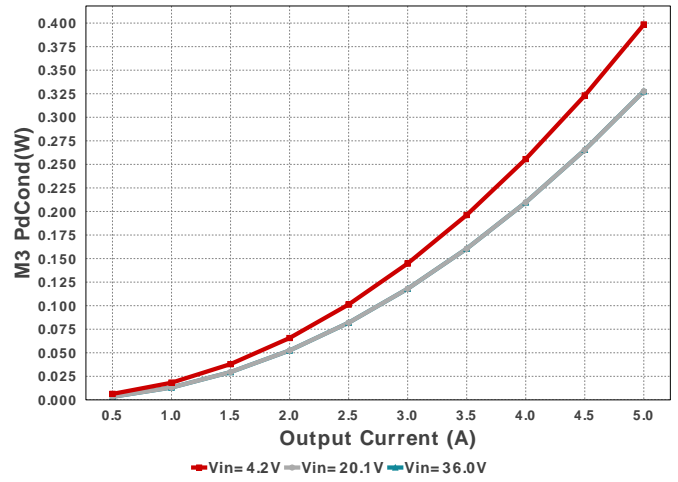

Efficiency

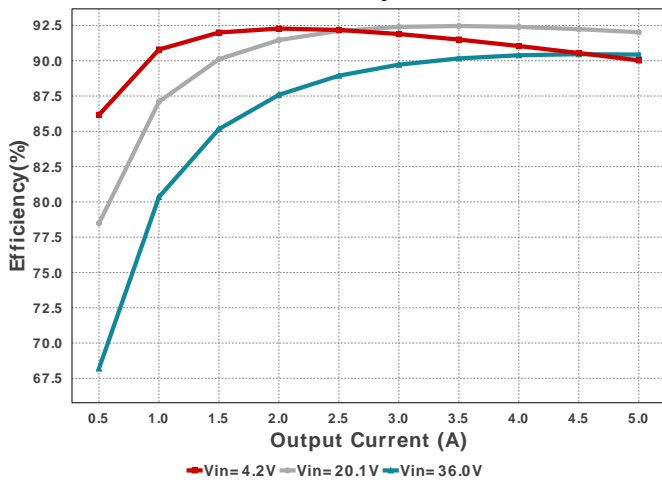

Coutx Pd

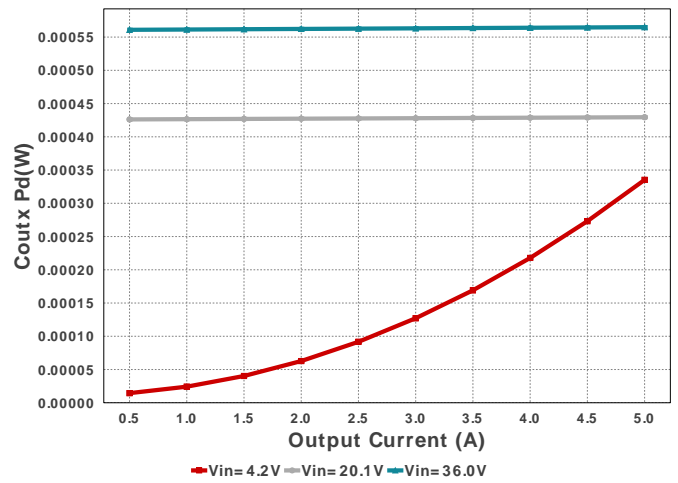

M4 PdCond

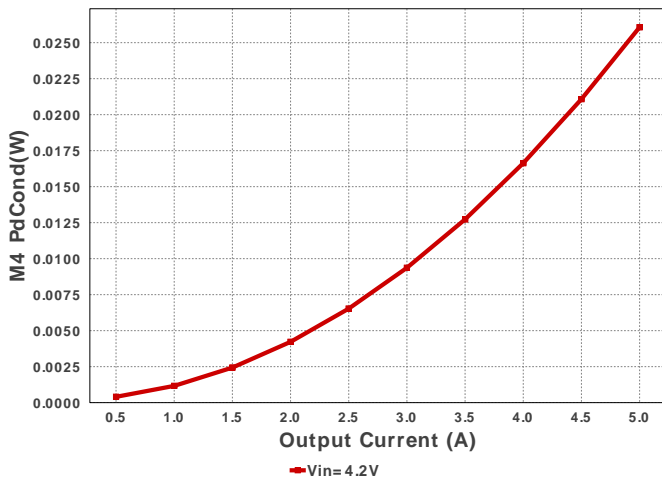

M2 Pd

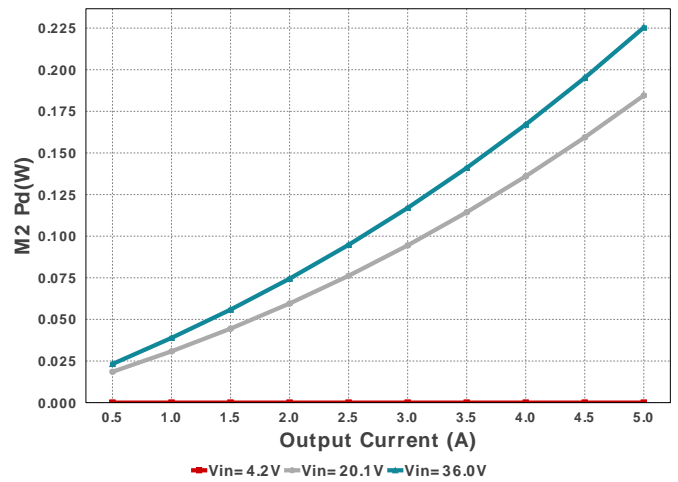

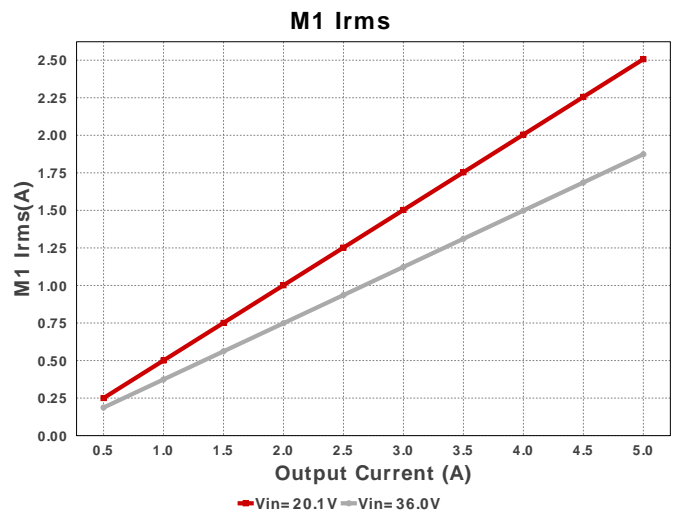
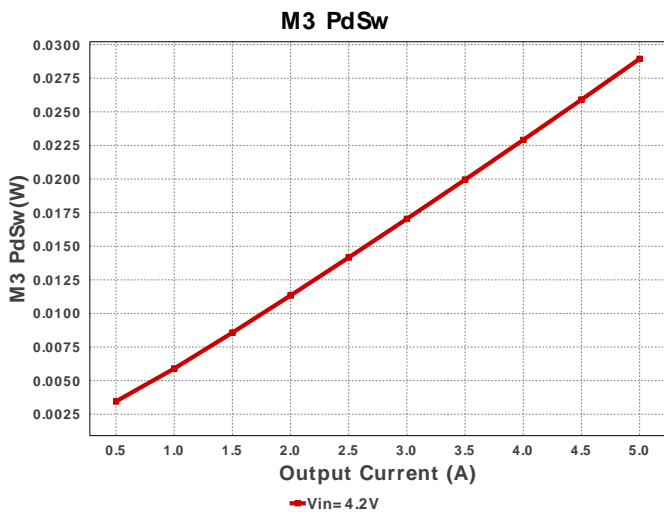
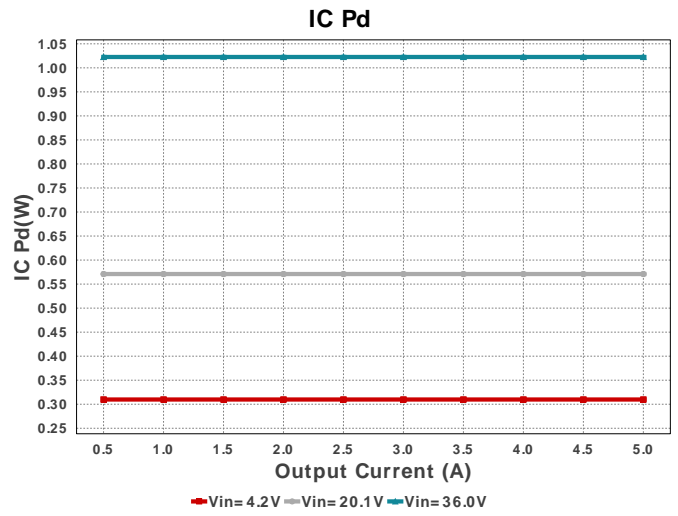
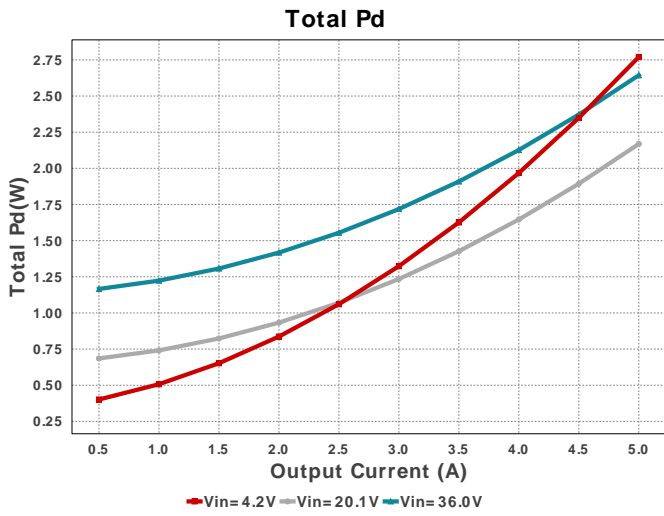
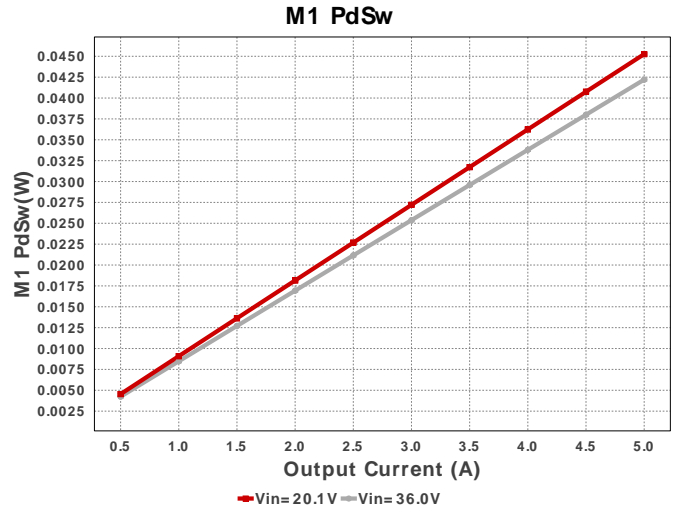
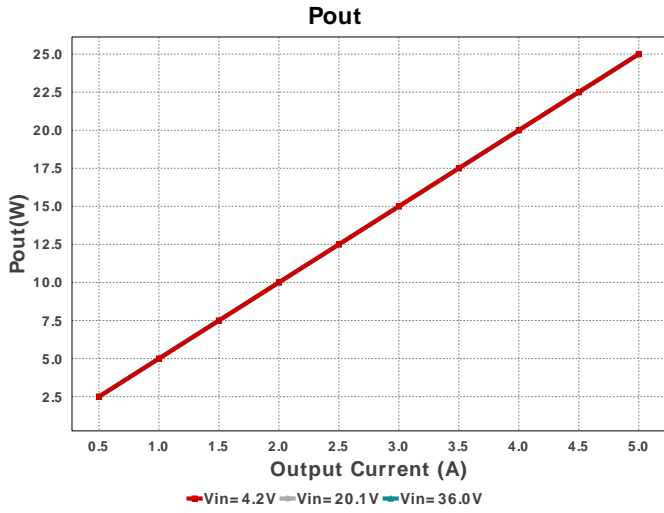

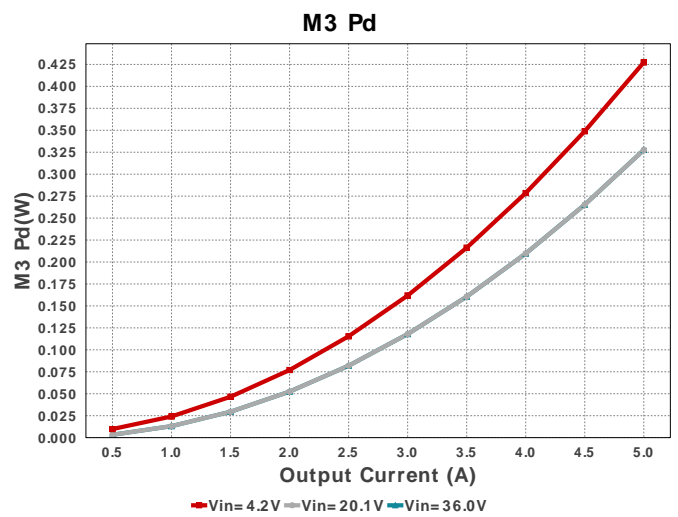
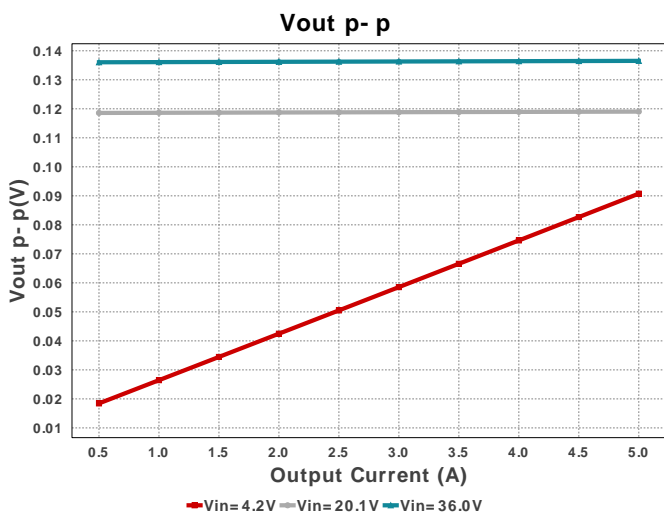
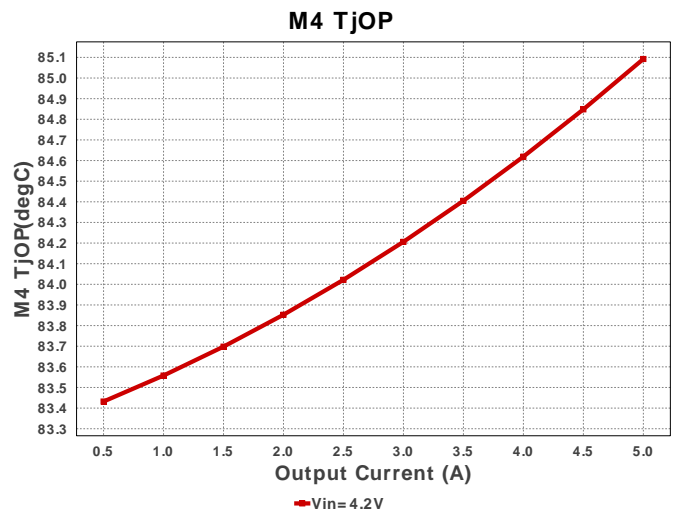
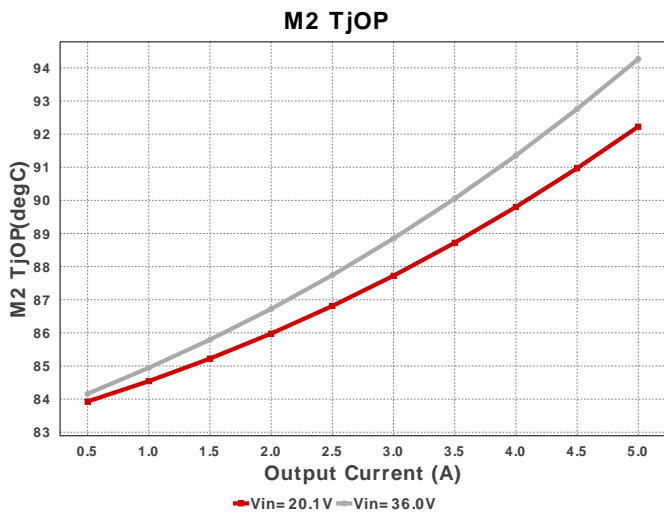
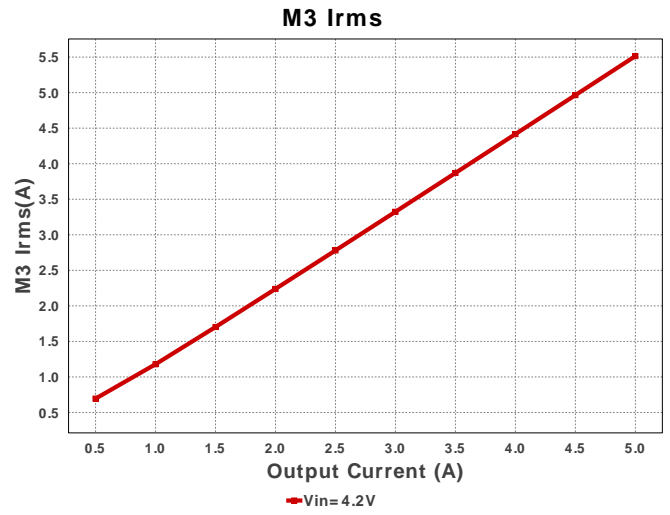
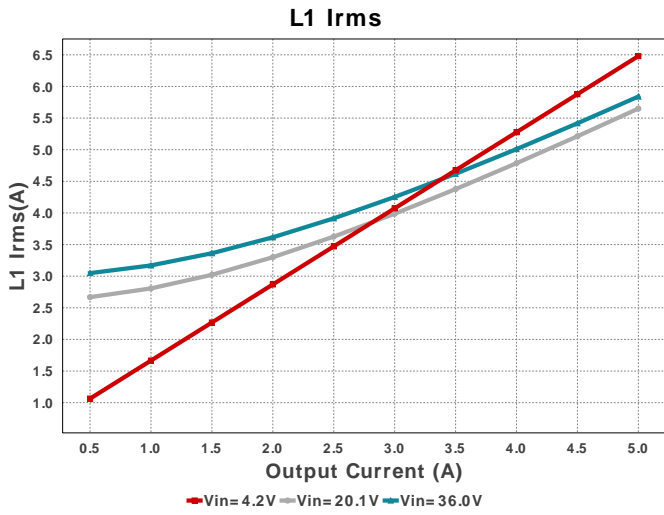

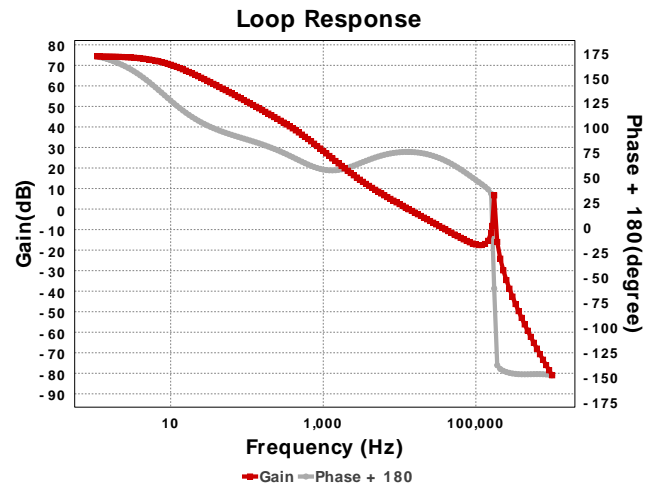
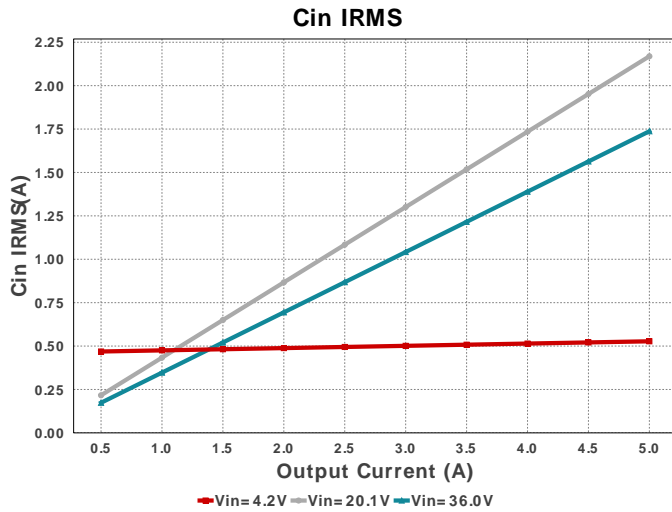

Operating Values

#	Name	Value	Category	Description
1.	BOM Count	45		Total Design BOM count
2.	Total BOM	\$9.363		Total BOM Cost
3.	Cin IRMS	1.737 A	Capacitor	Input capacitor RMS ripple current
4.	Cin Pd	60.36 mW	Capacitor	Input capacitor power dissipation
5.	Cout IRMS	2.627 A	Capacitor	Output capacitor RMS ripple current
6.	Cout Pd	103.55 mW	Capacitor	Output capacitor power dissipation
7.	Coutx IRMS	390.221 mA	Capacitor	Output capacitor_x RMS ripple current
8.	Coutx Pd	564.93 μW	Capacitor	Output capacitor_x power loss
9.	IC Pd	1.023 W	IC	IC power dissipation
10.	IC Tj	114.19 degC	IC	IC junction temperature
11.	IC Tolerance	0.0 V	IC	IC Feedback Tolerance
12.	ICThetaJA	30.5 degC/W	IC	IC junction-to-ambient thermal resistance
13.	Iin Avg	769.09 mA	IC	Average input current
14.	L Ipp	10.454 A	Inductor	Peak-to-peak inductor ripple current
15.	L Pd	556.25 mW	Inductor	Inductor power dissipation
16.	L1 Irms	5.84 A	Inductor	Inductor ripple current
17.	M1 Irms	1.874 A	Mosfet	MOSFET RMS ripple current
18.	M1 Pd	195.15 mW	Mosfet	MOSFET power dissipation
19.	M1 PdCond	50.78 mW	Mosfet	M1 MOSFET conduction losses
20.	M1 PdSw	144.37 mW	Mosfet	M1 MOSFET switching losses
21.	M1 Rdson	13.104 mOhm	Mosfet	Drain-Source On-resistance
22.	M1 ThetaJA	50.0 degC/W	Mosfet	MOSFET junction-to-ambient thermal resistance
23.	M1 TjOP	92.757 degC	Mosfet	MOSFET junction temperature
24.	M2 Irms	4.636 A	Mosfet	MOSFET RMS ripple current
25.	M2 Pd	163.46 mW	Mosfet	MOSFET power dissipation
26.	M2 PdCond	91.91 mW	Mosfet	M2 MOSFET conduction losses
27.	M2 PdSw	71.546 mW	Mosfet	M2 MOSFET switching losses
28.	M2 Rdson	4.144 mOhm	Mosfet	Drain-Source On-resistance
29.	M2 ThetaJA	50.0 degC/W	Mosfet	MOSFET junction-to-ambient thermal resistance
30.	M2 TjOP	91.173 degC	Mosfet	MOSFET junction temperature
31.	M3 Pd	327.6 mW	Mosfet	M3 MOSFET total power dissipation
32.	M3 PdCond	327.6 mW	Mosfet	M3 MOSFET conduction losses
33.	M4 Pd	100.0 pW	Mosfet	M4 MOSFET total power dissipation
34.	Cin Pd	60.36 mW	Power	Input capacitor power dissipation
35.	Cout Pd	103.55 mW	Power	Output capacitor power dissipation
36.	Coutx Pd	564.93 μW	Power	Output capacitor_x power loss
37.	IC Pd	1.023 W	Power	IC power dissipation
38.	L Pd	556.25 mW	Power	Inductor power dissipation
39.	M1 Pd	195.15 mW	Power	MOSFET power dissipation
40.	M1 PdCond	50.78 mW	Power	M1 MOSFET conduction losses
41.	M1 PdSw	144.37 mW	Power	M1 MOSFET switching losses
42.	M2 Pd	163.46 mW	Power	MOSFET power dissipation
43.	M2 PdCond	91.91 mW	Power	M2 MOSFET conduction losses
44.	M2 PdSw	71.546 mW	Power	M2 MOSFET switching losses
45.	M3 Pd	327.6 mW	Power	M3 MOSFET total power dissipation
46.	M3 PdCond	327.6 mW	Power	M3 MOSFET conduction losses
47.	M4 Pd	100.0 pW	Power	M4 MOSFET total power dissipation
48.	Rsense Pd	257.87 mW	Power	LED Current Rsns Power Dissipation
49.	Total Pd	2.687 W	Power	Total Power Dissipation
50.	Rsense Pd	257.87 mW	Resistor	LED Current Rsns Power Dissipation
51.	Cross Freq	13.082 kHz	System Information	Bode plot crossover frequency

#	Name	Value	Category	Description
52.	Duty Cycle	14.045 %	System Information	Duty cycle
53.	Efficiency	90.294 %	System Information	Steady state efficiency
54.	FootPrint	1.621 k mm ²	System Information	Total Foot Print Area of BOM components
55.	Frequency	347.078 kHz	System Information	Switching frequency
56.	Gain Marg	-8.193 dB	System Information	Bode Plot Gain Margin
57.	Iout	5.0 A	System Information	Iout operating point
58.	Low Freq Gain	74.343 dB	System Information	Gain at 1Hz
59.	Mode	CCM	System Information	Conduction Mode
60.	Operating Topology	Buck	System Information	The current operating topology of the device
61.	Phase Marg	76.425 deg	System Information	Bode Plot Phase Margin
62.	Pout	25.0 W	System Information	Total output power
63.	SW Ipk	0.0 A	System Information	Peak switch current
64.	Vin	36.0 V	System Information	Vin operating point
65.	Vout	5.0 V	System Information	Operational Output Voltage
66.	Vout Actual	5.0 V	System Information	Vout Actual calculated based on selected voltage divider resistors
67.	Vout Tolerance	1.697 %	System Information	Vout Tolerance based on IC Tolerance (no load) and voltage divider resistors if applicable
68.	Vout p-p	136.527 mV	System Information	Peak-to-peak output ripple voltage

Design Inputs

Name	Value	Description
Iout	5.0	Maximum Output Current
VinMax	36.0	Maximum input voltage
VinMin	4.2	Minimum input voltage
Vout	5.0	Output Voltage
base_pn	LM5176	Base Product Number
source	DC	Input Source Type
Ta	83.0	Ambient temperature

WEBENCH® Assembly

Component Testing

Some published data on components in datasheets such as Capacitor ESR and Inductor DC resistance is based on conservative values that will guarantee that the components always exceed the specification. For design purposes it is usually better to work with typical values. Since this data is not always available it is a good practice to measure the Capacitance and ESR values of C_{in} and C_{out} , and the inductance and DC resistance of L1 before assembly of the board. Any large discrepancies in values should be electrically simulated in WEBENCH to check for instabilities and thermally simulated in WebTHERM to make sure critical temperatures are not exceeded.

Soldering Component to Board

If board assembly is done in house it is best to tack down one terminal of a component on the board then solder the other terminal. For surface mount parts with large tabs, such as the DPAK, the tab on the back of the package should be pre-tinned with solder, then tacked into place by one of the pins. To solder the tab down to the board place the iron down on the board while resting against the tab, heating both surfaces simultaneously. Apply light pressure to the top of the plastic case until the solder flows around the part and the part is flush with the PCB. If the solder is not flowing around the board you may need a higher wattage iron (generally 25W to 30W is enough).

Initial Startup of Circuit

It is best to initially power up the board by setting the input supply voltage to the lowest operating input voltage 4.2V and set the input supply's current limit to zero. With the input supply off connect up the input supply to V_{in} and GND. Connect a digital volt meter and a load if needed to set the minimum load of the design from V_{out} and GND. Turn on the input supply and slowly turn up the current limit on the input supply. If the voltage starts to rise on the input supply continue increasing the input supply current limit while watching the output voltage. If the current increases on the input supply, but the voltage remains near zero, then there may be a short or a component misplaced on the board. Power down the board and visually inspect for solder bridges and recheck the diode and capacitor polarities. Once the power supply circuit is operational then more extensive testing may include full load testing, transient load and line tests to compare with simulation results.

Load Testing

The setup is the same as the initial startup, except that an additional digital voltmeter is connected between V_{in} and GND, a load is connected between V_{out} and GND and a current meter is connected in series between V_{out} and the load. The load must be able to handle at least rated output power + 50% (7.5 watts for this design). Ideally the load is supplied in the form of a variable load test unit. It can also be done in the form of suitably large power resistors. When using an oscilloscope to measure waveforms on the prototype board, the ground leads of the oscilloscope probes should be as short as possible and the area of the loop formed by the ground lead should be kept to a minimum. This will help reduce ground lead inductance and eliminate EMI noise that is not actually present in the circuit.

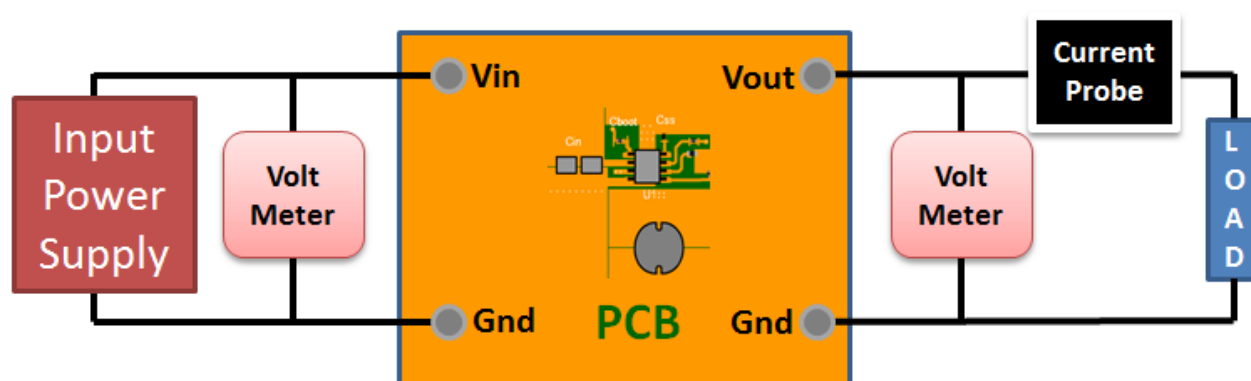

WEBENCH® Electrical Simulation Report

Design Id = 46

sim_id = 7

Simulation Type = Input Transient

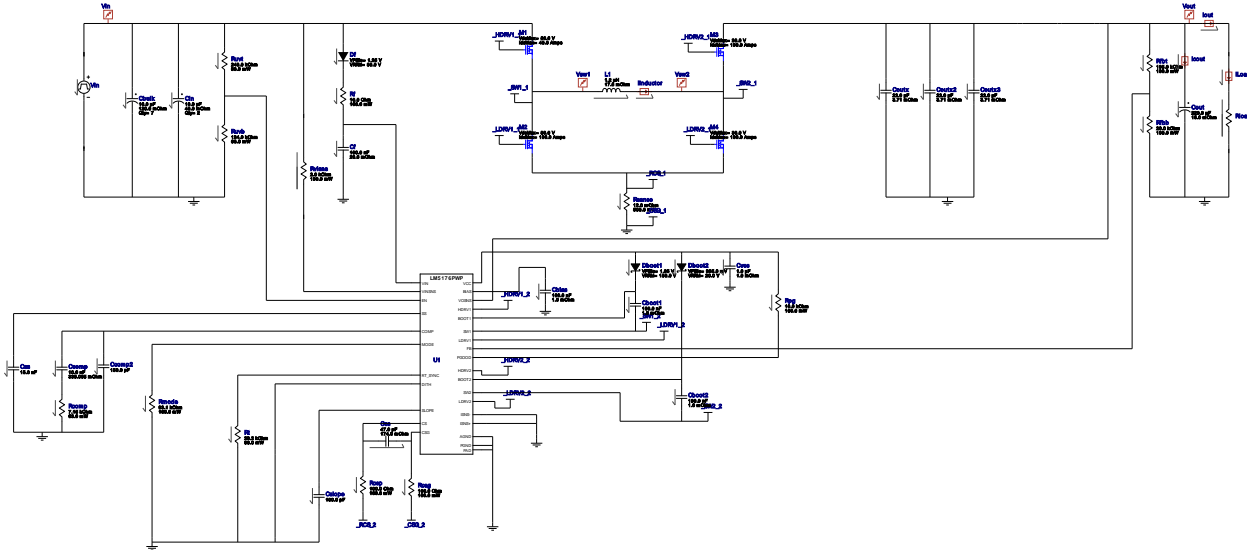

Simulation Parameters

#	Name	Parameter Name	Description	Values
1.	Cslope	IC	Initial Voltage	0 V
2.	Ccomp2	IC	Initial Voltage	2.146362569142857 V
3.	Cout	IC	Initial Voltage	5.0 V
4.	L1	IC	Initial Current	-7.002801120448179 A
5.	Rload	R	Load Resistance	1.0 Ohm

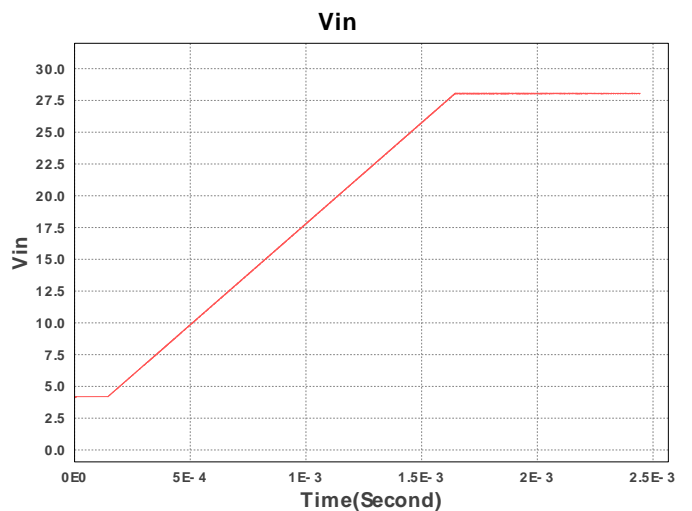
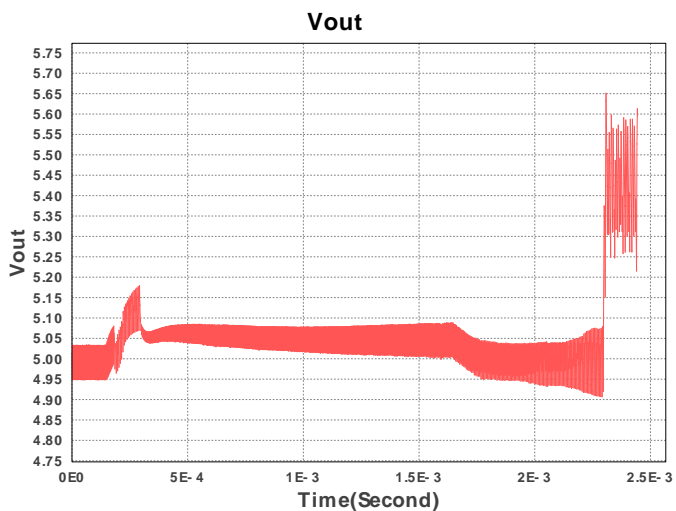

Design Assistance

1. Tip: Snubbers and/or gate resistors may be required to limit the SW1,2 node switching spikes below the IC and FET abs max ratings.
2. Tip: Slope Capacitor: smaller slope capacitors provide better transition region behavior.
3. Master key : F4DBCFEECAB1DEC5[v1]
4. **LM5176 Product Folder** : <http://www.ti.com/product/LM5176> : contains the data sheet and other resources.

Important Notice and Disclaimer

TI provides technical and reliability data (including datasheets), design resources (including reference designs), application or other design advice, web tools, safety information, and other resources AS IS and with all faults, and disclaims all warranties. These resources are intended for skilled developers designing with TI products. You are solely responsible for (1) selecting the appropriate TI products for your application, (2) designing, validating and testing your application, and (3) ensuring your application meets applicable standards, and any other safety, security, or other requirements.

These resources are subject to change without notice. TI grants you permission to use these resources only for development of an application that uses the TI products described in the resource. Other reproduction and display of these resources is prohibited. No license is granted to any other TI intellectual property right or to any third party intellectual property right. TI disclaims responsibility for, and you will fully indemnify TI and its representatives against, any claims, damages, costs, losses, and liabilities arising out of your use of these resources.

Providing these resources does not expand or otherwise alter TI's applicable Terms of Sale or other applicable terms available either on ti.com or provided in conjunction with TI products.