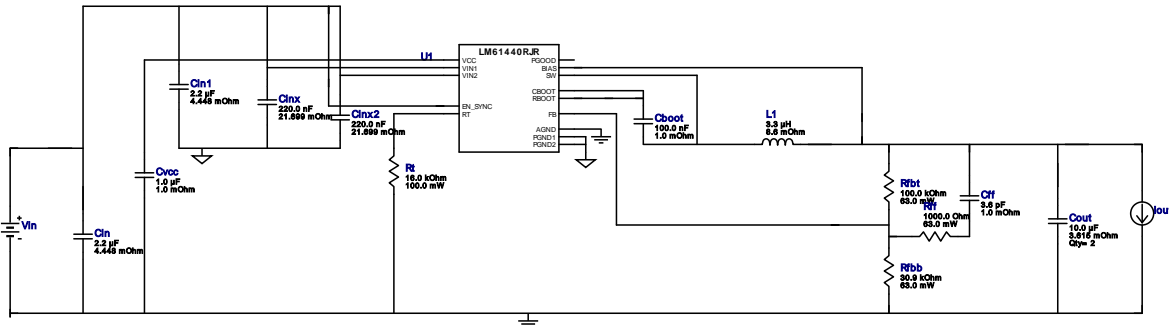

WEBENCH® Design Report

 Design : 6779 LM61440AANRJR
 LM61440AANRJR 18V-32V to 4.00V @ 4A

 Vout = 4.2V
 Iout = 2.0A

Electrical BOM

Name	Manufacturer	Part Number	Properties	Qty	Price	Footprint
Cboot	MuRata	GRM155R71A104KA01D Series= X7R	Cap= 100.0 nF ESR= 1.0 mOhm VDC= 10.0 V IRMS= 0.0 A	1	\$0.01	0402 3 mm ²
Cff	MuRata	GRM1555C1H3R6CA01D Series= C0G/NP0	Cap= 3.6 pF ESR= 1.0 mOhm VDC= 50.0 V IRMS= 0.0 A	1	\$0.01	0402 3 mm ²
Cin	MuRata	GRM31CR61H225KA88L Series= X5R	Cap= 2.2 uF ESR= 4.448 mOhm VDC= 50.0 V IRMS= 2.2252 A	1	\$0.10	1206_190 11 mm ²
Cin1	MuRata	GRM31CR61H225KA88L Series= X5R	Cap= 2.2 uF ESR= 4.448 mOhm VDC= 50.0 V IRMS= 2.2252 A	1	\$0.10	1206_190 11 mm ²
Cinx	TDK	CGA3E3X7R1H224K080AB Series= X7R	Cap= 220.0 nF ESR= 21.699 mOhm VDC= 50.0 V IRMS= 1.125 A	1	\$0.03	0603 5 mm ²
Cinx2	TDK	CGA3E3X7R1H224K080AB Series= X7R	Cap= 220.0 nF ESR= 21.699 mOhm VDC= 50.0 V IRMS= 1.125 A	1	\$0.03	0603 5 mm ²
Cout	MuRata	GRM31CR61C106KA88L Series= X5R	Cap= 10.0 uF ESR= 3.615 mOhm VDC= 16.0 V IRMS= 3.8281 A	2	\$0.08	1206_190 11 mm ²
Cvcc	Kemet	C0603C105Z8VACTU Series= Y5V	Cap= 1.0 uF ESR= 1.0 mOhm VDC= 10.0 V IRMS= 0.0 A	1	\$0.01	0603 5 mm ²
L1	Coilcraft	XAL7070-332MEB	L= 3.3 uH 8.6 mOhm	1	\$1.19	XAL7070 87 mm ²
Rfbb	Vishay-Dale	CRCW040230K9FKED Series= CRCW..e3	Res= 30.9 kOhm Power= 63.0 mW Tolerance= 1.0%	1	\$0.01	0402 3 mm ²

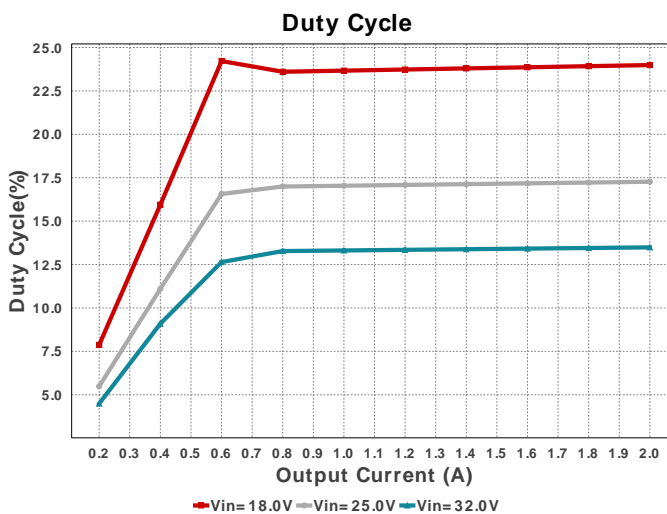
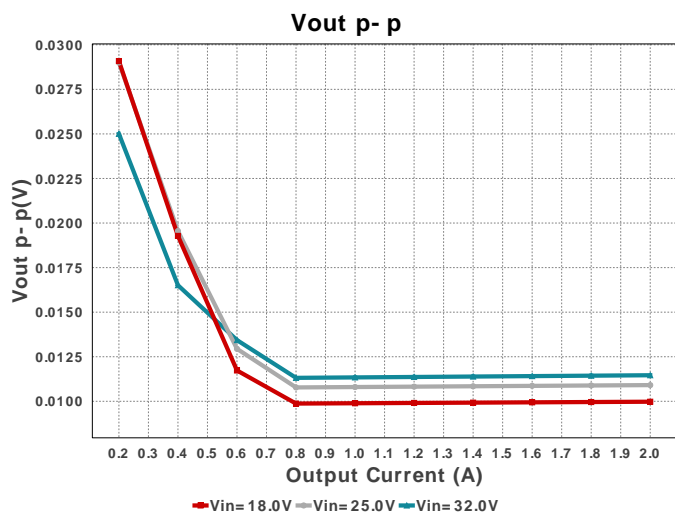
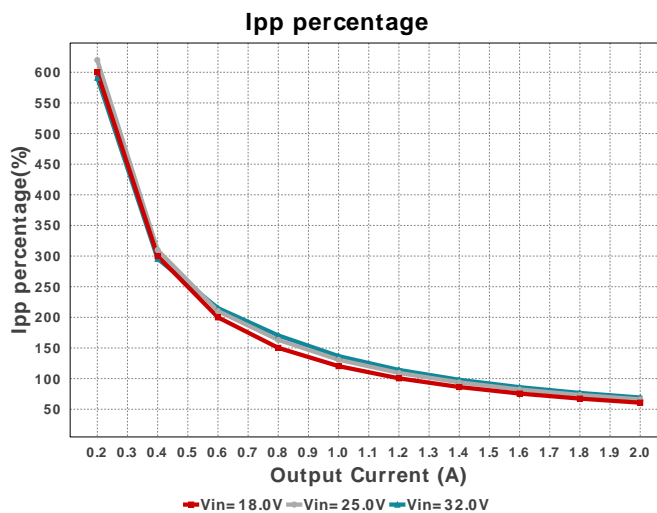
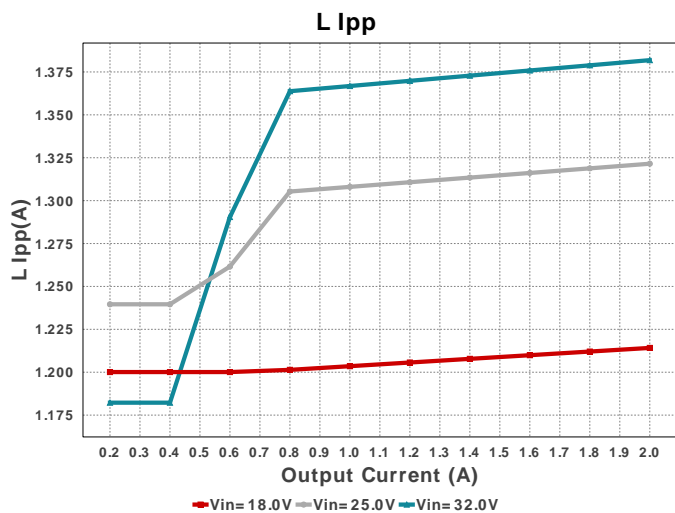
Name	Manufacturer	Part Number	Properties	Qty	Price	Footprint
Rfbt	Vishay-Dale	CRCW0402100KFKED Series= CRCW..e3	Res= 100.0 kOhm Power= 63.0 mW Tolerance= 1.0%	1	\$0.01	0402 3 mm ²
Rff	Vishay-Dale	CRCW04021K00FKED Series= CRCW..e3	Res= 1000.0 Ohm Power= 63.0 mW Tolerance= 1.0%	1	\$0.01	0402 3 mm ²
Rt	Yageo	RC0603FR-0716KL Series= ?	Res= 16.0 kOhm Power= 100.0 mW Tolerance= 1.0%	1	\$0.01	0603 5 mm ²
U1	Texas Instruments	LM61440AANRJRR	Switcher	1	\$1.35	RJR0014A 22 mm ²

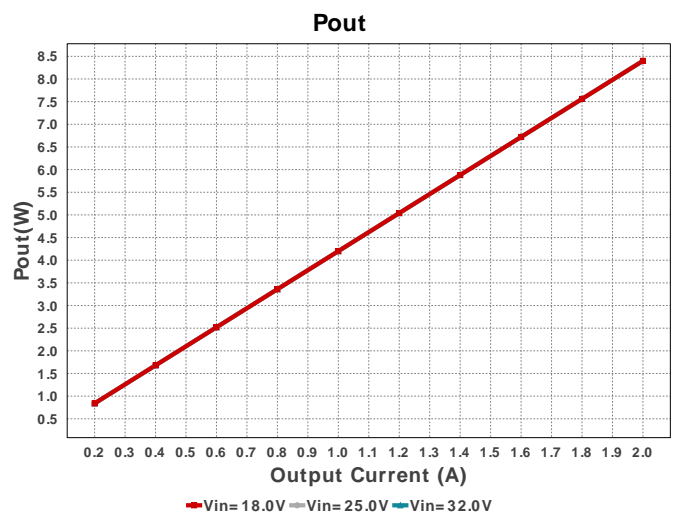
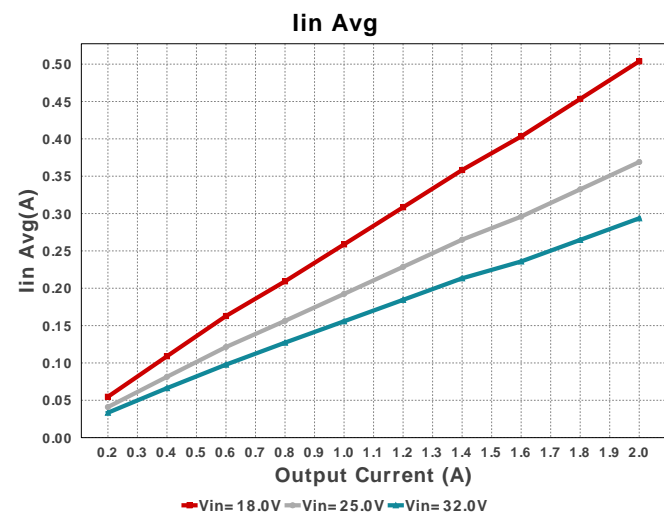
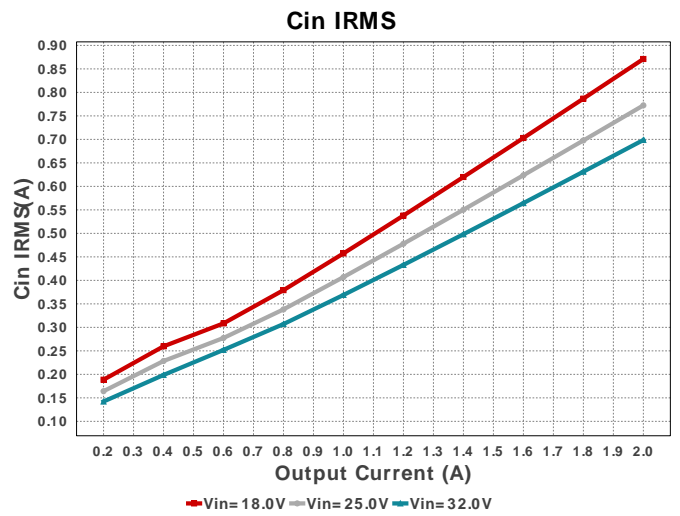
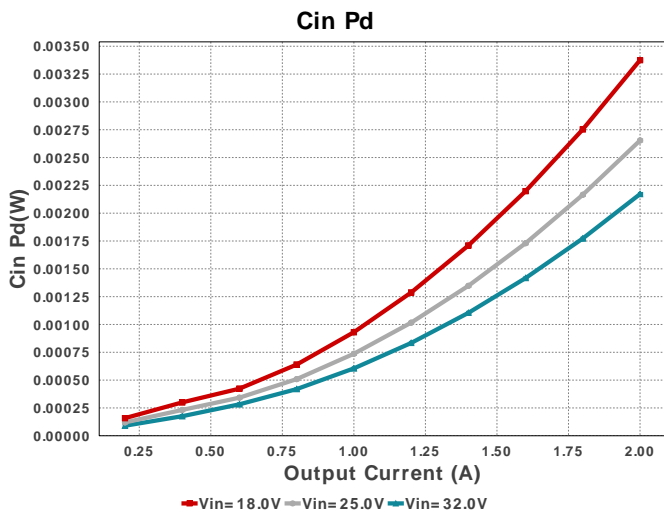
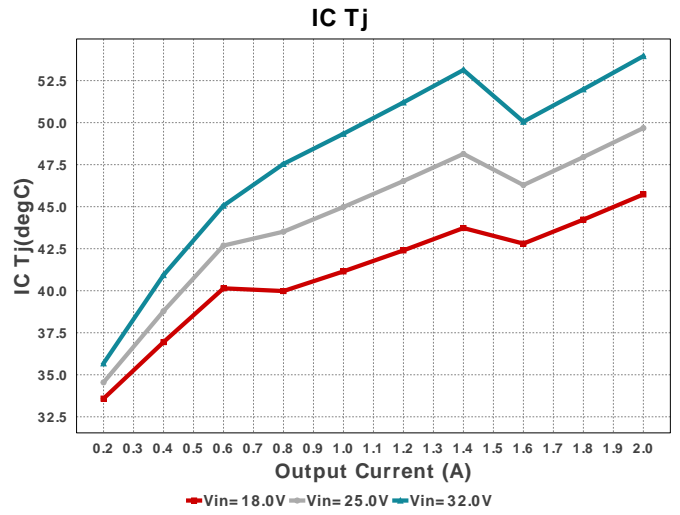
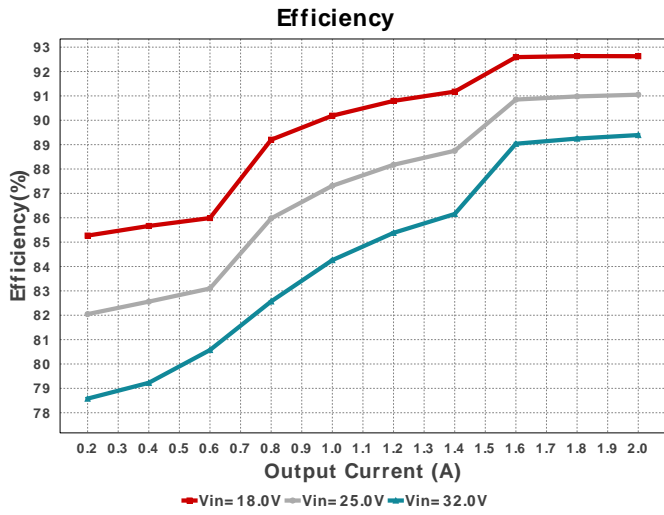

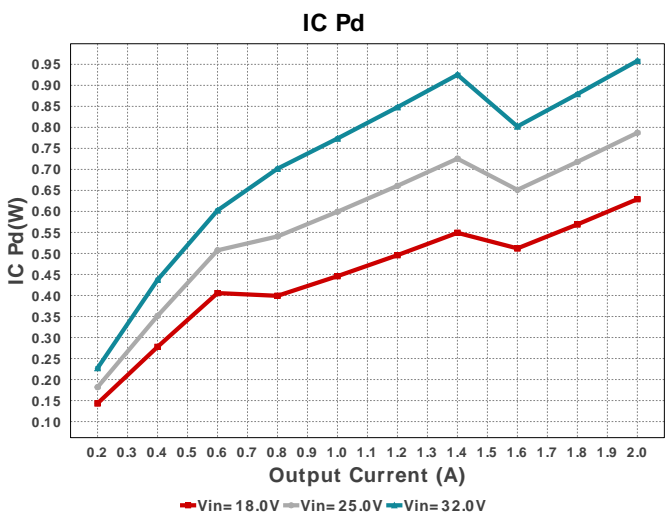
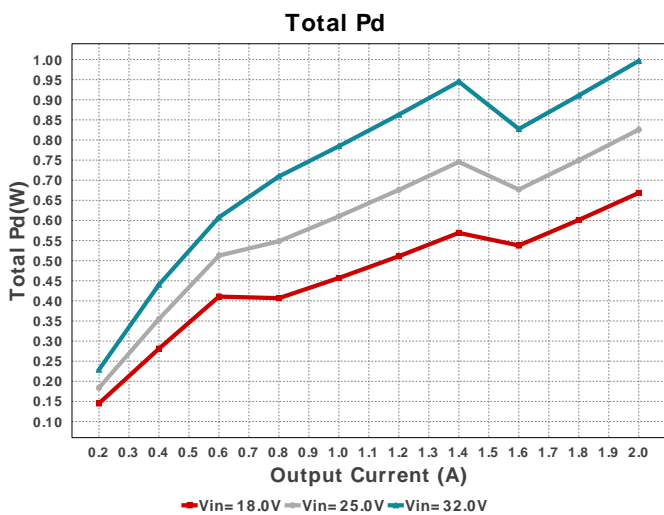
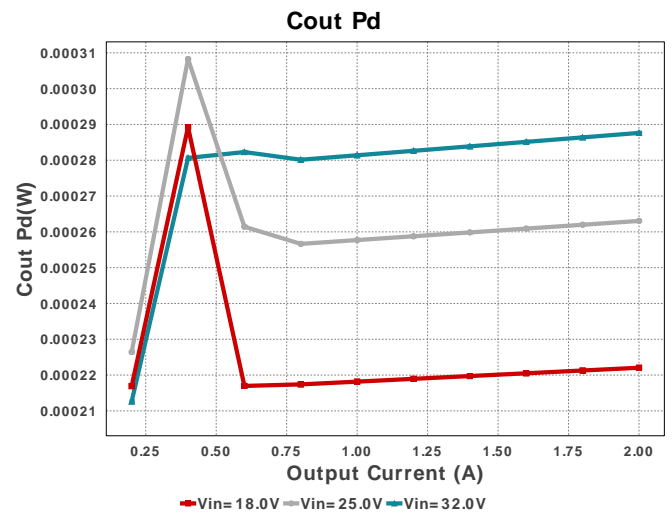
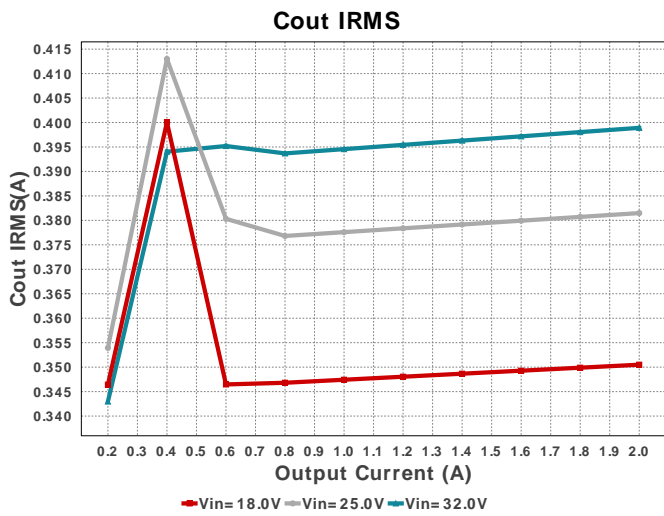
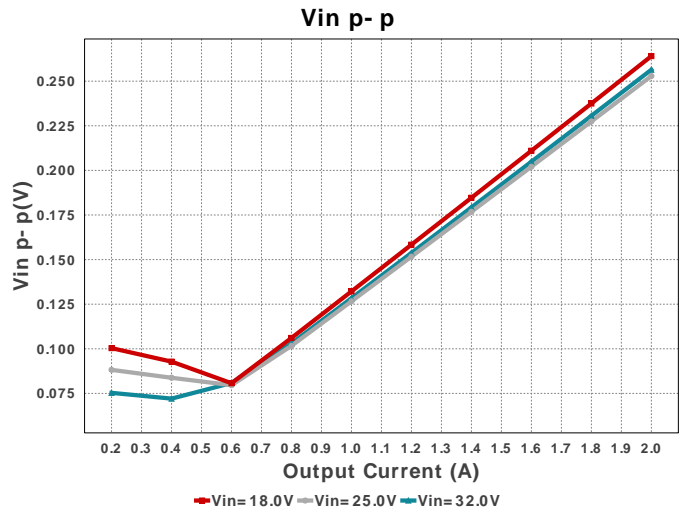
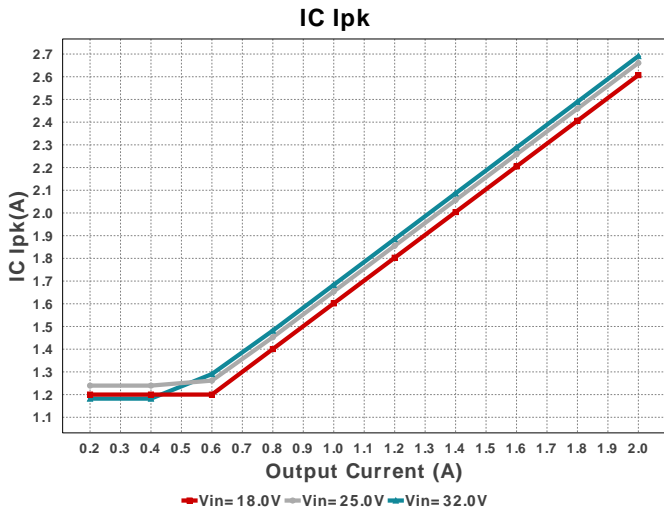



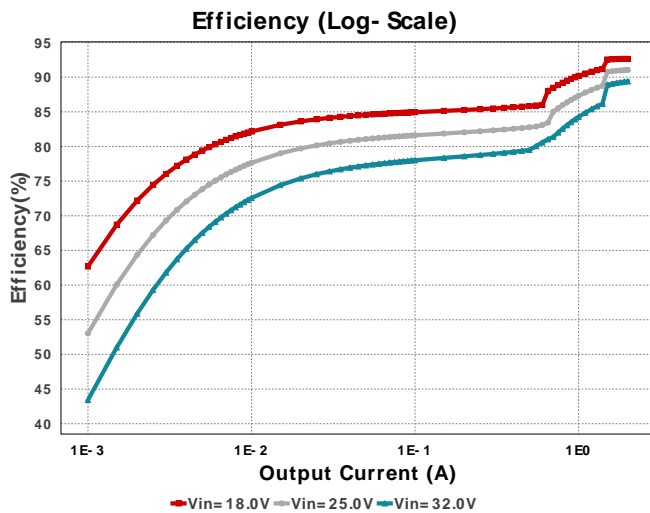
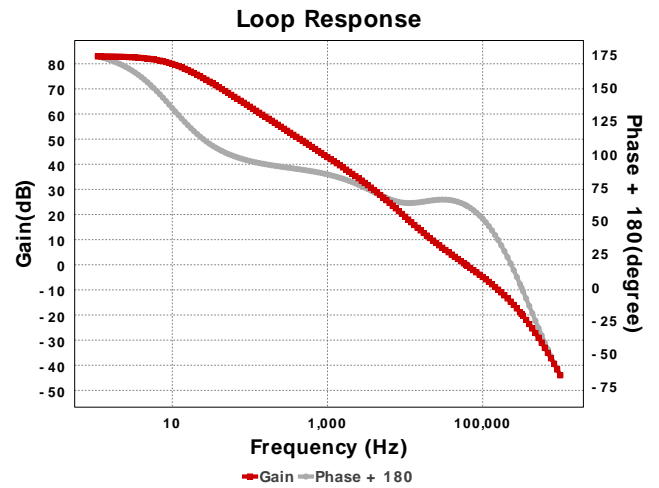
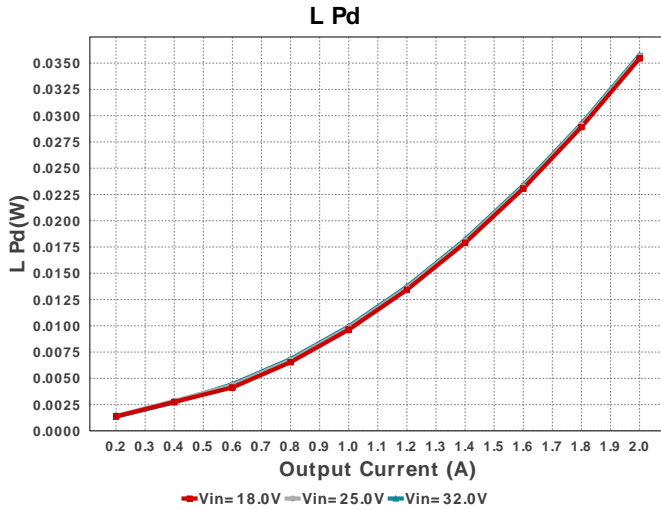

Operating Values

#	Name	Value	Category	Description
1.	BOM Count	15		Total Design BOM count
2.	Total BOM	\$3.03		Total BOM Cost
3.	Cin IRMS	698.741 mA	Capacitor	Input capacitor RMS ripple current
4.	Cin Pd	2.172 mW	Capacitor	Input capacitor power dissipation
5.	Cout IRMS	398.912 mA	Capacitor	Output capacitor RMS ripple current
6.	Cout Pd	287.63 μW	Capacitor	Output capacitor power dissipation
7.	IC Ipk	2.691 A	IC	Peak switch current in IC
8.	IC Pd	958.3 mW	IC	IC power dissipation
9.	IC Tj	53.958 degC	IC	IC junction temperature
10.	IC Tolerance	12.5 mV	IC	IC Feedback Tolerance
11.	ICThetaJA	25.0 degC/W	IC	IC junction-to-ambient thermal resistance
12.	Iin Avg	293.65 mA	IC	Average input current
13.	Ipp percentage	69.094 %	Inductor	Inductor ripple current percentage (with respect to average inductor current)
14.	L Ipp	1.382 A	Inductor	Peak-to-peak inductor ripple current
15.	L Pd	35.769 mW	Inductor	Inductor power dissipation
16.	Cin Pd	2.172 mW	Power	Input capacitor power dissipation
17.	Cout Pd	287.63 μW	Power	Output capacitor power dissipation
18.	IC Pd	958.3 mW	Power	IC power dissipation
19.	L Pd	35.769 mW	Power	Inductor power dissipation
20.	Total Pd	996.719 mW	Power	Total Power Dissipation
21.	Cross Freq	60.983 kHz	System	Bode plot crossover frequency
22.	Duty Cycle	13.489 %	System	Duty cycle
23.	Efficiency	89.393 %	System	Steady state efficiency
24.	FootPrint	187.0 mm ²	System	Total Foot Print Area of BOM components
25.	Frequency	818.527 kHz	System	Switching frequency

#	Name	Value	Category	Description
26.	Gain Marg	-19.595 dB	System Information	Bode Plot Gain Margin
27.	Iout	2.0 A	System Information	Iout operating point
28.	Low Freq Gain	82.918 dB	System Information	Gain at 1Hz
29.	Mode	CCM	System Information	Conduction Mode
30.	Phase Marg	61.831 deg	System Information	Bode Plot Phase Margin
31.	Pout	8.4 W	System Information	Total output power
32.	Vin	32.0 V	System Information	Vin operating point
33.	Vin p-p	256.437 mV	System Information	Peak-to-peak input voltage
34.	Vout	4.2 V	System Information	Operational Output Voltage
35.	Vout Actual	4.236 V	System Information	Vout Actual calculated based on selected voltage divider resistors
36.	Vout Tolerance	2.813 %	System Information	Vout Tolerance based on IC Tolerance (no load) and voltage divider resistors if applicable
37.	Vout p-p	11.462 mV	System Information	Peak-to-peak output ripple voltage

Design Inputs

Name	Value	Description
Iout	2.0	Maximum Output Current
VinMax	32.0	Maximum input voltage
VinMin	18.0	Minimum input voltage
Vout	4.2	Output Voltage
base_pn	LM61440	Base Product Number
source	DC	Input Source Type
Ta	30.0	Ambient temperature
UserFsw	800.0 k	Customer Selected Frequency

WEBENCH® Assembly

Component Testing

Some published data on components in datasheets such as Capacitor ESR and Inductor DC resistance is based on conservative values that will guarantee that the components always exceed the specification. For design purposes it is usually better to work with typical values. Since this data is not always available it is a good practice to measure the Capacitance and ESR values of C_{in} and C_{out} , and the inductance and DC resistance of L1 before assembly of the board. Any large discrepancies in values should be electrically simulated in WEBENCH to check for instabilities and thermally simulated in WebTHERM to make sure critical temperatures are not exceeded.

Soldering Component to Board

If board assembly is done in house it is best to tack down one terminal of a component on the board then solder the other terminal. For surface mount parts with large tabs, such as the DPAK, the tab on the back of the package should be pre-tinned with solder, then tacked into place by one of the pins. To solder the tab down to the board place the iron down on the board while resting against the tab, heating both surfaces simultaneously. Apply light pressure to the top of the plastic case until the solder flows around the part and the part is flush with the PCB. If the solder is not flowing around the board you may need a higher wattage iron (generally 25W to 30W is enough).

Initial Startup of Circuit

It is best to initially power up the board by setting the input supply voltage to the lowest operating input voltage 18.0V and set the input supply's current limit to zero. With the input supply off connect up the input supply to V_{in} and GND. Connect a digital volt meter and a load if needed to set the minimum load of the design from V_{out} and GND. Turn on the input supply and slowly turn up the current limit on the input supply. If the voltage starts to rise on the input supply continue increasing the input supply current limit while watching the output voltage. If the current increases on the input supply, but the voltage remains near zero, then there may be a short or a component misplaced on the board. Power down the board and visually inspect for solder bridges and recheck the diode and capacitor polarities. Once the power supply circuit is operational then more extensive testing may include full load testing, transient load and line tests to compare with simulation results.

Load Testing

The setup is the same as the initial startup, except that an additional digital voltmeter is connected between V_{in} and GND, a load is connected between V_{out} and GND and a current meter is connected in series between V_{out} and the load. The load must be able to handle at least rated output power + 50% (7.5 watts for this design). Ideally the load is supplied in the form of a variable load test unit. It can also be done in the form of suitably large power resistors. When using an oscilloscope to measure waveforms on the prototype board, the ground leads of the oscilloscope probes should be as short as possible and the area of the loop formed by the ground lead should be kept to a minimum. This will help reduce ground lead inductance and eliminate EMI noise that is not actually present in the circuit.



Design Assistance

1. Master key : AE3011FD2EE8F4EB[v1]
2. **LM61440** Product Folder : <http://www.ti.com/product/LM61440> : contains the data sheet and other resources.

Important Notice and Disclaimer

TI provides technical and reliability data (including datasheets), design resources (including reference designs), application or other design advice, web tools, safety information, and other resources AS IS and with all faults, and disclaims all warranties. These resources are intended for skilled developers designing with TI products. You are solely responsible for (1) selecting the appropriate TI products for your application, (2) designing, validating and testing your application, and (3) ensuring your application meets applicable standards, and any other safety, security, or other requirements.

These resources are subject to change without notice. TI grants you permission to use these resources only for development of an application that uses the TI products described in the resource. Other reproduction and display of these resources is prohibited. No license is granted to any other TI intellectual property right or to any third party intellectual property right. TI disclaims responsibility for, and you will fully indemnify TI and its representatives against, any claims, damages, costs, losses, and liabilities arising out of your use of these resources.

Providing these resources does not expand or otherwise alter TI's applicable Terms of Sale or other applicable terms available either on ti.com or provided in conjunction with TI products.