

## HSMF-C116

### Ultra Small Surface Mount Tricolor ChipLED

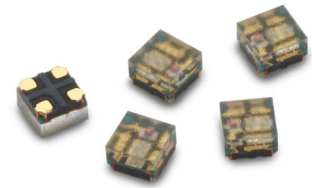

#### Description

The Broadcom® HSMF-C116 is an ultra-small tricolor chipLED designed for close pitch assembly and also for portable and wearables applications. The package uses high intensity red AlInGaP die and high intensity InGaN green and blue die. To improve contrast the PCB substrate has a black surface.

#### Features

- LED with AlInGaP and InGaN die
- Surface mount device with ultra small 1.0 mm × 1.0 mm footprint
- Suitable for application that requires small pitch size
- Compatible with reflow soldering
- Taped in 8-mm carrier tape on a 7-in. diameter reel

#### Applications

- Display
- Backlighting
- Indicator

Figure 1: Package Dimensions

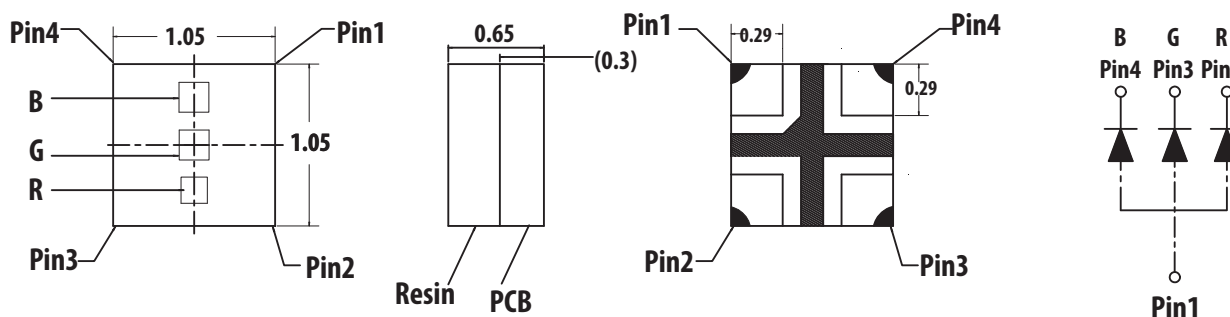

#### NOTE:

1. All dimensions are in millimeters.
2. Tolerance is  $\pm 0.1$  mm unless otherwise specified.

**CAUTION!** This LED is class 1A ESD sensitive per ANSI/ESDA/JEDEC JS-001. Please observe appropriate precautions during handling and processing. Refer to application note AN-1142 for additional details.

## Absolute Maximum Ratings ( $T_J = 25\text{ }^\circ\text{C}$ )

Parameter	AllInGaP Red	InGaN Green	InGaN Blue	Unit
DC Forward Current <sup>a</sup>	10	10	10	mA
Peak Forward Current <sup>b</sup>	60	60	60	mA
Power Dissipation	22	33	33	mW
LED Junction Temperature	95	95	95	$^\circ\text{C}$
Operating Temperature Range	-40 to 85			$^\circ\text{C}$
Storage Temperature Range	-40 to 85			$^\circ\text{C}$

a. Derate linearly as shown in Figure 8.

b. 1/10 duty factor and 0.1-ms pulse width.

## Optical Characteristics ( $T_J = 25\text{ }^\circ\text{C}$ , Red = 10 mA, Green/Blue = 5 mA)

Color	Luminous Intensity, $I_V$ (mcd) <sup>a</sup>			Peak Wavelength, $\lambda_p$ (nm)	Dominant Wavelength, $\lambda_d$ (nm) <sup>b</sup>	Viewing Angle, $2\theta_{1/2}$ ( $^\circ$ ) <sup>c</sup>
	Min.	Typ.	Max.	Typ.	Typ.	Typ.
Red	63.0	80.0	140.0	631	622	137
Green	135.0	220.0	315.0	520	528	140
Blue	24.0	45.0	63.0	466	471	140

a. The luminous intensity is measured at the mechanical axis of the LED package. The actual peak of the spatial radiation pattern may not be aligned with the axis.

b. The dominant wavelength is derived from the CIE chromaticity diagram and represents the perceived color of the device.

c.  $\theta_{1/2}$  is the off axis angle where the luminous intensity is  $1/2$  the peak intensity.

## Electrical Characteristics ( $T_J = 25\text{ }^\circ\text{C}$ , Red = 10 mA, Green/Blue = 5 mA)

Color	Forward Voltage, $V_F$ (V) <sup>a</sup>		Reverse Voltage, $V_R$ (V) at $I_R = 100\text{ }\mu\text{A}$ <sup>b</sup>
	Min.	Max.	Min.
Red	1.8	2.2	5
Green	2.5	3.3	5
Blue	2.7	3.3	5

a. Forward voltage tolerance  $\pm 0.1\text{V}$ .

b. Reverse voltage indicates product final test. Long-term reverse bias is not recommended.

## Bin Information

### Intensity Bin Limits (CAT)

Bin ID	Luminous Intensity, $I_v$ (mcd)	
	Min.	Max.
<b>Red</b>		
P9	63.0	100.0
Q	71.0	112.0
Q5	80.0	125.0
Q7	90.0	140.0
<b>Green</b>		
R5	135.0	217.0
R7	140.0	224.0
R9	159.0	250.0
S	180.0	280.0
S5	201.0	315.0
<b>Blue</b>		
M9	24.0	40.0
N	28.0	45.0
N5	32.0	50.0
N7	36.0	56.0
N9	40.0	63.0

Tolerance =  $\pm 15\%$ .

### Color Bin Limits (BIN)

Bin ID	Dominant Wavelength, $\lambda_d$ (nm)	
	Min.	Max.
<b>Red</b>		
1	615.0	627.0
<b>Green</b>		
2	523.0	529.0
3	525.0	531.0
4	528.0	534.0
5	530.0	536.0
6	533.0	539.0
<b>Blue</b>		
6	466.0	471.0
7	468.0	473.0
8	470.0	475.0

Tolerance =  $\pm 1$  nm.

#### CAUTION!

1. The above optical performance specifications are valid in the case where single LED is lit up.
2. The above product specifications *do not* provide any guarantee on color mixing, color consistency over time or uniformity in luminous intensity when more than one LED is lit up.

Figure 2: Spectral Power Distribution

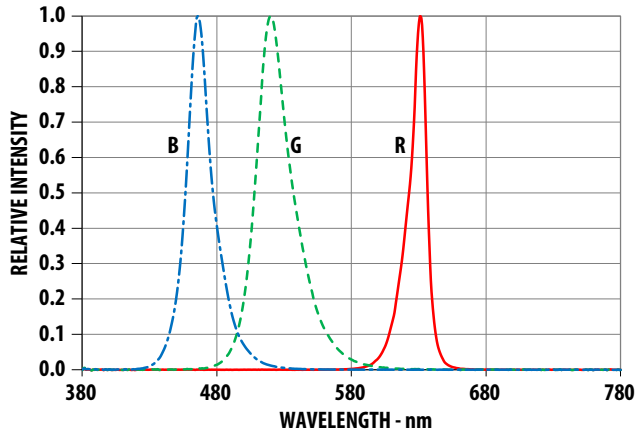

Figure 3: Relative Intensity vs. Forward Current

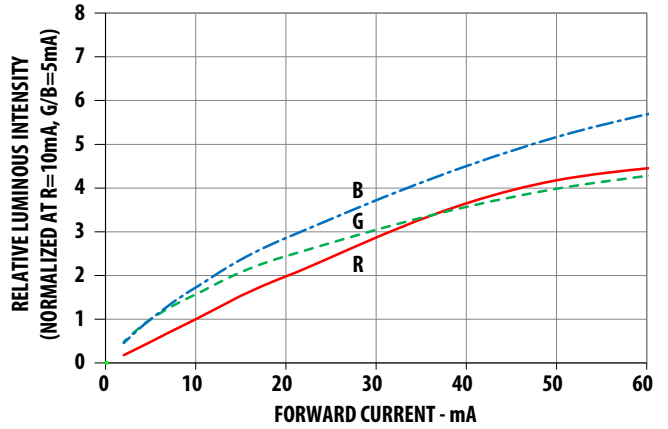

Figure 4: Forward Current vs. Forward Voltage

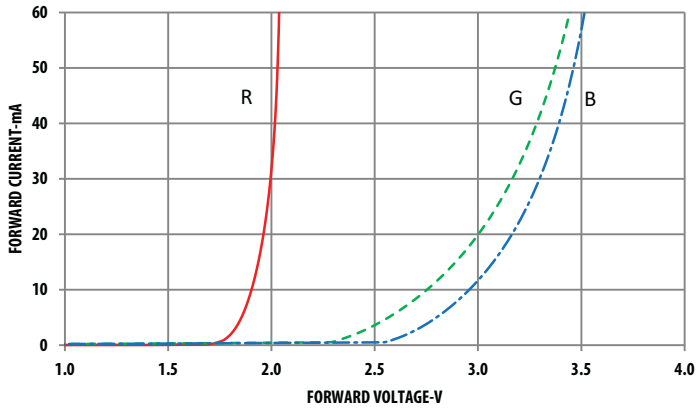

Figure 5: Dominant Wavelength Shift vs. Forward Current

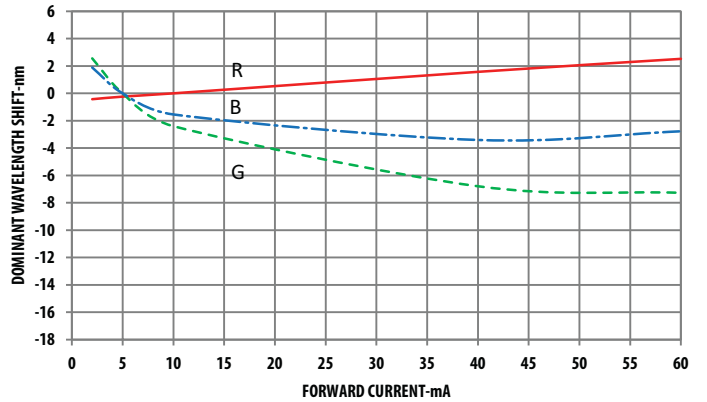

Figure 6: Radiation Pattern

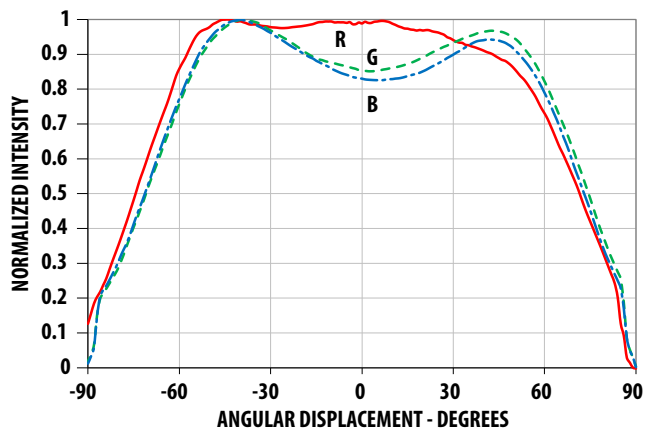

Figure 7: Relative Intensity vs. Temperature

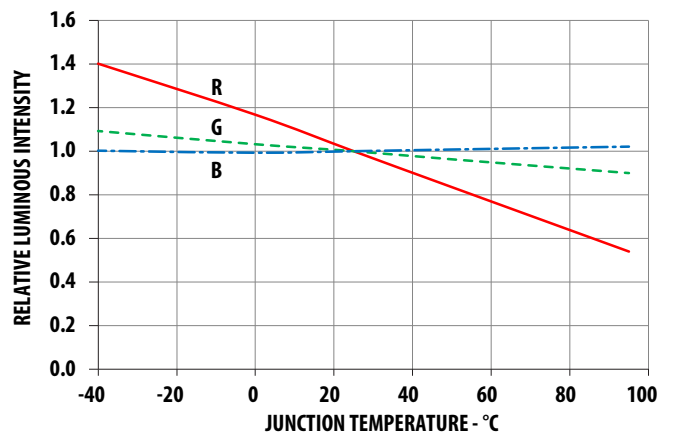

Figure 8: Derating Curve

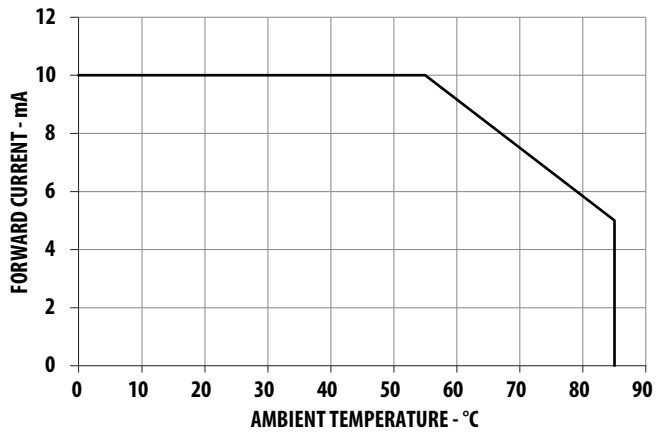

Figure 9: Recommended Soldering Land Pattern

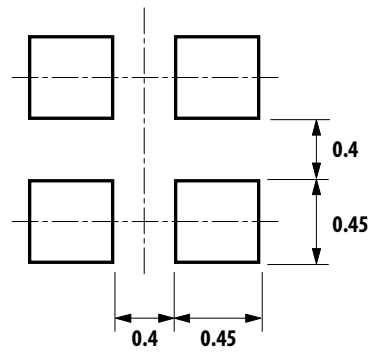

Figure 10: Carrier Tape Dimensions

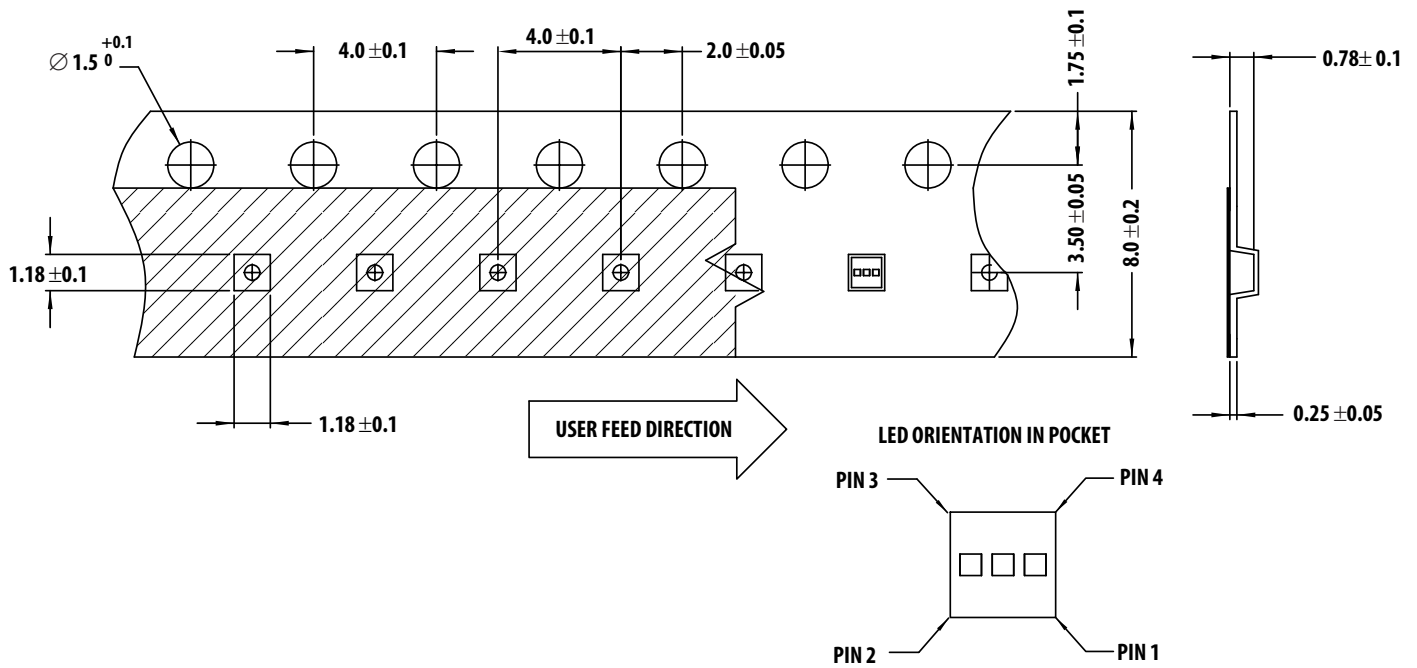
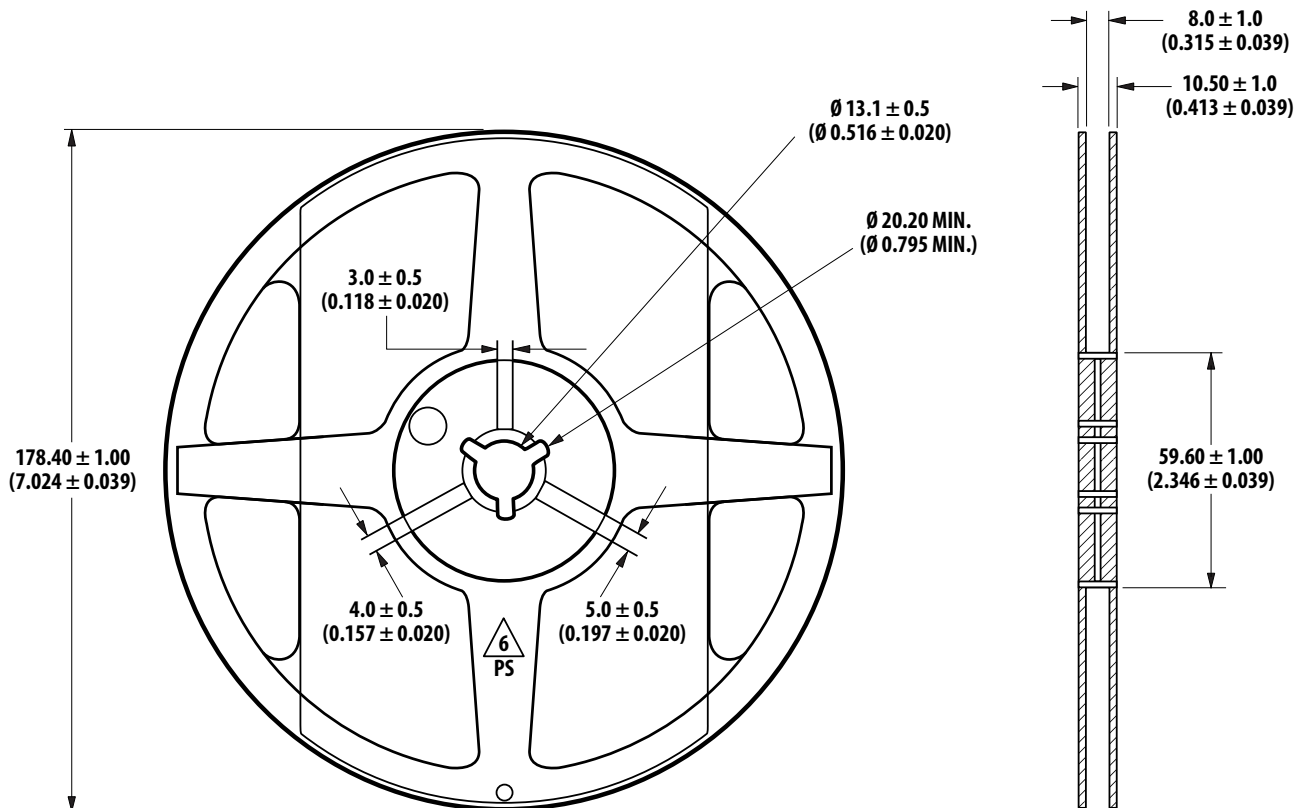

Figure 11: Reel Dimensions



## Precautionary Notes

### Soldering

- Do not perform reflow soldering more than twice. Observe necessary precautions of handling moisture-sensitive devices as stated in the following section.
- Do not apply any pressure or force on the LED during reflow and after reflow when the LED is still hot.
- Use reflow soldering to solder the LED. Use hand soldering only for rework if unavoidable, but it must be strictly controlled to following conditions:
  - Soldering iron tip temperature = 310°C maximum.
  - Soldering duration = 2 seconds maximum.
  - Number of cycles = 1 only.
  - Power of soldering iron = 50W maximum.
- Do not touch the LED package body with the soldering iron except for the soldering terminals, as it may cause damage to the LED.
- Confirm beforehand whether the functionality and performance of the LED is affected by soldering with hand soldering.

Figure 12: Recommended Lead-Free Reflow Soldering Profile

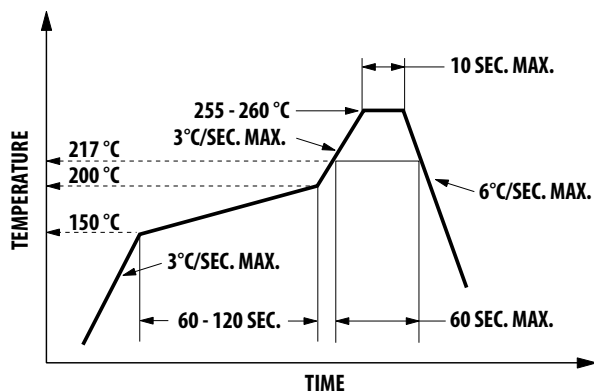

### Handling of Moisture Sensitive Devices

This product has a Moisture Sensitive Level 4 rating per JEDEC J-STD-020. Refer to Broadcom Application Note AN5305, *Handling of Moisture Sensitive Surface Mount Devices*, for additional details and a review of proper handling procedures.

#### Before use:

- An unopened moisture barrier bag (MBB) can be stored at <40°C/90% RH for 12 months. If the actual shelf life has exceeded 12 months and the humidity indicator card (HIC) indicates that baking is not required, it is safe to reflow the LEDs per the original MSL rating.
- Do not open the MBB prior to assembly (for example, for IQC). If unavoidable, the MBB must be properly resealed with fresh desiccant and HIC. The exposed duration must be taken in as floor life.

#### Control after opening the MBB:

- Read the HIC immediately upon opening of the MBB.
- Keep the LEDs at <30°/60% RH at all times, and complete all high temperature-related processes, including soldering, curing, or rework within 72 hours.

#### Control for unfinished reel:

Store unused LEDs in a sealed MBB with desiccant or a desiccator at <5% RH.

#### Control of assembled boards:

If the PCB soldered with the LEDs is to be subjected to other high-temperature processes, store the PCB in a sealed MBB with desiccant or desiccator at <5% RH to ensure that all LEDs have not exceeded their floor life of 72 hours.

#### Baking is required if the following conditions exist:

- The HIC indicator indicates a change in color for 10% and 5%, as stated on the HIC.
- The LEDs are exposed to conditions of >30°C/60% RH at any time.
- The LEDs' floor life exceeded 72 hours.

The recommended baking condition is: 60°C ± 5°C for 20 hrs.

Baking should only be done once.

## Application Precautions

- The drive current of the LED must not exceed the maximum allowable limit across temperature as stated in the data sheet. Constant current driving is recommended to ensure consistent performance.
- Circuit design must cater to the whole range of forward voltage ( $V_F$ ) of the LEDs to ensure the intended drive current can always be achieved.
- The LED exhibits slightly different characteristics at different drive currents, which may result in a larger variation of performance (intensity, wavelength, and forward voltage). Set the application current as close as possible to the test current to minimize these variations.
- The LED is not intended for reverse bias. Use other appropriate components for such purposes. When driving the LED in matrix form, ensure that the reverse bias voltage does not exceed the allowable limit of the LED.
- Avoid rapid changes in ambient temperature, especially in high-humidity environments, because they cause condensation on the LED.
- If the LED is intended to be used in harsh or outdoor environments, protect the LED against damages caused by rain water, water, dust, oil, corrosive gases, external mechanical stresses, and so on.

## Eye Safety Precautions

LEDs may pose optical hazards when in operation. Do not look directly at operating LEDs because it might be harmful to the eyes. For safety reasons, use appropriate shielding or personal protective equipment.



## Disclaimer

Broadcom's products and software are not specifically designed, manufactured, or authorized for sale as parts, components, or assemblies for the planning, construction, maintenance, or direct operation of a nuclear facility or for use in medical devices or applications. The customer is solely responsible, and waives all rights to make claims against Broadcom or its suppliers, for all loss, damage, expense, or liability in connection with such use.

Broadcom, the pulse logo, Connecting everything, Avago Technologies, Avago, and the A logo are among the trademarks of Broadcom and/or its affiliates in the United States, certain other countries, and/or the EU.

Copyright © 2015–2019 Broadcom. All Rights Reserved.

The term “Broadcom” refers to Broadcom Inc. and/or its subsidiaries. For more information, please visit [www.broadcom.com](http://www.broadcom.com).

Broadcom reserves the right to make changes without further notice to any products or data herein to improve reliability, function, or design. Information furnished by Broadcom is believed to be accurate and reliable. However, Broadcom does not assume any liability arising out of the application or use of this information, nor the application or use of any product or circuit described herein, neither does it convey any license under its patent rights nor the rights of others.



# Mouser Electronics

Authorized Distributor

Click to View Pricing, Inventory, Delivery & Lifecycle Information:

[Broadcom Limited:](#)

[HSMF-C116](#)