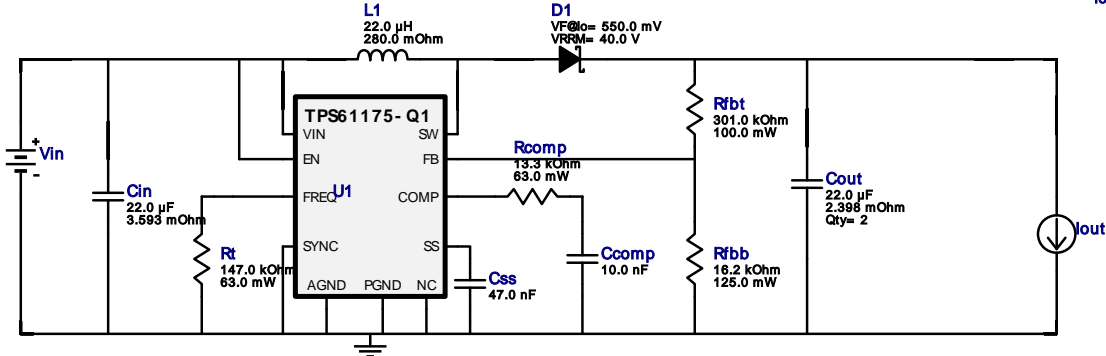

WEBENCH® Design Report

 Design : 24 TPS61175QPWPRQ1
 TPS61175QPWPRQ1 3.3V-3.7V to 24.00V @ 0.12A

 Vout = 24.0V
 Iout = 0.12A

1. This regulator device is qualified for Automotive applications. All passives and other components selected in this design may not be qualified for Automotive applications. The user is required to verify that all components in the design meet the qualification and safety requirements for their specific application. View WEBENCH(R) Disclaimer.

Design Alerts

Component Selection Information

The TPS61175-Q1 is qualified for Automotive applications. All passives and other components selected in this design may not be qualified for Automotive applications. The user is required to verify that all components in the design meet the qualification and safety requirements for their specific application. View WEBENCH(R) Disclaimer

Electrical BOM

Name	Manufacturer	Part Number	Properties	Qty	Price	Footprint
Ccomp	Kemet	C0805C103J3GACTU Series= C0G/NP0	Cap= 10.0 nF VDC= 25.0 V IRMS= 0.0 A	1	\$0.09	0805 7 mm ²
Cin	MuRata	GRM31CR70J226KE19L Series= X7R	Cap= 22.0 uF ESR= 3.593 mOhm VDC= 6.3 V IRMS= 3.44359 A	1	\$0.37	1206_190 11 mm ²
Cout	TDK	C3216X5R1V226M160AC Series= X5R	Cap= 22.0 uF ESR= 2.398 mOhm VDC= 35.0 V IRMS= 4.6851 A	2	\$0.35	1206_180 11 mm ²
Css	Kemet	C0805C473J3GACTU Series= C0G/NP0	Cap= 47.0 nF VDC= 25.0 V IRMS= 0.0 A	1	\$0.23	0805 7 mm ²
D1	Fairchild Semiconductor	SS24FL	VF@Io= 550.0 mV VRRM= 40.0 V	1	\$0.05	SOD-123F 12 mm ²
L1	Würth Elektronik	74438356220	L= 22.0 uH 280.0 mOhm	1	\$1.23	WE-MAPI_4020 26 mm ²
Rcomp	Vishay-Dale	CRCW040213K3FKED Series= CRCW..e3	Res= 13.3 kOhm Power= 63.0 mW Tolerance= 1.0%	1	\$0.01	0402 3 mm ²
Rfbb	Yageo	RT0805BRD0716K2L Series= ?	Res= 16.2 kOhm Power= 125.0 mW Tolerance= 0.1%	1	\$0.05	0805 7 mm ²
Rfbt	Susumu Co Ltd	RG1608P-3013-B-T5 Series= RG1608	Res= 301.0 kOhm Power= 100.0 mW Tolerance= 0.1%	1	\$0.06	0603 5 mm ²

Name	Manufacturer	Part Number	Properties	Qty	Price	Footprint
Rt	Vishay-Dale	CRCW0402147KFKED Series= CRCW..e3	Res= 147.0 kOhm Power= 63.0 mW Tolerance= 1.0%	1	\$0.01	0402 3 mm ²
U1	Texas Instruments	TPS61175QPWPRQ1	Switcher	1	\$1.35	 R-PDSO-G14 61 mm ²

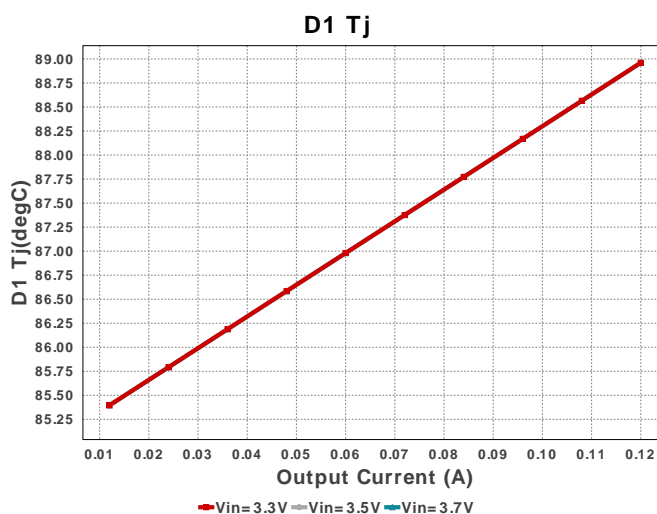
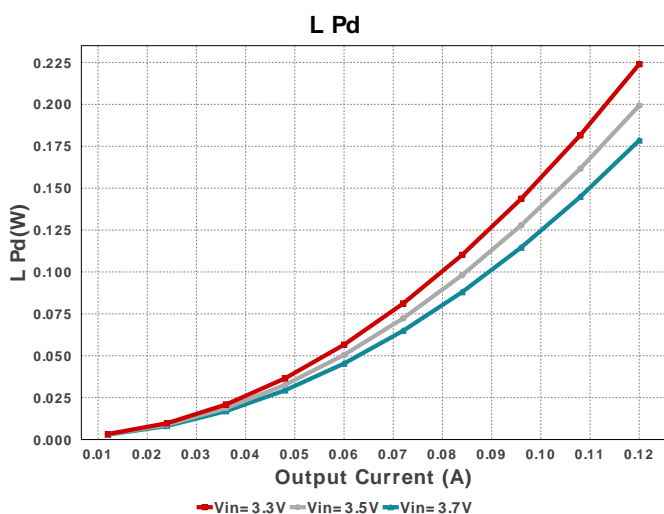
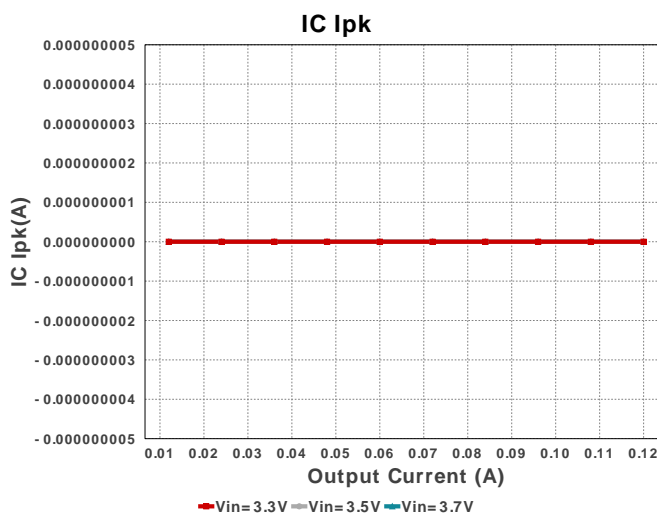
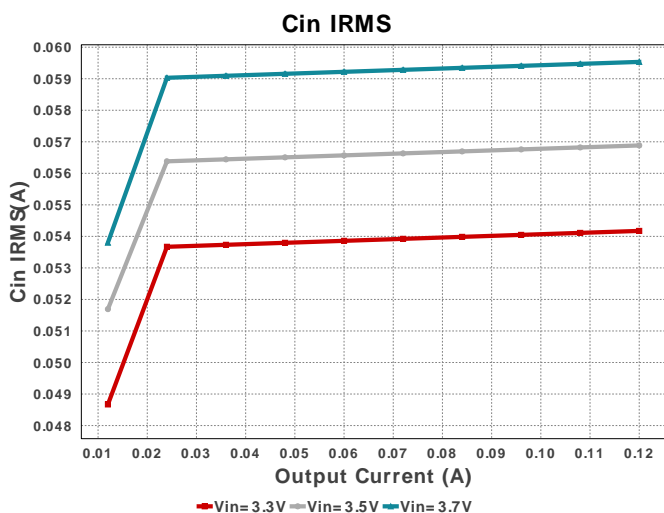
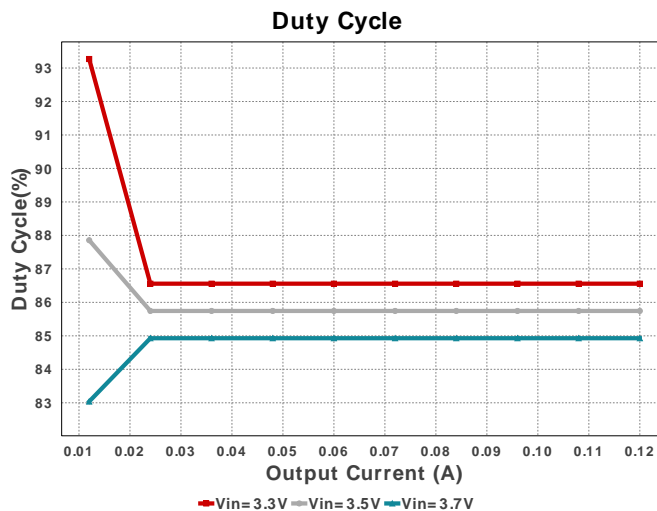
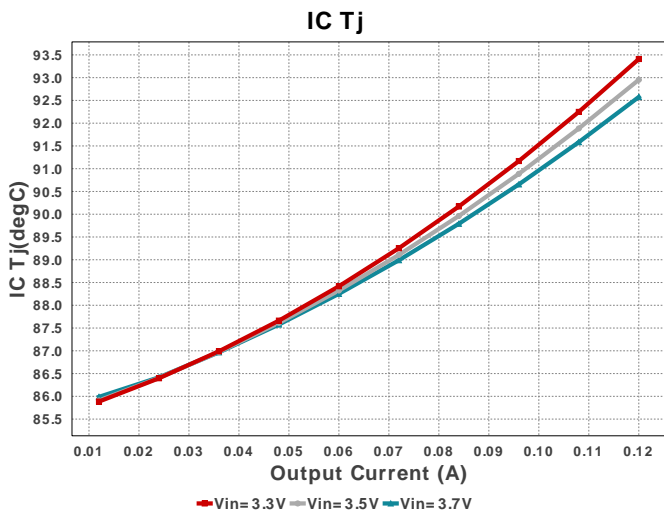

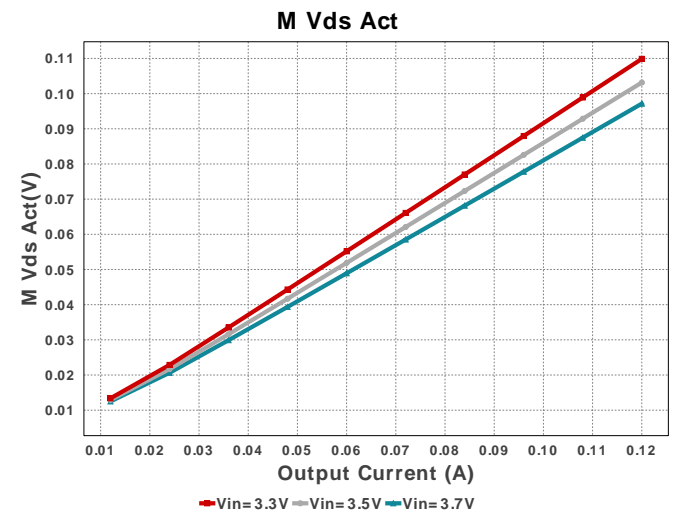
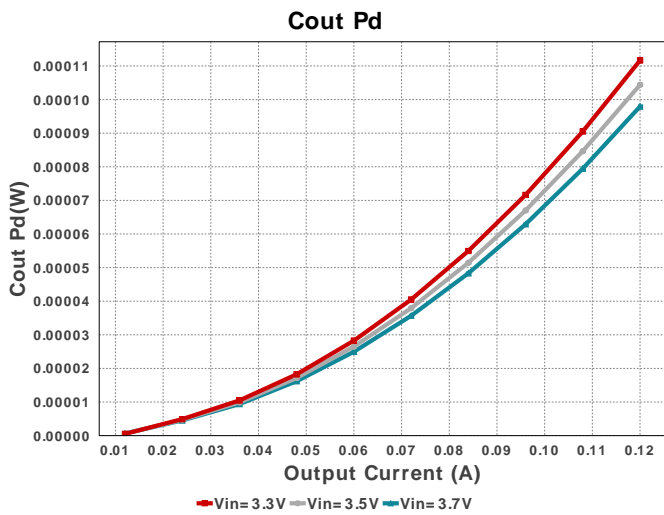
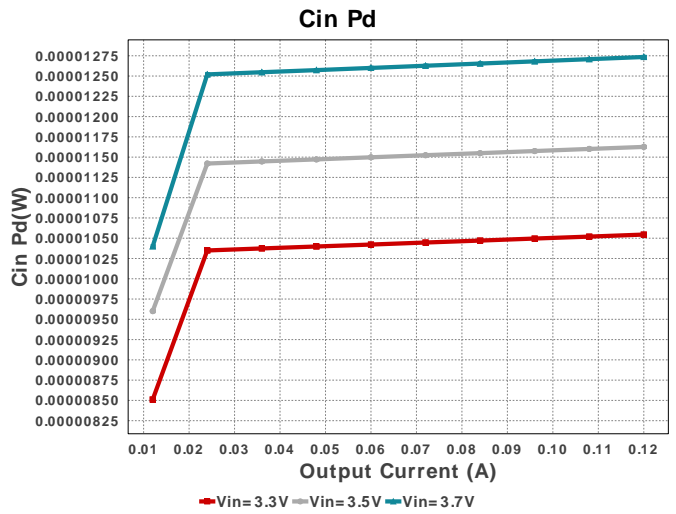
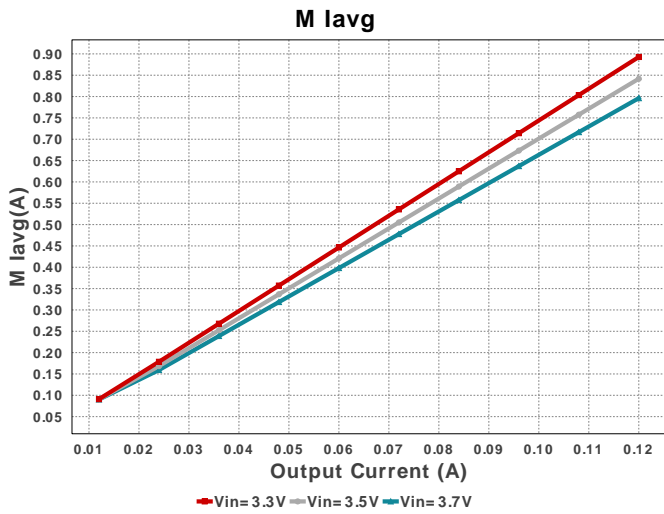
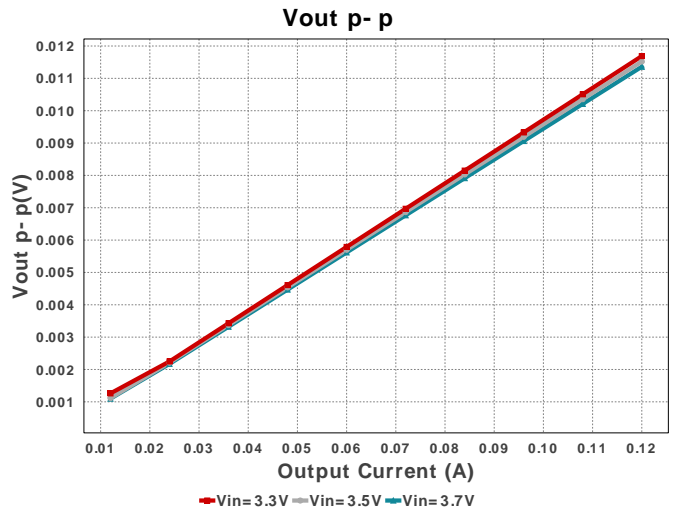
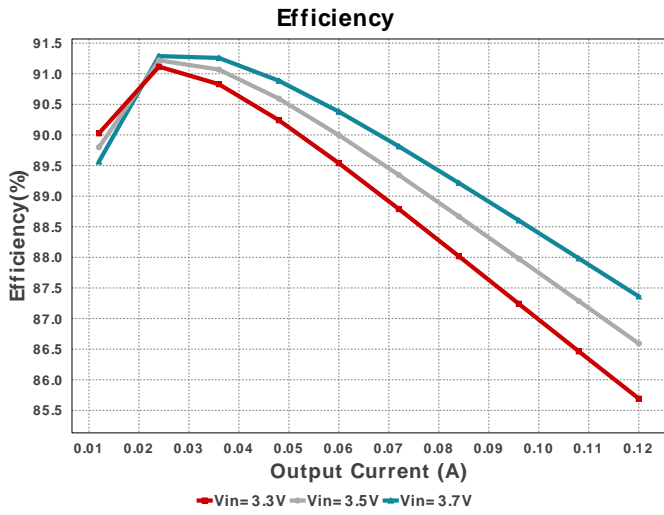

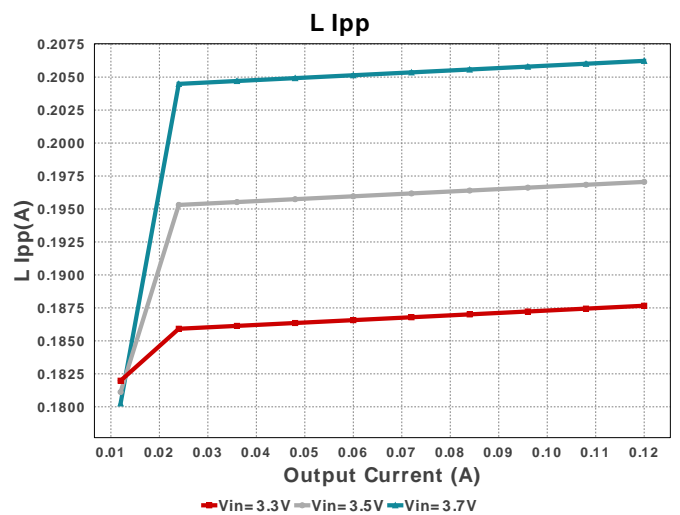
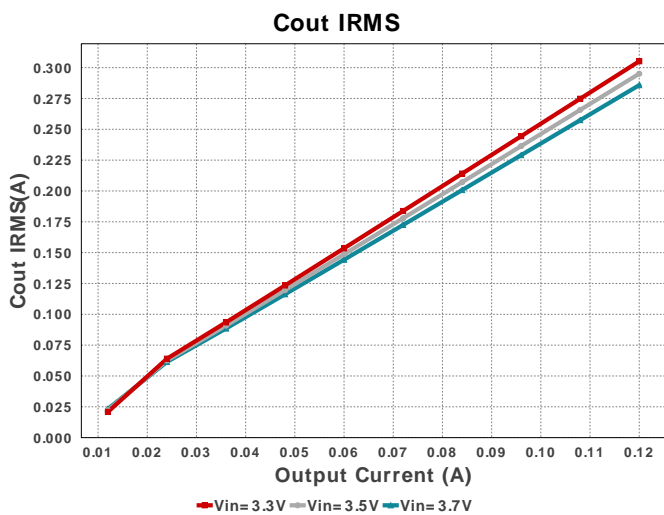
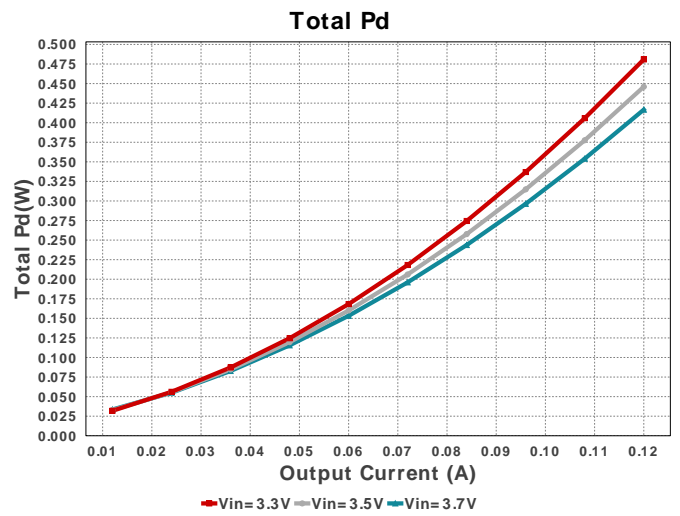
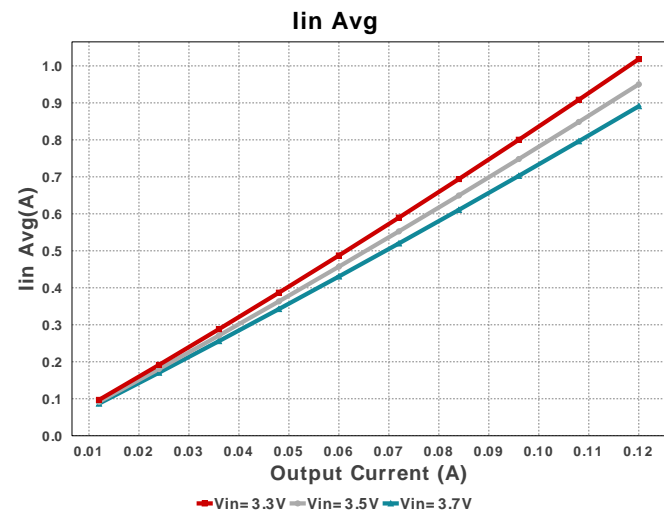
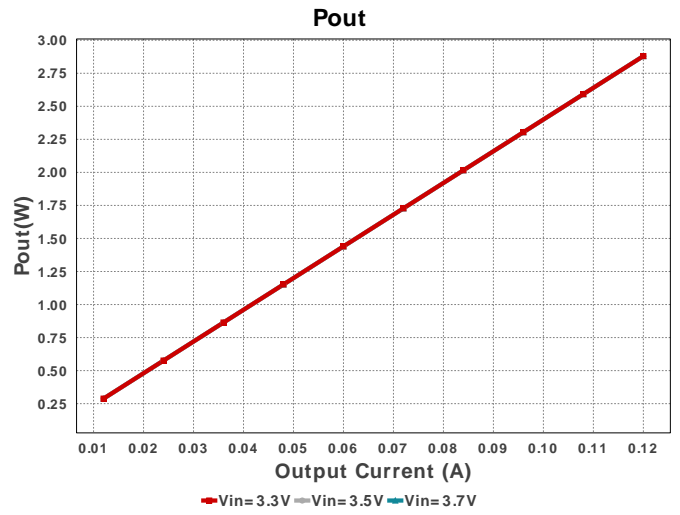
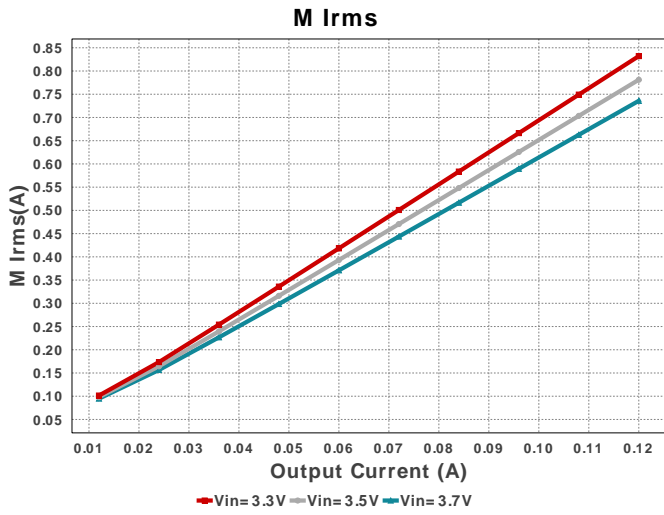

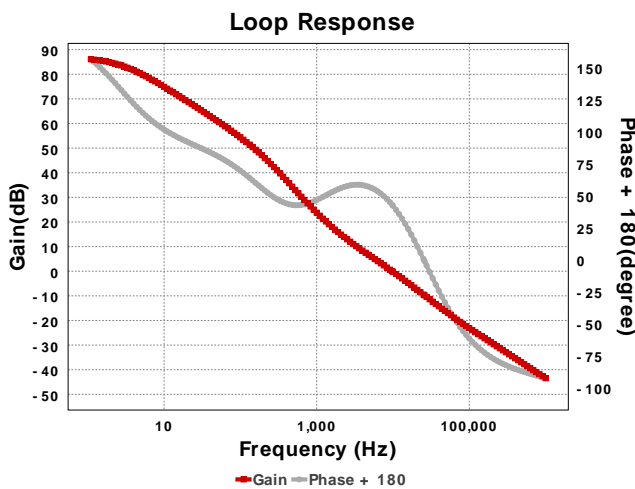
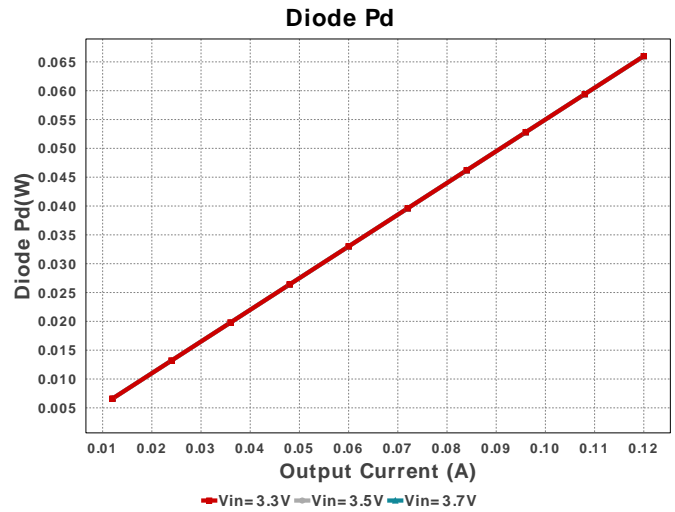
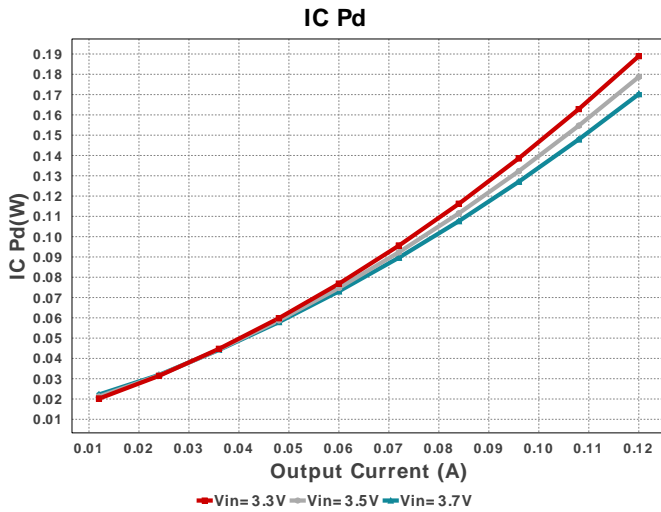

Operating Values

#	Name	Value	Category	Description
1.	BOM Count	12		Total Design BOM count
2.	Total BOM	\$4.15		Total BOM Cost
3.	Cin IRMS	54.174 mA	Capacitor	Input capacitor RMS ripple current
4.	Cin Pd	10.545 μ W	Capacitor	Input capacitor power dissipation
5.	Cout IRMS	305.159 mA	Capacitor	Output capacitor RMS ripple current
6.	Cout Pd	111.65 μ W	Capacitor	Output capacitor power dissipation
7.	D1 Tj	88.96 degC	Diode	D1 junction temperature
8.	Diode Pd	66.0 mW	Diode	Diode power dissipation
9.	IC Ipk	0.0 A	IC	Peak switch current in IC
10.	IC Pd	188.97 mW	IC	IC power dissipation
11.	IC Tj	93.409 degC	IC	IC junction temperature
12.	IC Tolerance	20.0 mV	IC	IC Feedback Tolerance
13.	ICThetaJA	44.5 degC/W	IC	IC junction-to-ambient thermal resistance
14.	Iin Avg	1.018 A	IC	Average input current
15.	L Ipp	187.663 mA	Inductor	Peak-to-peak inductor ripple current
16.	L Pd	223.97 mW	Inductor	Inductor power dissipation
17.	M Iavg	892.727 mA	Mosfet	MOSFET Average current
18.	M Irms	832.091 mA	Mosfet	MOSFET RMS ripple current
19.	M Vds Act	109.879 mV	Mosfet	Voltage drop across the MosFET
20.	Cin Pd	10.545 μ W	Power	Input capacitor power dissipation
21.	Cout Pd	111.65 μ W	Power	Output capacitor power dissipation
22.	Diode Pd	66.0 mW	Power	Diode power dissipation
23.	IC Pd	188.97 mW	Power	IC power dissipation
24.	L Pd	223.97 mW	Power	Inductor power dissipation
25.	Total Pd	480.852 mW	Power	Total Power Dissipation
26.	Cross Freq	8.847 kHz	System	Bode plot crossover frequency
27.	Duty Cycle	86.558 %	Information System	Duty cycle
28.	Efficiency	85.692 %	Information System	Steady state efficiency

#	Name	Value	Category	Description
29.	FootPrint	162.0 mm ²	System Information	Total Foot Print Area of BOM components
30.	Frequency	700.0 kHz	System Information	Switching frequency
31.	Gain Marg	-8.757 dB	System Information	Bode Plot Gain Margin
32.	Iout	120.0 mA	System Information	Iout operating point
33.	Low Freq Gain	85.661 dB	System Information	Gain at 1Hz
34.	Mode	CCM	System Information	Conduction Mode
35.	Phase Marg	41.421 deg	System Information	Bode Plot Phase Margin
36.	Pout	2.88 W	System Information	Total output power
37.	Vin	3.3 V	System Information	Vin operating point
38.	Vout	24.0 V	System Information	Operational Output Voltage
39.	Vout Actual	24.064 V	System Information	Vout Actual calculated based on selected voltage divider resistors
40.	Vout Tolerance	1.82 %	System Information	Vout Tolerance based on IC Tolerance (no load) and voltage divider resistors if applicable
41.	Vout p-p	11.688 mV	System Information	Peak-to-peak output ripple voltage

Design Inputs

Name	Value	Description
Iout	120.0 m	Maximum Output Current
VinMax	3.7	Maximum input voltage
VinMin	3.3	Minimum input voltage
Vout	24.0	Output Voltage
base_pn	TPS61175-Q1	Base Product Number
source	DC	Input Source Type
Ta	85.0	Ambient temperature
UserFsw	700.0 k	Customer Selected Frequency

WEBENCH® Assembly

Component Testing

Some published data on components in datasheets such as Capacitor ESR and Inductor DC resistance is based on conservative values that will guarantee that the components always exceed the specification. For design purposes it is usually better to work with typical values. Since this data is not always available it is a good practice to measure the Capacitance and ESR values of C_{in} and C_{out} , and the inductance and DC resistance of L1 before assembly of the board. Any large discrepancies in values should be electrically simulated in WEBENCH to check for instabilities and thermally simulated in WebTHERM to make sure critical temperatures are not exceeded.

Soldering Component to Board

If board assembly is done in house it is best to tack down one terminal of a component on the board then solder the other terminal. For surface mount parts with large tabs, such as the DPAK, the tab on the back of the package should be pre-tinned with solder, then tacked into place by one of the pins. To solder the tab down to the board place the iron down on the board while resting against the tab, heating both surfaces simultaneously. Apply light pressure to the top of the plastic case until the solder flows around the part and the part is flush with the PCB. If the solder is not flowing around the board you may need a higher wattage iron (generally 25W to 30W is enough).

Initial Startup of Circuit

It is best to initially power up the board by setting the input supply voltage to the lowest operating input voltage 3.3V and set the input supply's current limit to zero. With the input supply off connect up the input supply to V_{in} and GND. Connect a digital volt meter and a load if needed to set the minimum load of the design from V_{out} and GND. Turn on the input supply and slowly turn up the current limit on the input supply. If the voltage starts to rise on the input supply continue increasing the input supply current limit while watching the output voltage. If the current increases on the input supply, but the voltage remains near zero, then there may be a short or a component misplaced on the board. Power down the board and visually inspect for solder bridges and recheck the diode and capacitor polarities. Once the power supply circuit is operational then more extensive testing may include full load testing, transient load and line tests to compare with simulation results.

Load Testing

The setup is the same as the initial startup, except that an additional digital voltmeter is connected between V_{in} and GND, a load is connected between V_{out} and GND and a current meter is connected in series between V_{out} and the load. The load must be able to handle at least rated output power + 50% (7.5 watts for this design). Ideally the load is supplied in the form of a variable load test unit. It can also be done in the form of suitably large power resistors. When using an oscilloscope to measure waveforms on the prototype board, the ground leads of the oscilloscope probes should be as short as possible and the area of the loop formed by the ground lead should be kept to a minimum. This will help reduce ground lead inductance and eliminate EMI noise that is not actually present in the circuit.



Design Assistance

1. The TPS61175-Q1 is qualified for Automotive applications. All passives and other components selected in this design may not be qualified for Automotive applications. The user is required to verify that all components in the design meet the qualification and safety requirements for their specific application
2. Master key : 202DDE02F07E0483[v1]
3. **TPS61175-Q1** Product Folder : <http://www.ti.com/product/TPS61175%2DQ1> : contains the data sheet and other resources.

Important Notice and Disclaimer

TI provides technical and reliability data (including datasheets), design resources (including reference designs), application or other design advice, web tools, safety information, and other resources AS IS and with all faults, and disclaims all warranties. These resources are intended for skilled developers designing with TI products. You are solely responsible for (1) selecting the appropriate TI products for your application, (2) designing, validating and testing your application, and (3) ensuring your application meets applicable standards, and any other safety, security, or other requirements.

These resources are subject to change without notice. TI grants you permission to use these resources only for development of an application that uses the TI products described in the resource. Other reproduction and display of these resources is prohibited. No license is granted to any other TI intellectual property right or to any third party intellectual property right. TI disclaims responsibility for, and you will fully indemnify TI and its representatives against, any claims, damages, costs, losses, and liabilities arising out of your use of these resources.

Providing these resources does not expand or otherwise alter TI's applicable Terms of Sale or other applicable terms available either on ti.com or provided in conjunction with TI products.