

Electrical Specification @ 25°C:

Inductance:	(1,2-3,4): 1 $\mu\text{H} \pm 10\%$ @ 100KHz, 0.1V
Leakage Inductance:	(1,2-3,4): 0.028 μH Max @ 100KHz, 0.1V, with all other pins shorted
RDC:	(1,2-3,4): 5.0 m Ω Max (5,6-7,8): 24.0 m Ω Max
Turns Ratio:	(1,2-3,4):(5,6-7,8)=1:2.5 $\pm 5\%$ @ 100KHz, 0.1V
Hipot:	(1,2,3,4) to pins (5,6,7,8) shorted: 1,500Vac for 2 Sec. @ 0.5mA

Schematic:

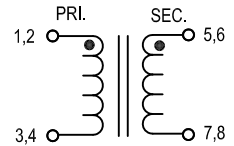

Mechanical Specification:

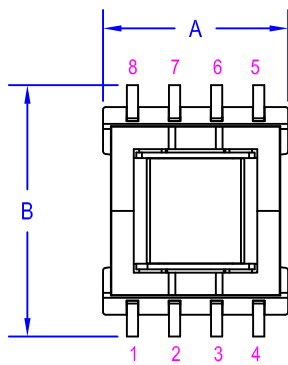

Top View

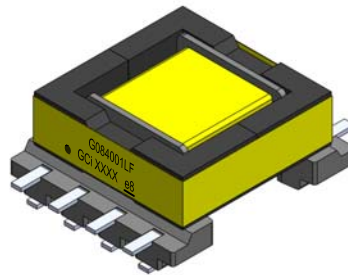

Notes:

- Marking shall include:
GCI Part Number,
GCI Name, Date Code,
RoHS Symbol.

Marking

G084001LF GCI XXXX e1

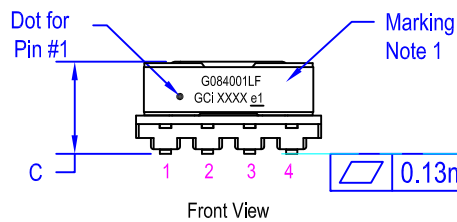

Front View

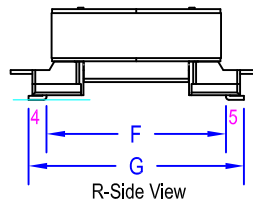

R-Side View

Dimensions Table

Ref	mm
A	18.00 Max
B	23.90 Max
C	9.50 Max
D	(1.00 x 0.35) ± 0.10
E	3.75 ± 0.25
F	16.00 ± 0.20
G	19.20 ± 0.20

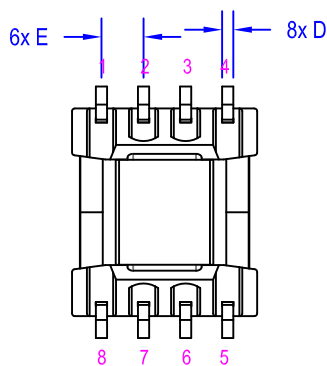

Bottom View

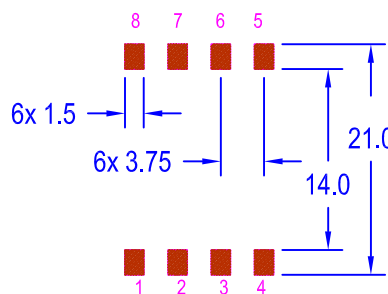

* Suggested PCB Layout

"ALL CURRENT CHANGES INDICATED BY ASTERISKS"

Electrical / Mechanical Requirements

FLYBACK TRANSFORMER

DESIGN ENG: <i>Javier H.</i>	APPD. BY: <i>Dean Gray</i>	RELEASED BY:	REV: 2	DRAFTER: <i>June W.</i>	DATE: 09/26/19
S/O NUMBER: 084001	GCI PART NO: G084001LF	CUSTOMER PART NO.:			SHEET 1 OF 1



****Proprietary & Confidentiality Notice****
This document contains GCI Technologies, Inc. proprietary and confidential data and is not to be copied, reproduced, used, or divulged to unauthorized persons, in whole or in part without proper written authorization from GCI Technologies, Inc. GCI Technologies, Inc. reserves all rights herein.

