

WEBENCH® Design Report

 Design : 31 LM5023MMX-2/NOPB
 LM5023MMX-2/NOPB 85V-300V to 12.00V @ 2A

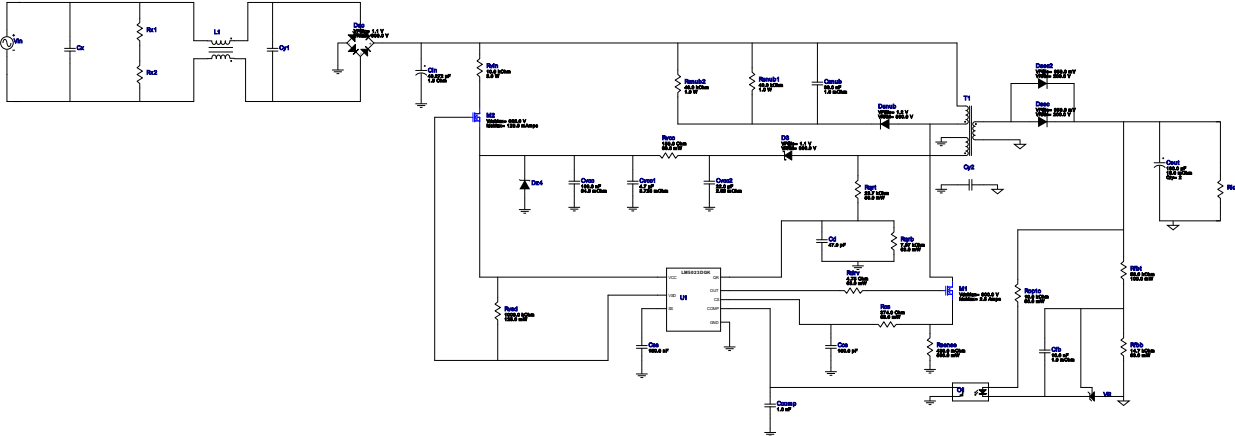

1. The EMI filter shown in the schematic is a placeholder. It has not yet been designed for the application.

Design Alerts

Component Selection Information

Click on the transformer symbol in the schematic and select "Explore Transformer Core/Bobbin Selection" to design using specific transformer cores and bobbin.

Electrical BOM

Name	Manufacturer	Part Number	Properties	Qty	Price	Footprint
Ccomp	MuRata	GRM1555C1H102JA01J Series= C0G/NP0	Cap= 1.0 nF VDC= 50.0 V IRMS= 0.0 A	1	\$0.01	0402 3 mm ²
Ccs	Samsung Electro-Mechanics	CL21C101JBANNNC Series= C0G/NP0	Cap= 100.0 pF VDC= 50.0 V IRMS= 0.0 A	1	\$0.01	0805 7 mm ²
Cd	Samsung Electro-Mechanics	CL21C470JBANNNC Series= C0G/NP0	Cap= 47.0 pF VDC= 50.0 V IRMS= 0.0 A	1	\$0.01	0805 7 mm ²
Cfb	MuRata	GRM033R70J103KA01D Series= X7R	Cap= 10.0 nF ESR= 1.0 mOhm VDC= 6.3 V IRMS= 0.0 A	1	\$0.01	0201 2 mm ²
Cin	CUSTOM	CUSTOM Series= ?	Cap= 40.272 uF ESR= 1.5005 Ohm VDC= 445.47 V IRMS= 659.4 mA	1	NA	CUSTOM 0 mm ²
Cout	Panasonic	25SVPF180M Series= SVPF	Cap= 180.0 uF ESR= 16.0 mOhm VDC= 25.0 V IRMS= 4.65 A	2	\$0.63	 CAPSMT_62_E12 106 mm ²
Csnub	MuRata	GRM32DR72J333KW01L Series= X7R	Cap= 33.0 nF ESR= 1.0 mOhm VDC= 630.0 V IRMS= 0.0 A	1	\$0.13	1210 15 mm ²
Css	Panasonic	EPCU1C154MA5 Series= EPCU(A)	Cap= 150.0 nF VDC= 16.0 V IRMS= 0.0 A	1	\$0.17	 1206 11 mm ²

Name	Manufacturer	Part Number	Properties	Qty	Price	Footprint
Cvcc	Kemet	C0805C104M5RACTU Series= X7R	Cap= 100.0 nF ESR= 64.0 mOhm VDC= 50.0 V IRMS= 1.64 A	1	\$0.01	 0805 7 mm ²
Cvcc1	TDK	C1608X5R1V475K080AC Series= X5R	Cap= 4.7 uF ESR= 3.728 mOhm VDC= 35.0 V IRMS= 2.69359 A	1	\$0.10	 0603 5 mm ²
Cvcc2	TDK	C2012X5R1V226M125AC Series= X5R	Cap= 22.0 uF ESR= 2.05 mOhm VDC= 35.0 V IRMS= 4.5559 A	1	\$0.33	 0805 7 mm ²
D3	SMC Diode Solutions	ST1300ATR	VF@Io= 1.1 V VRRM= 300.0 V	1	\$0.07	 SMA 37 mm ²
Dac	Vishay-Semiconductor	DF08SA	VF@Io= 1.1 V VRRM= 800.0 V	1	\$0.24	 DF-S 99 mm ²
Dsec	SMC Diode Solutions	SBRD10200TR	VF@Io= 950.0 mV VRRM= 200.0 V	1	\$0.12	 DPAK 102 mm ²
Dsec2	SMC Diode Solutions	SBRD10200TR	VF@Io= 950.0 mV VRRM= 200.0 V	1	\$0.12	 DPAK 102 mm ²
Dsnub	Microsemi	UFS180JE3/TR13	VF@Io= 1.2 V VRRM= 800.0 V	1	\$0.73	 DO-214BA 42 mm ²
Dz4	ON Semiconductor	MMBZ5244BLT1G	Zener	1	\$0.02	 SOT-23 14 mm ²
M1	STMicroelectronics	STD3NK80Z-1	VdsMax= 800.0 V IdsMax= 2.5 Amps	1	\$0.70	 IPAK 37 mm ²
M2	Infineon Technologies	BSP135H6327XTSA1	VdsMax= 600.0 V IdsMax= 120.0 mAmps	1	\$0.54	 SOT-223 76 mm ²
O1	Fairchild Semiconductor	FOD817A	Optocoupler	1	\$0.11	 DIP-4 71 mm ²
Rcs	Vishay-Dale	CRCW0402374RFKED Series= CRCW..e3	Res= 374.0 Ohm Power= 63.0 mW Tolerance= 1.0%	1	\$0.01	 0402 3 mm ²
Rdrv	Vishay-Dale	CRCW04024R75FKED Series= CRCW..e3	Res= 4.75 Ohm Power= 63.0 mW Tolerance= 1.0%	1	\$0.01	 0402 3 mm ²
Rfbb	Vishay-Dale	CRCW040214K7FKED Series= CRCW..e3	Res= 14.7 kOhm Power= 63.0 mW Tolerance= 1.0%	1	\$0.01	 0402 3 mm ²
Rfbt	Susumu Co Ltd	RR1220P-563-D Series= RR12	Res= 56.0 kOhm Power= 100.0 mW Tolerance= 0.5%	1	\$0.01	 0805 7 mm ²
Ropto	Yageo	RC0201FR-0710KL Series= ?	Res= 10.0 kOhm Power= 50.0 mW Tolerance= 1.0%	1	\$0.01	 0201 2 mm ²
Rqrb	Vishay-Dale	CRCW04027K87FKED Series= CRCW..e3	Res= 7.87 kOhm Power= 63.0 mW Tolerance= 1.0%	1	\$0.01	 0402 3 mm ²

Name	Manufacturer	Part Number	Properties	Qty	Price	Footprint
Rqrt	Yageo	RC0201FR-0723K7L Series= ?	Res= 23.7 kOhm Power= 50.0 mW Tolerance= 1.0%	1	\$0.01	0201 2 mm ²
Rsense	Rohm	MCR25JZHFLR430 Series= MCR25	Res= 430.0 mOhm Power= 500.0 mW Tolerance= 1.0%	1	\$0.03	1210 15 mm ²
Rsub1	Vishay-Dale	CRCW251249K9FKEG Series= CRCW..e3	Res= 49.9 kOhm Power= 1.0 W Tolerance= 1.0%	1	\$0.05	2512 43 mm ²
Rsub2	Vishay-Dale	CRCW251249K9FKEG Series= CRCW..e3	Res= 49.9 kOhm Power= 1.0 W Tolerance= 1.0%	1	\$0.05	2512 43 mm ²
Rvcc	Vishay-Dale	CRCW0402150RFKED Series= CRCW..e3	Res= 150.0 Ohm Power= 63.0 mW Tolerance= 1.0%	1	\$0.01	0402 3 mm ²
Rvin	Vishay-Bcomponents	PR03000201002JAC00 Series= ?	Res= 10.0 kOhm Power= 3.0 W Tolerance= 5.0%	1	\$0.17	PR03 197 mm ²
Rvsd	Vishay-Dale	CRCW08051M00FKEA Series= CRCW..e3	Res= 1000.0 kOhm Power= 125.0 mW Tolerance= 1.0%	1	\$0.01	0805 7 mm ²
T1	Core=TDK , CoilFormer=TDK	Core=B66319G0000X187 , CoilFormer=B66232J1112T001	Lp= 1.155 mH Turns Ratio(Nas)= 9:10 Turns Ratio(Nps)= 93:10 Npri= 93.0 Naux= 9.0 Nsec= 10.0	1	\$0.30	TDK_B66305 793 mm ²
U1	Texas Instruments	LM5023MMX-2/NOPB	Switcher	1	\$0.38	DGK0008A 24 mm ²
VR	Texas Instruments	TL431IDBVR	Voltage References	1	\$0.06	R-PDSO-G3 16 mm ²

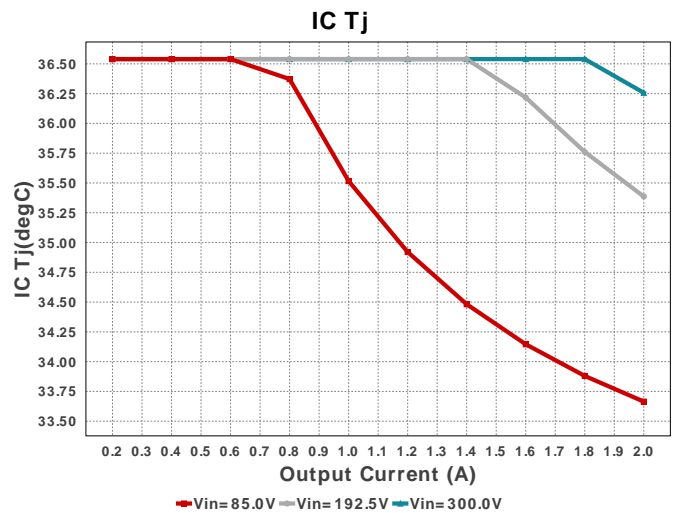
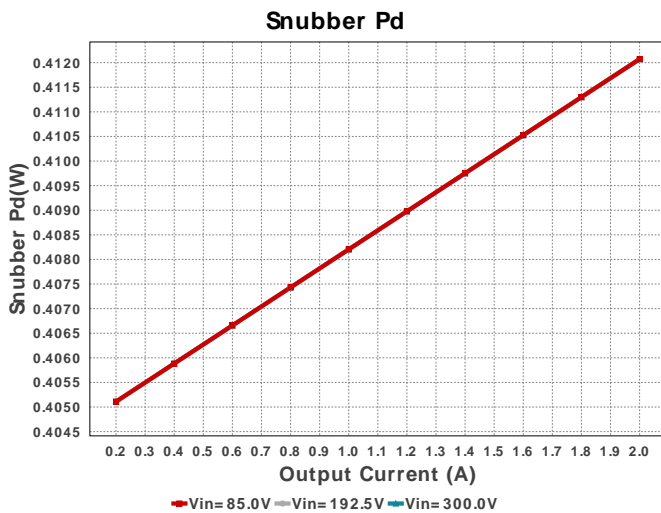

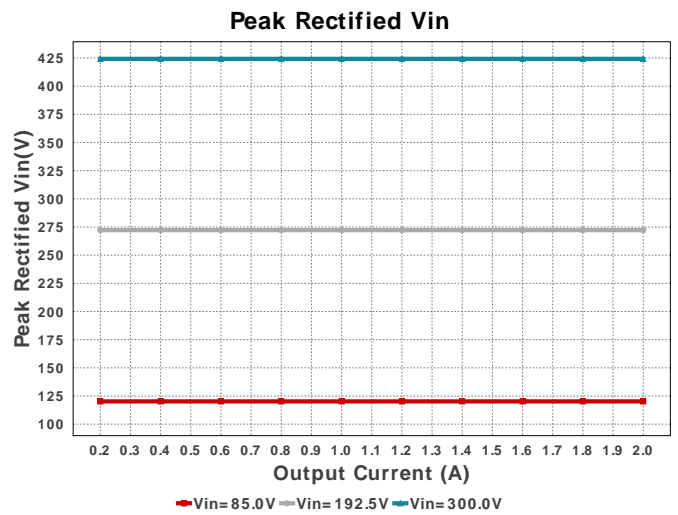
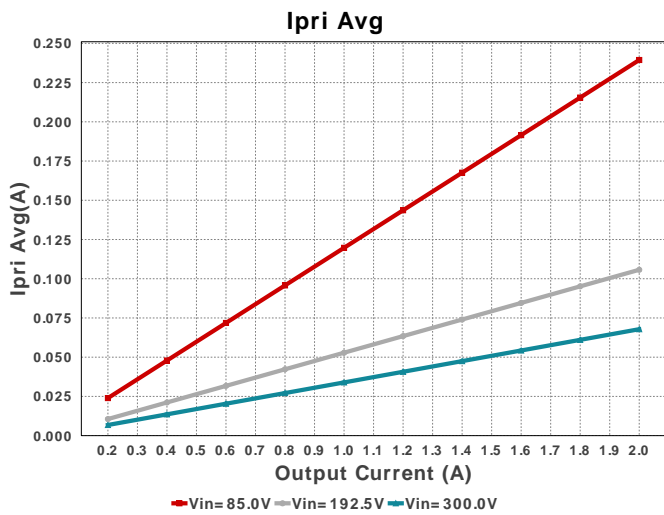
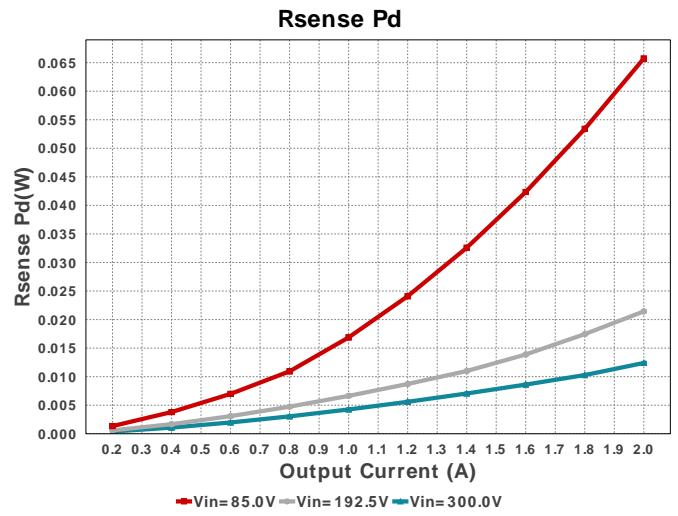
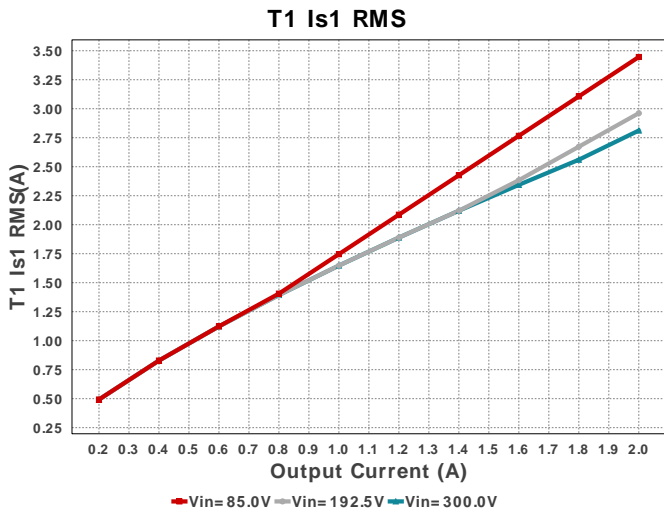
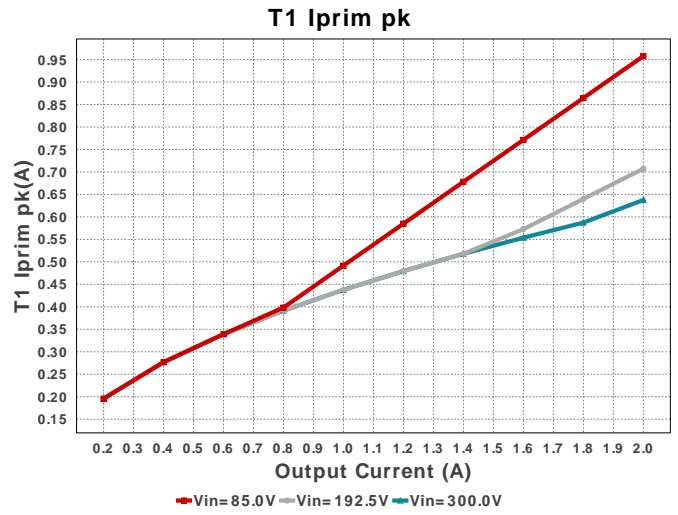
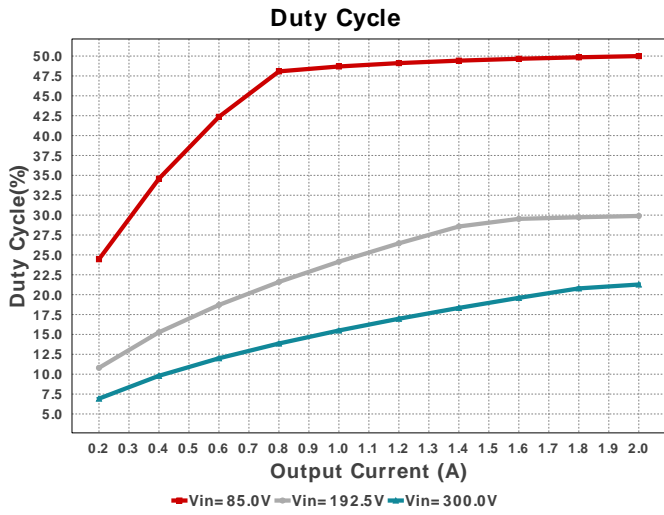

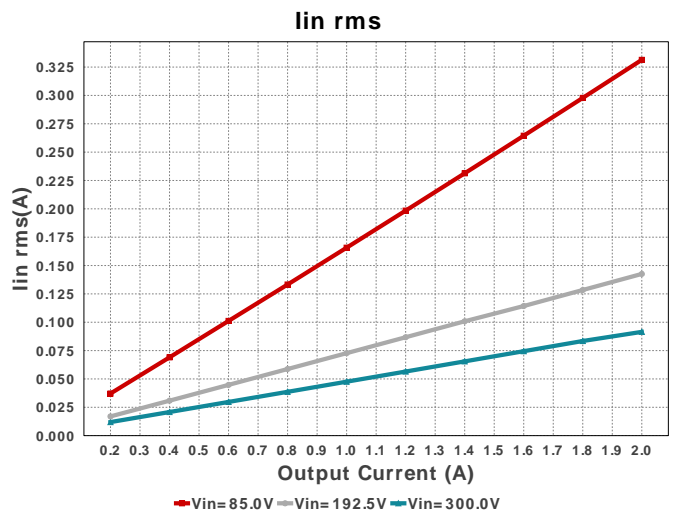
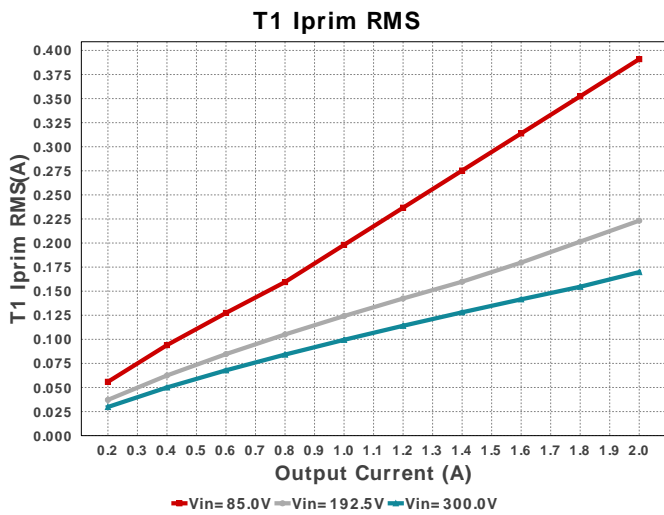
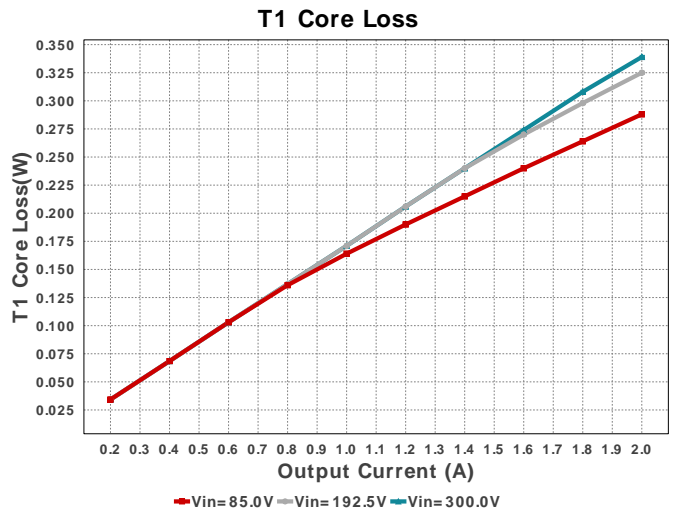
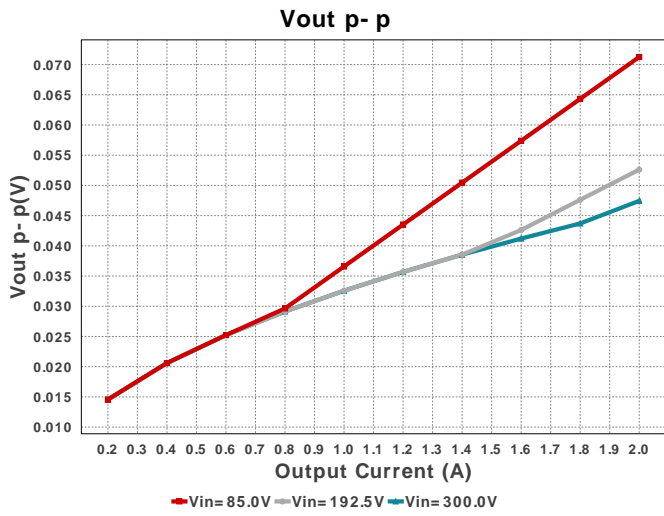
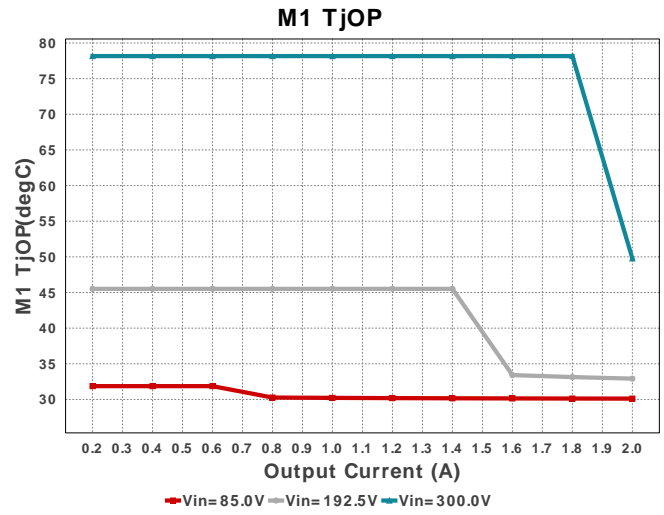
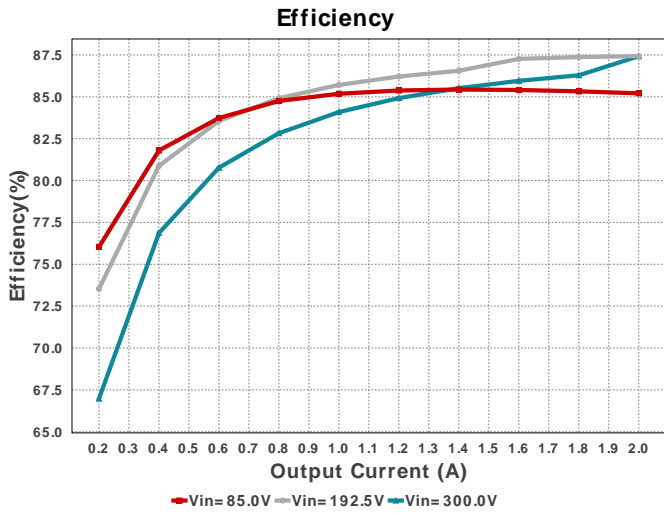

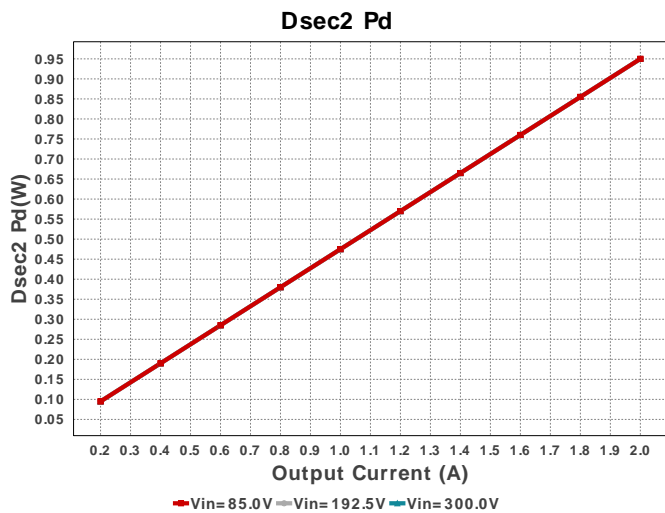
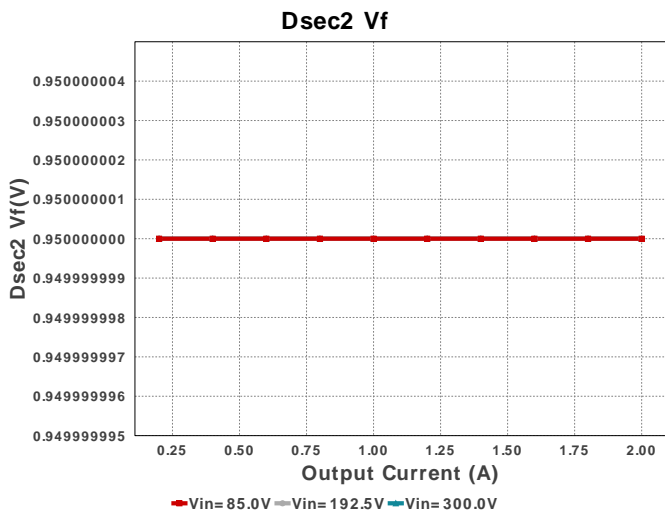
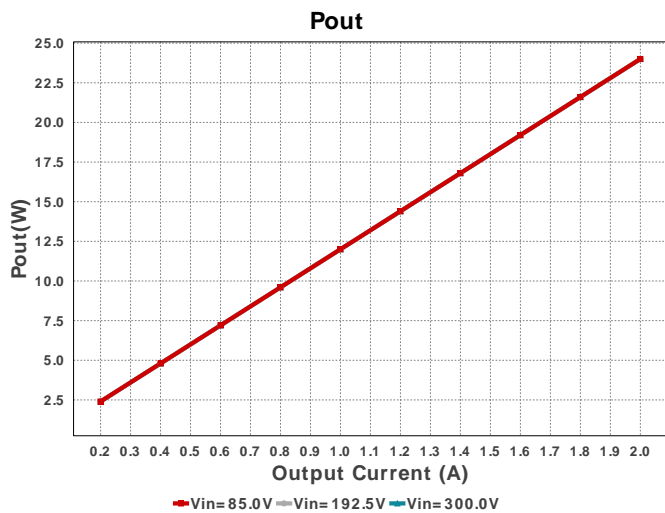
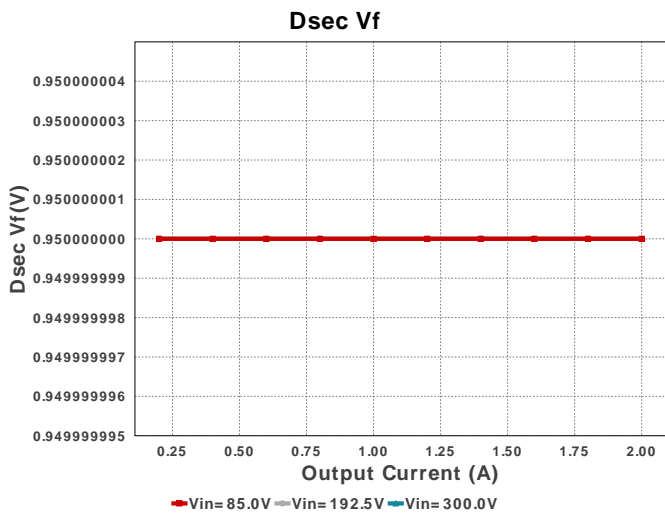
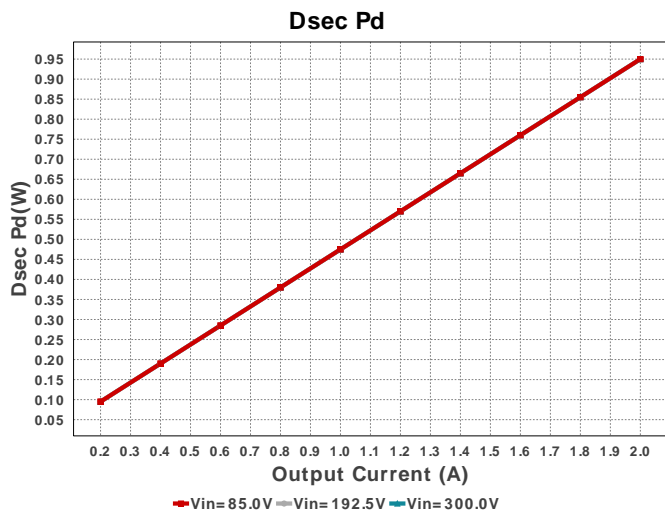
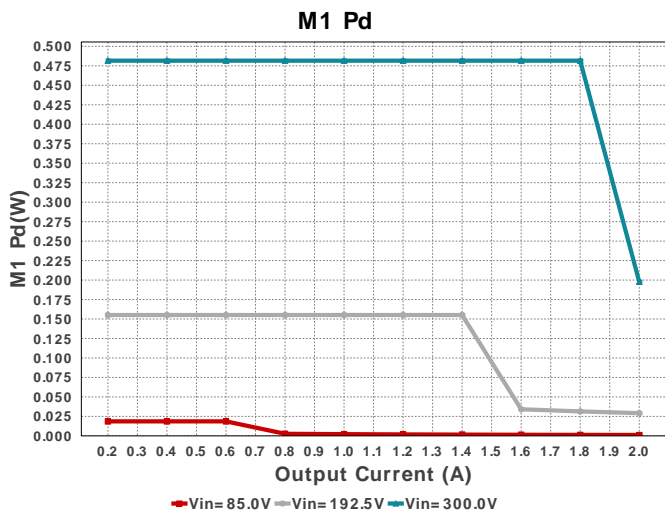

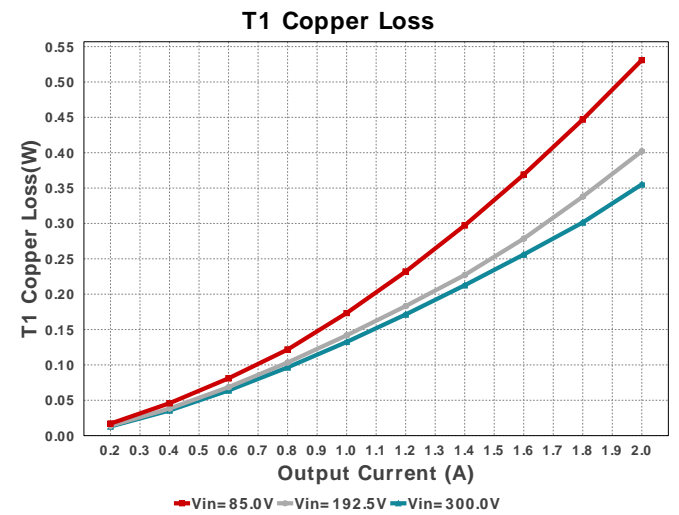
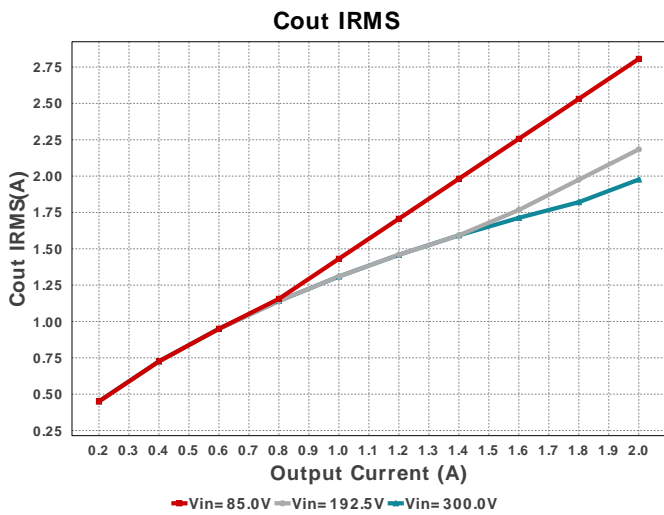
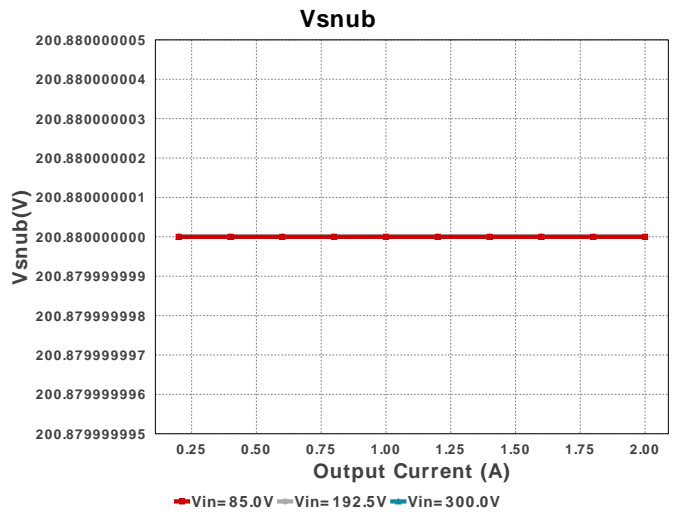
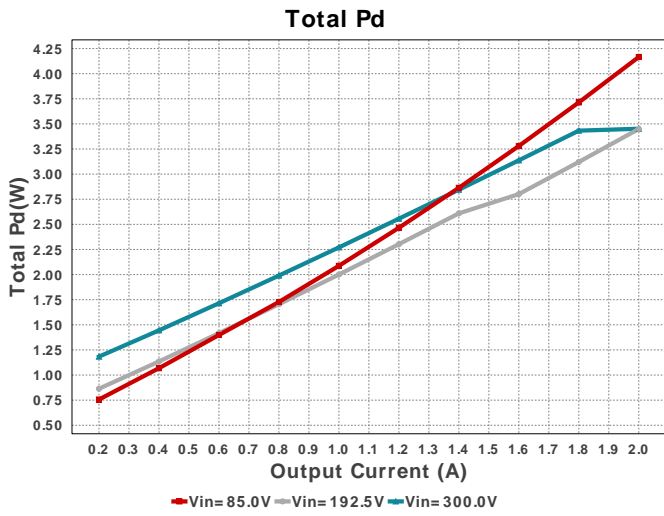
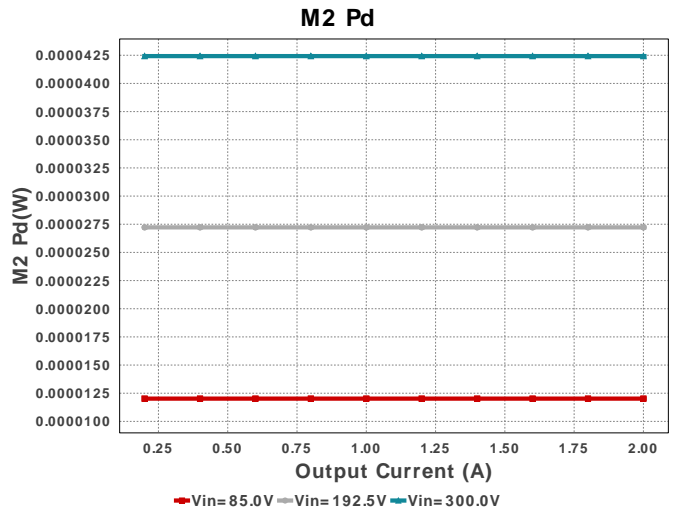
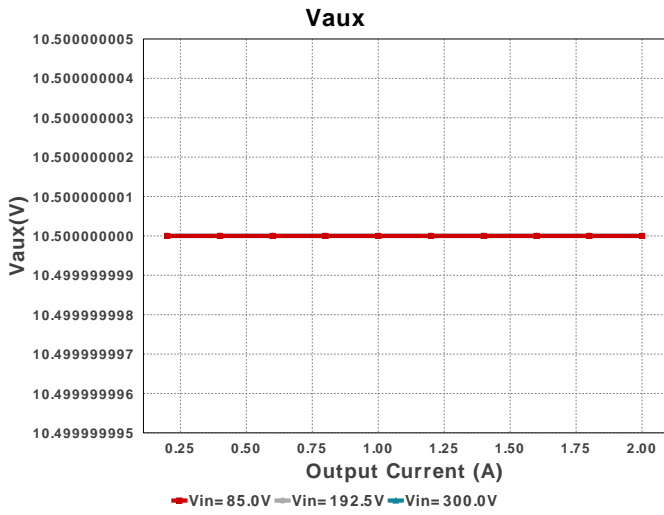

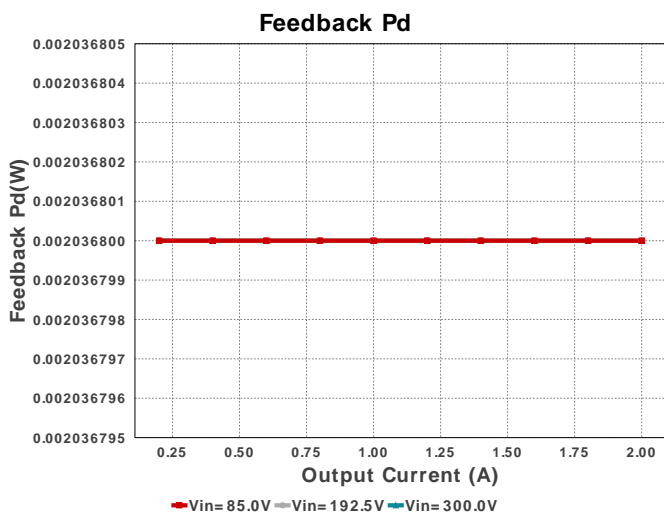
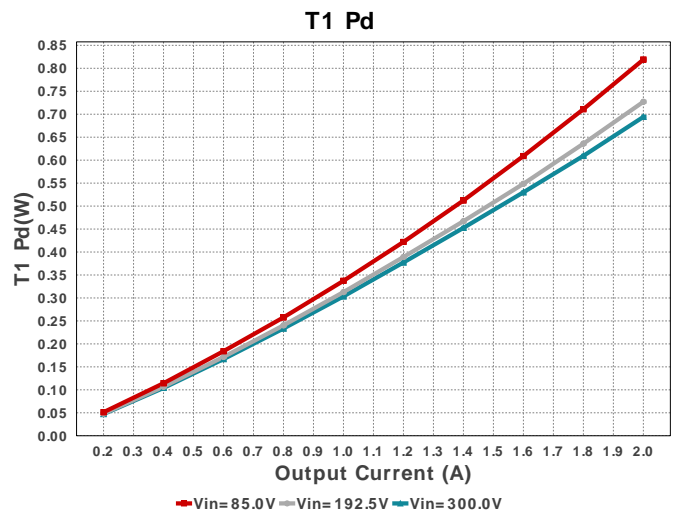
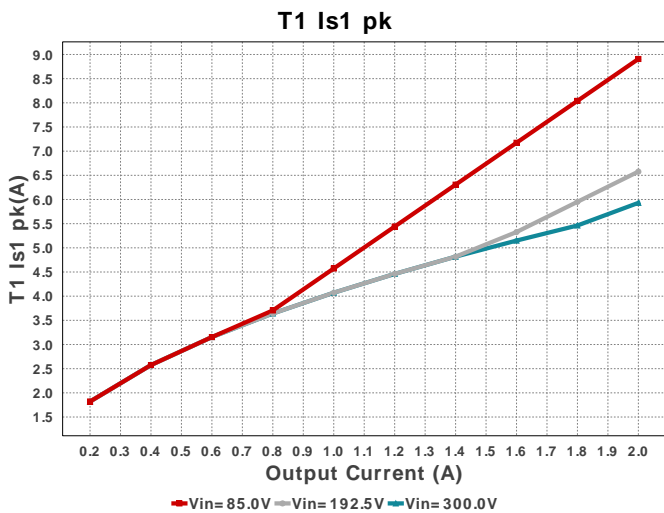
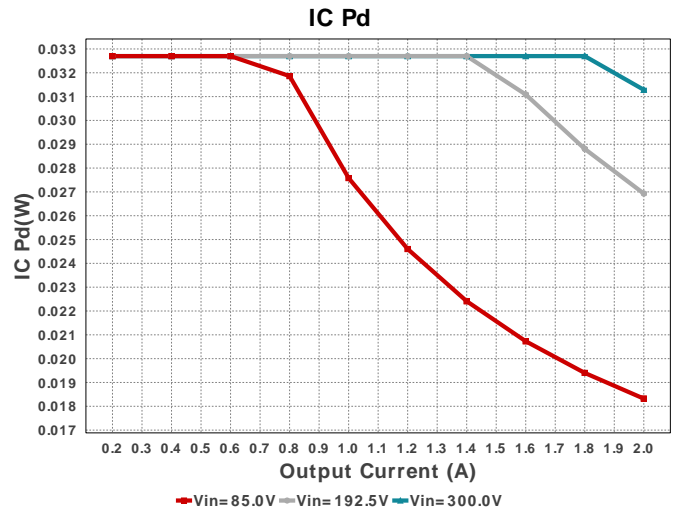
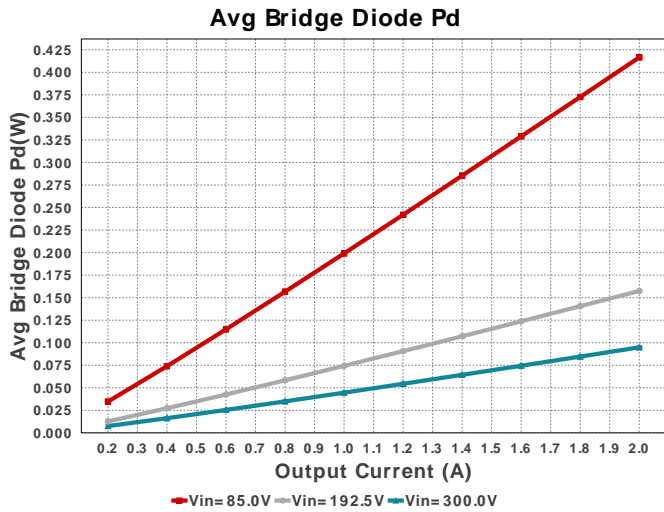

Operating Values

#	Name	Value	Category	Description
1.	Cout IRMS	2.806 A	Capacitor	Output capacitor RMS ripple current
2.	Avg Bridge Diode Pd	416.54 mW	Diode	Average Power Dissipation in the Bridge Diode over the AC Line Period
3.	Daux trr	35.0 ns	Diode	Auxiliary Diode Reverse Recovery Time
4.	Dsec Pd	950.0 mW	Diode	Secondary Diode Power Dissipation
5.	Dsec Vf	950.0 mV	Diode	Effective Forward Voltage Drop at the Operating Current
6.	Dsec trr	0.0 ns	Diode	Output Diode Reverse Recovery Time
7.	Dsec2 Pd	950.0 mW	Diode	Secondary Diode Power Dissipation
8.	Dsec2 Vf	950.0 mV	Diode	Effective Forward Voltage Drop at the Operating Current
9.	Dsnub trr	60.0 ns	Diode	Snubber Diode Reverse Recovery Time
10.	IC Pd	18.322 mW	IC	IC power dissipation
11.	IC Tj	33.664 degC	IC	IC junction temperature

#	Name	Value	Category	Description
12.	ICThetaJA	200.0 degC/W	IC	IC junction-to-ambient thermal resistance
13.	M1 Pd	898.79 mW	Mosfet	M1 MOSFET total power dissipation
14.	M1 TjOP	119.88 degC	Mosfet	M1 MOSFET junction temperature
15.	M2 Pd	12.021 μ W	Mosfet	M2 MOSFET total power dissipation
16.	Avg Bridge Diode Pd	416.54 mW	Power	Average Power Dissipation in the Bridge Diode over the AC Line Period
17.	Dsec Pd	950.0 mW	Power	Secondary Diode Power Dissipation
18.	Dsec2 Pd	950.0 mW	Power	Secondary Diode Power Dissipation
19.	Feedback Pd	2.037 mW	Power	Power Dissipation in Feedback Resistors
20.	IC Pd	18.322 mW	Power	IC power dissipation
21.	M1 Pd	898.79 mW	Power	M1 MOSFET total power dissipation
22.	M2 Pd	12.021 μ W	Power	M2 MOSFET total power dissipation
23.	Rsense Pd	65.727 mW	Power	LED Current Rsns Power Dissipation
24.	Snubber Pd	412.072 mW	Power	Snubber Power Dissipation
25.	T1 Copper Loss	515.6 mW	Power	Transformer Copper Loss Power Dissipation
26.	T1 Core Loss	515.6 mW	Power	Transformer Core Loss Power Dissipation
27.	T1 Pd	1.031 W	Power	Estimated Losses in Transformer
28.	Total Pd	5.277 W	Power	Total Power Dissipation
29.	Feedback Pd	2.037 mW	Resistor	Power Dissipation in Feedback Resistors
30.	Rsense Pd	65.727 mW	Resistor	LED Current Rsns Power Dissipation
31.	BOM Count	37	System	Total Design BOM count
32.	Duty Cycle	49.994 %	System Information	Duty cycle
33.	Efficiency	81.976 %	System Information	Steady state efficiency
34.	FootPrint	2.052 k mm ²	System Information	Total Foot Print Area of BOM components
35.	Frequency	54.328 kHz	System Information	Switching frequency
36.	Iin rms	344.43 mA	System Information	RMS Input Current
37.	Iout	2.0 A	System Information	Iout operating point
38.	Mode	TM	System Information	Conduction Mode
39.	Peak Rectified Vin	120.207 V	System Information	Peak voltage seen at rectified input
40.	Pout	24.0 W	System Information	Total output power
41.	Total BOM	NA	System Information	Total BOM Cost
42.	Vin_RMS	85.0 V	System Information	Vin operating point
43.	Vout	12.0 V	System Information	Operational Output Voltage
44.	Vout Actual	12.0 V	System Information	Vout Actual calculated based on selected voltage divider resistors
45.	Vout Tolerance	1.525 %	System Information	Vout Tolerance based on IC Tolerance (no load) and voltage divider resistors if applicable
46.	Vout p-p	71.255 mV	System Information	Peak-to-peak output ripple voltage
47.	Vsnub	200.88 V	System Information	Voltage Across the Snubber
48.	Ipri Avg	239.402 mA	Transformer	Average Current in Primary Winding over the complete Switching Period
49.	T1 Copper Loss	515.6 mW	Transformer	Transformer Copper Loss Power Dissipation
50.	T1 Core Loss	515.6 mW	Transformer	Transformer Core Loss Power Dissipation
51.	T1 Iprim RMS	390.966 mA	Transformer	Transformer Primary RMS Current
52.	T1 Iprim pk	957.727 mA	Transformer	Transformer Primary Peak Current
53.	T1 Is1 RMS	3.446 A	Transformer	Transformer Secondary1 RMS Current
54.	T1 Is1 pk	8.907 A	Transformer	Transformer Secondary1 Peak Current
55.	T1 Pd	1.031 W	Transformer	Estimated Losses in Transformer
56.	Vaux	10.5 V	Transformer	Auxiliary Voltage

Design Inputs

Name	Value	Description
Iout	2.0	Maximum Output Current
VinMax	300.0	Maximum input voltage
VinMin	85.0	Minimum input voltage
Vout	12.0	Output Voltage
acFrequency	60.0	AC Frequency
base_pn	LM5023	Base Product Number
source	AC	Input Source Type
Ta	30.0	Ambient temperature

WEBENCH® Assembly

Component Testing

Some published data on components in datasheets such as Capacitor ESR and Inductor DC resistance is based on conservative values that will guarantee that the components always exceed the specification. For design purposes it is usually better to work with typical values. Since this data is not always available it is a good practice to measure the Capacitance and ESR values of C_{in} and C_{out} , and the inductance and DC resistance of $L1$ before assembly of the board. Any large discrepancies in values should be electrically simulated in WEBENCH to check for instabilities and thermally simulated in WebTHERM to make sure critical temperatures are not exceeded.

Soldering Component to Board

If board assembly is done in house it is best to tack down one terminal of a component on the board then solder the other terminal. For surface mount parts with large tabs, such as the DPAK, the tab on the back of the package should be pre-tinned with solder, then tacked into place by one of the pins. To solder the tab down to the board place the iron down on the board while resting against the tab, heating both surfaces simultaneously. Apply light pressure to the top of the plastic case until the solder flows around the part and the part is flush with the PCB. If the solder is not flowing around the board you may need a higher wattage iron (generally 25W to 30W is enough).

Initial Startup of Circuit

It is best to initially power up the board by setting the input supply voltage to the lowest operating input voltage 85.0V and set the input supply's current limit to zero. With the input supply off connect up the input supply to V_{in} and GND. Connect a digital volt meter and a load if needed to set the minimum load of the design from V_{out} and GND. Turn on the input supply and slowly turn up the current limit on the input supply. If the voltage starts to rise on the input supply continue increasing the input supply current limit while watching the output voltage. If the current increases on the input supply, but the voltage remains near zero, then there may be a short or a component misplaced on the board. Power down the board and visually inspect for solder bridges and recheck the diode and capacitor polarities. Once the power supply circuit is operational then more extensive testing may include full load testing, transient load and line tests to compare with simulation results.

Load Testing

The setup is the same as the initial startup, except that an additional digital voltmeter is connected between V_{in} and GND, a load is connected between V_{out} and GND and a current meter is connected in series between V_{out} and the load. The load must be able to handle at least rated output power + 50% (7.5 watts for this design). Ideally the load is supplied in the form of a variable load test unit. It can also be done in the form of suitably large power resistors. When using an oscilloscope to measure waveforms on the prototype board, the ground leads of the oscilloscope probes should be as short as possible and the area of the loop formed by the ground lead should be kept to a minimum. This will help reduce ground lead inductance and eliminate EMI noise that is not actually present in the circuit.

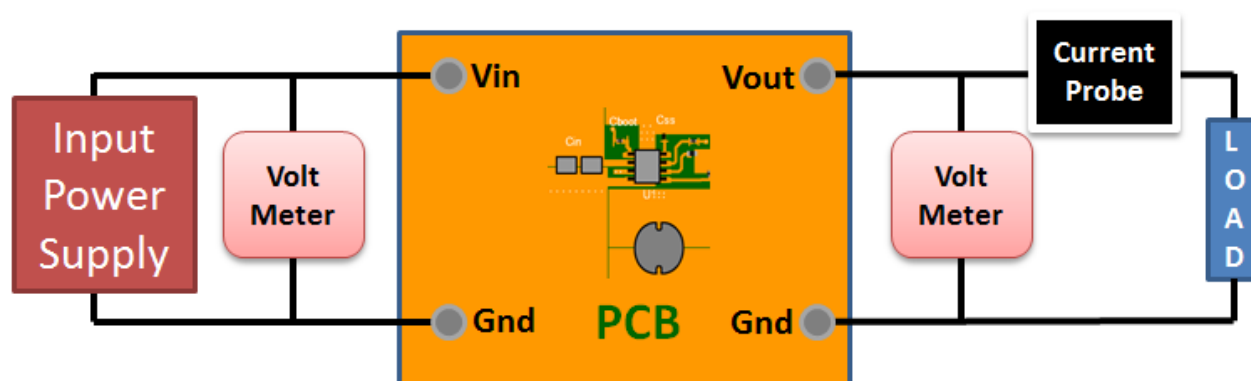

WEBENCH® Transformer Report

#	Name	Value
1.	Core Part Number	B66319G0000X187
2.	Core Manufacturer	TDK
3.	Coil Former Part Number	B66232J1112T001
4.	Coil Former Manufacturer	TDK

Transformer Electrical Diagram

Primary

Turns	93.0
AWG	23.0
Layers	4.0
Strands	1.0
Insulation Type	Heavy Insulated Magnet Wire

Auxiliary

Turns	9.0
AWG	28.0
Layers	1.0
Strands	4.0
Insulation Type	Heavy Insulated Magnet Wire

Secondary

Turns	10.0
AWG	25.0
Layers	1.0
Strands	2.0
Insulation Type	Triple Insulated

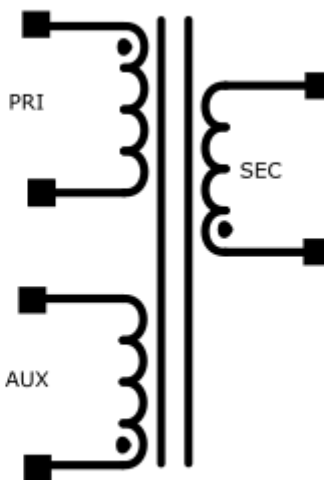

Transformer Construction Diagram

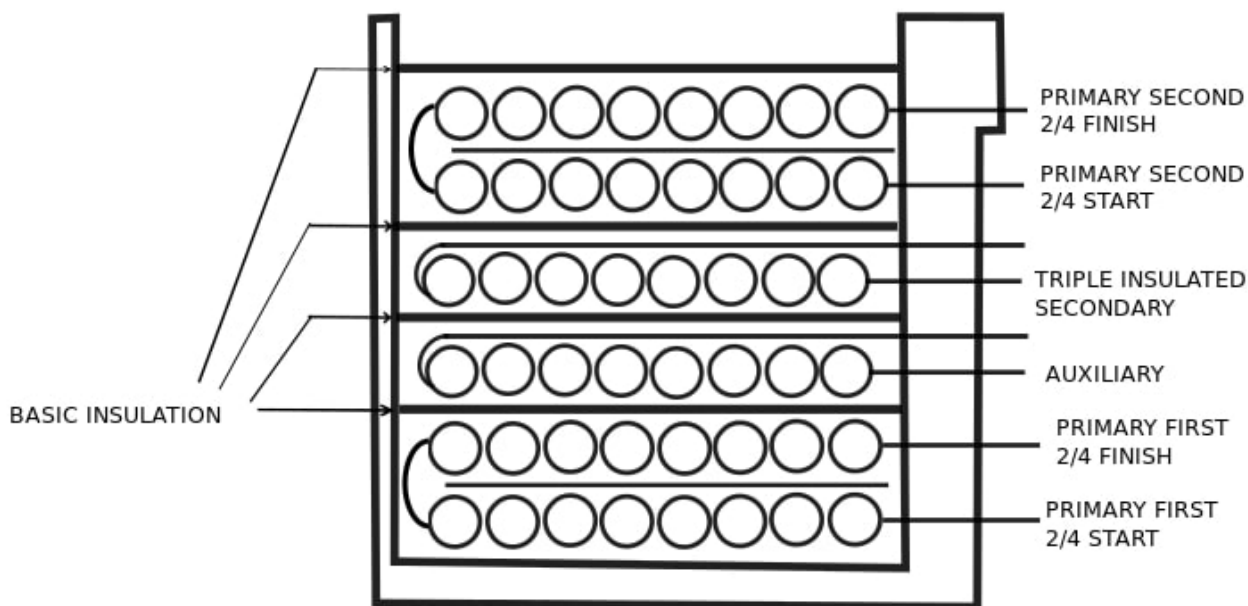

Winding Instruction

Winding	AWG	Turns	Winding Orientation
Primary First 2/4.0	23.0	47	Clockwise
Auxiliary	28.0	9.0	Counter Clockwise
Triple Insulated Secondary	25.0	10.0	Counter Clockwise
Primary Second 2/4.0	23.0	46	Clockwise

Transformer Parameters

#	Name	Value
1.	Lpri	0.00115H
2.	Inductance Factor(AI)	134.0nH
3.	Npri	93.0
4.	Nsec	10.0
5.	Naux	9.0
6.	Core Type	E30/15/7
7.	Core Material	N87
8.	Bmax	0.20T
9.	Switching Frequency	50.00kHz
10.	DMax	0.45
11.	Ipk(Primary)	0.96A
12.	Irms(Primary)	0.37A
13.	Ipk(Secondary)	8.94A
14.	Irms(Secondary)	3.49A

Design Assistance

1. Master key : 86754C272394AD58[v1]
2. **LM5023** Product Folder : <http://www.ti.com/product/LM5023> : contains the data sheet and other resources.

Important Notice and Disclaimer

TI provides technical and reliability data (including datasheets), design resources (including reference designs), application or other design advice, web tools, safety information, and other resources AS IS and with all faults, and disclaims all warranties. These resources are intended for skilled developers designing with TI products. You are solely responsible for (1) selecting the appropriate TI products for your application, (2) designing, validating and testing your application, and (3) ensuring your application meets applicable standards, and any other safety, security, or other requirements.

These resources are subject to change without notice. TI grants you permission to use these resources only for development of an application that uses the TI products described in the resource. Other reproduction and display of these resources is prohibited. No license is granted to any other TI intellectual property right or to any third party intellectual property right. TI disclaims responsibility for, and you will fully indemnify TI and its representatives against, any claims, damages, costs, losses, and liabilities arising out of your use of these resources.

Providing these resources does not expand or otherwise alter TI's applicable Terms of Sale or other applicable terms available either on ti.com or provided in conjunction with TI products.