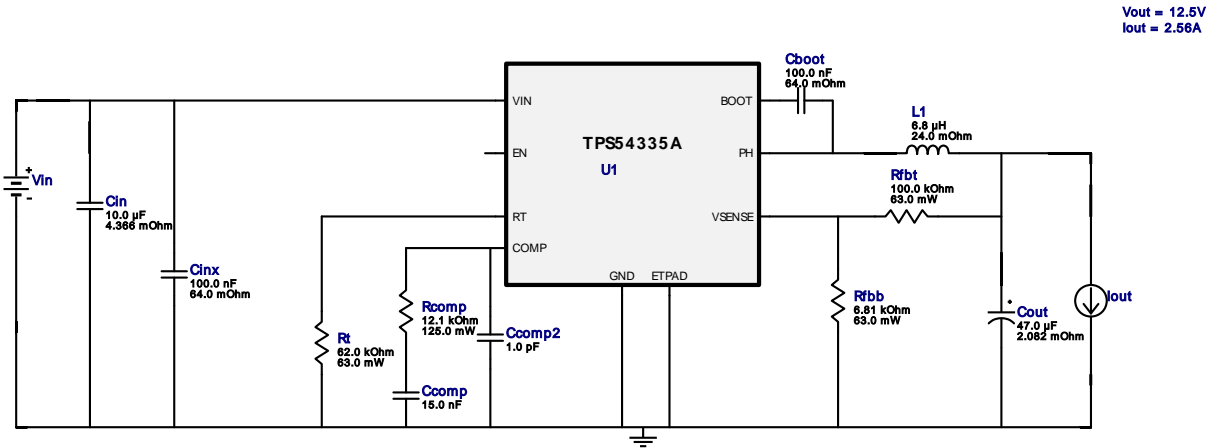
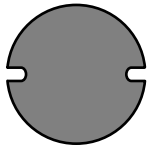

**WEBENCH<sup>®</sup> Design Report**

 Design : 3456224/1585 TPS54335ADDAR  
 TPS54335ADDAR 16.7V-16.9V to 12.50V @ 2.56A

**My Comments**  
 No comments

**Electrical BOM**

#	Name	Manufacturer	Part Number	Properties	Qty	Price	Footprint
1.	Cboot	Kemet	C0805C104K5RACTU Series= X7R	Cap= 100.0 nF ESR= 64.0 mOhm VDC= 50.0 V IRMS= 1.64 A	1	\$0.01	0805 7 mm <sup>2</sup>
2.	Ccomp	Yageo America	CC0805KRX7R9BB153 Series= X7R	Cap= 15.0 nF VDC= 50.0 V IRMS= 0.0 A	1	\$0.01	0805 7 mm <sup>2</sup>
3.	Ccomp2	MuRata	GRM1555C1H1ROCA01D Series= COG/NPO	Cap= 1.0 pF VDC= 50.0 V IRMS= 0.0 A	1	\$0.01	0402 3 mm <sup>2</sup>
4.	Cin	MuRata	GRM31CR71E106KA12L Series= X7R	Cap= 10.0 uF ESR= 4.366 mOhm VDC= 25.0 V IRMS= 2.8022 A	1	\$0.05	1206_190 11 mm <sup>2</sup>
5.	Cinx	Kemet	C0805C104K5RACTU Series= X7R	Cap= 100.0 nF ESR= 64.0 mOhm VDC= 50.0 V IRMS= 1.64 A	1	\$0.01	0805 7 mm <sup>2</sup>
6.	Cout	TDK	C3216X5R1E476M160AC Series= X5R	Cap= 47.0 uF ESR= 2.082 mOhm VDC= 25.0 V IRMS= 5.0279 A	1	\$0.35	1206 11 mm <sup>2</sup>
7.	L1	CUSTOM	CUSTOM_INDUCTOR_MD	L= 6.8 uH DCR= 24.0 mOhm	1	\$0.10	 SDR1307 170 mm <sup>2</sup>
8.	Rcomp	Panasonic	ERJ-6ENF1212V Series= ERJ-6E	Res= 12.1 kOhm Power= 125.0 mW Tolerance= 1.0%	1	\$0.01	0805 7 mm <sup>2</sup>

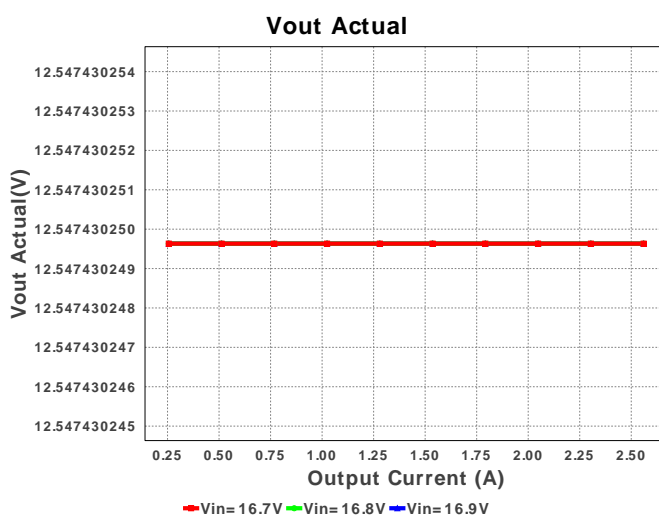
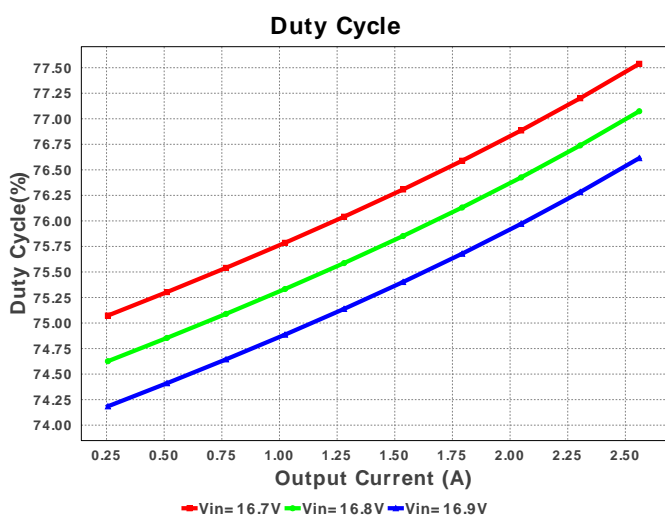
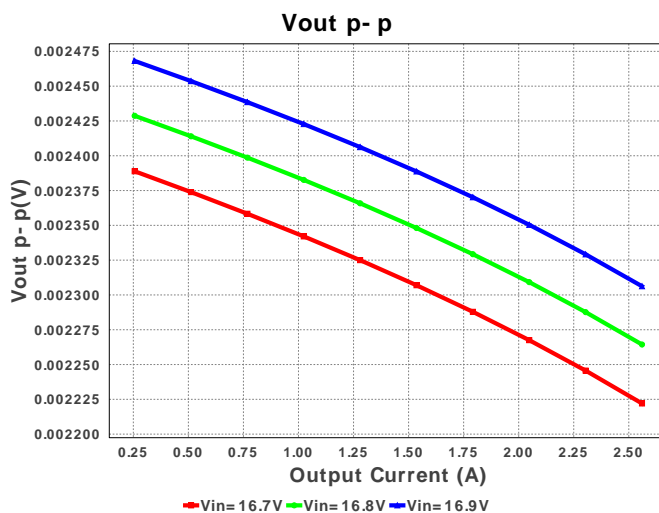
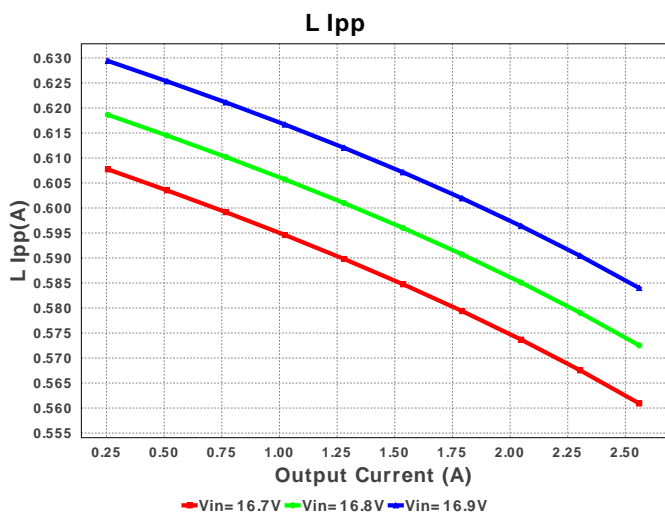
#	Name	Manufacturer	Part Number	Properties	Qty	Price	Footprint
9.	Rfbb	Vishay-Dale	CRCW04026K81FKED Series= CRCW...e3	Res= 6.81 kOhm Power= 63.0 mW Tolerance= 1.0%	1	\$0.01	0402 3 mm <sup>2</sup>
10.	Rfbt	Vishay-Dale	CRCW0402100KFKED Series= CRCW...e3	Res= 100.0 kOhm Power= 63.0 mW Tolerance= 1.0%	1	\$0.01	0402 3 mm <sup>2</sup>
11.	Rt	CUSTOM	CUSTOM_RESISTOR_MD Series= CUSTOM	Res= 62.0 kOhm Power= 63.0 mW Tolerance= 1.0%	1	\$0.10	0805 1 mm <sup>2</sup>
12.	U1	Texas Instruments	TPS54335ADDAR	Switcher	1	\$0.90	R-PDS0-G8 55 mm <sup>2</sup>

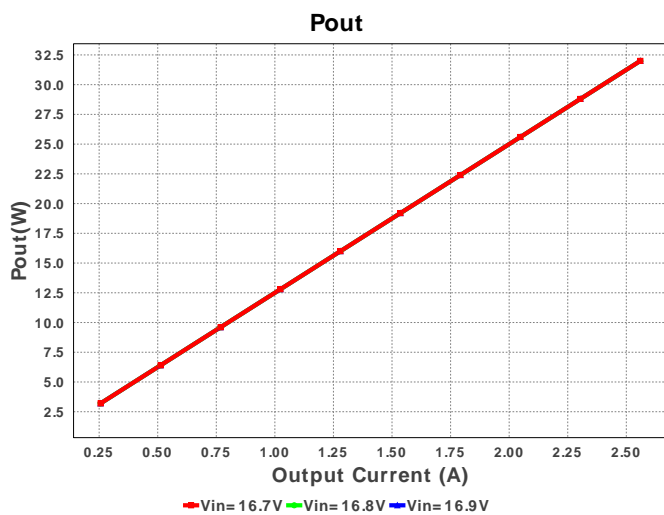
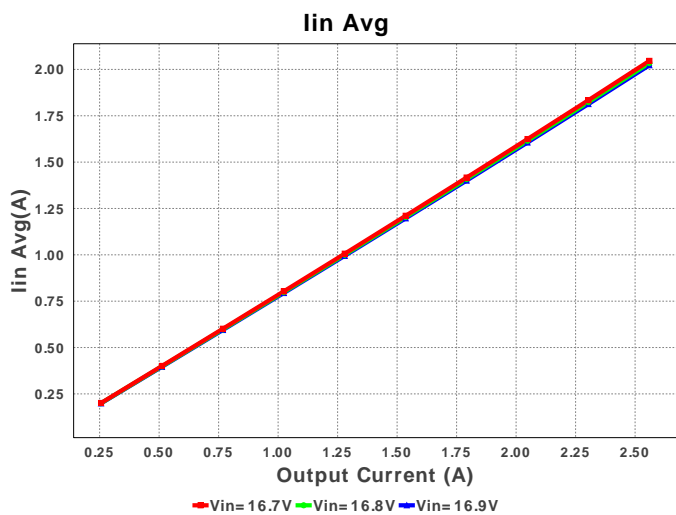
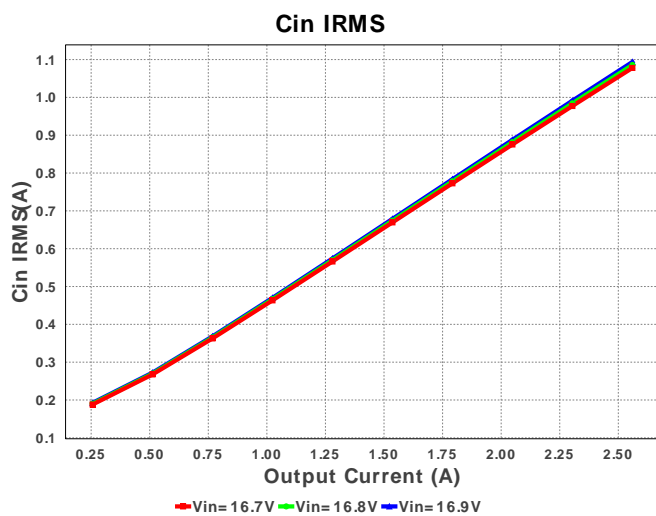
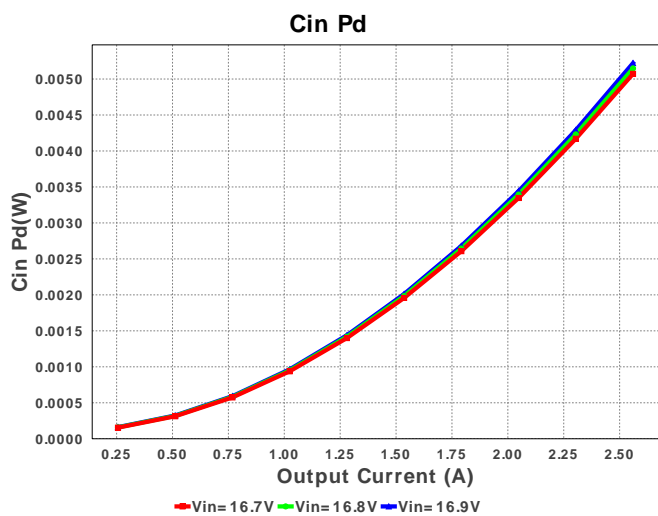
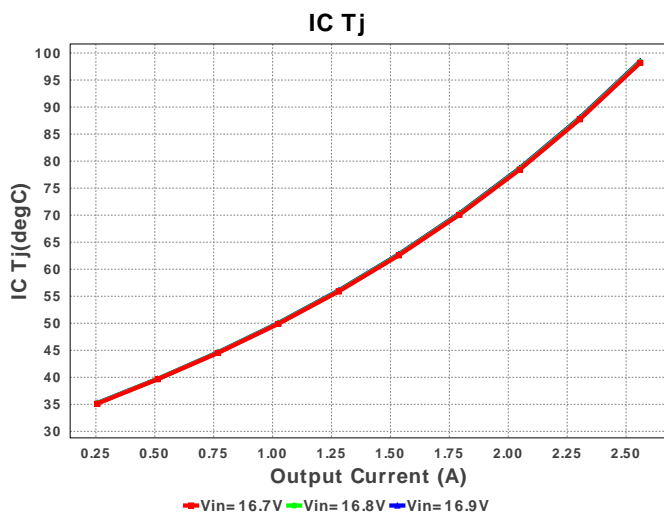
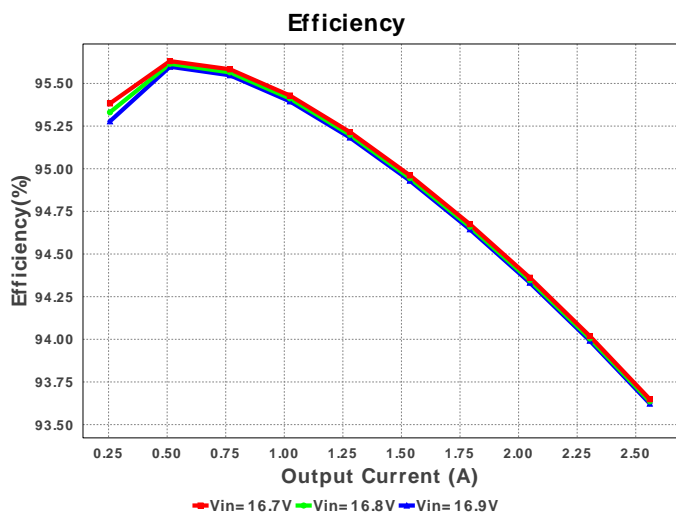



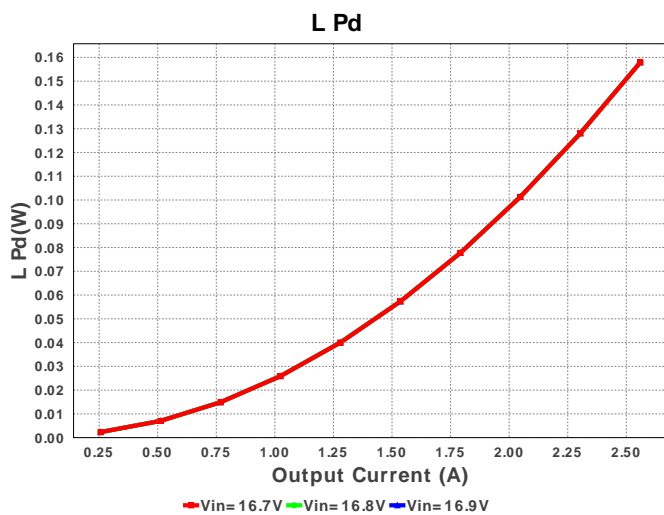
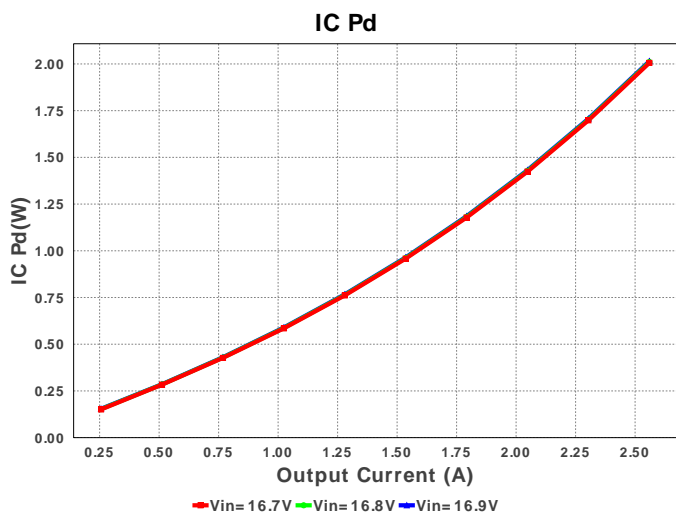
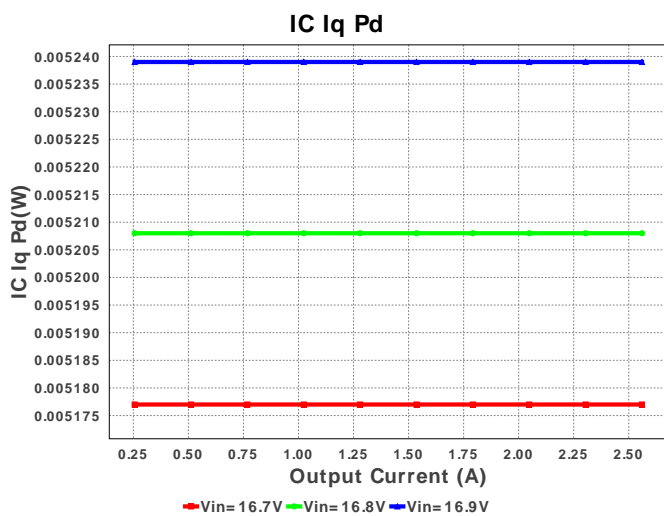
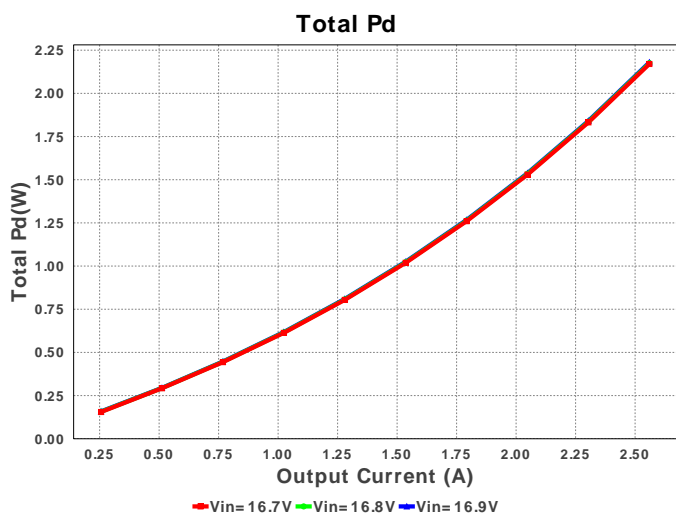
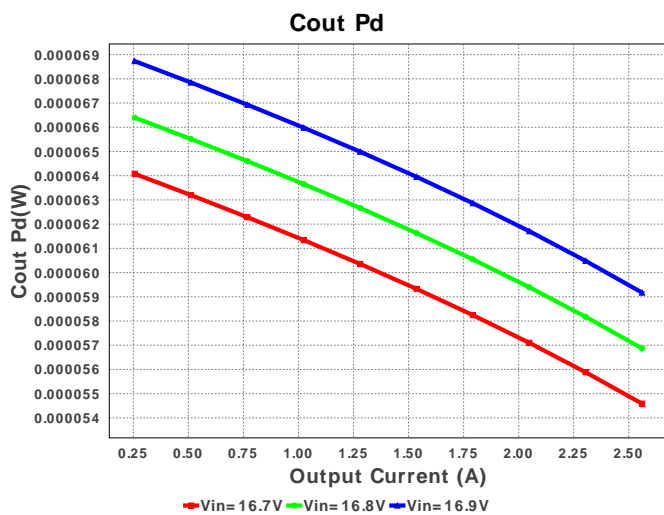
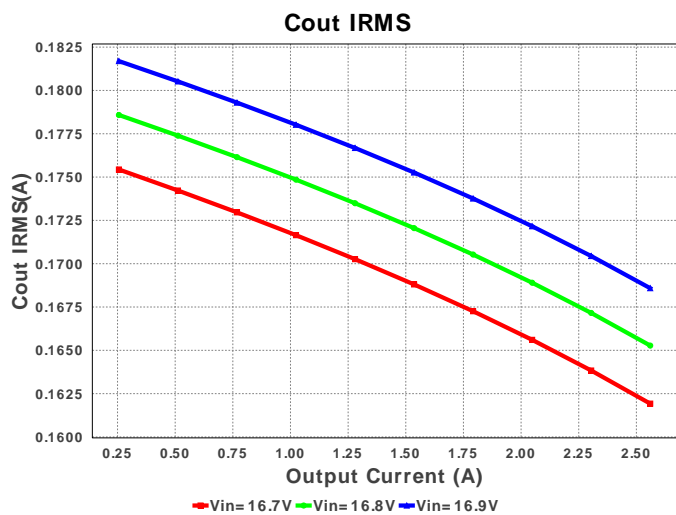

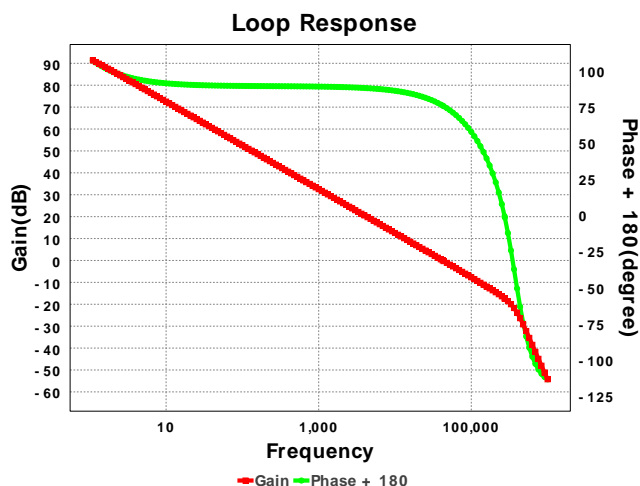

## Operating Values

#	Name	Value	Category	Description
1.	BOM Count	12		Total Design BOM count
2.	Total BOM	\$1.57		Total BOM Cost
3.	Cin IRMS	1.094 A	Current	Input capacitor RMS ripple current
4.	Cout IRMS	168.586 mA	Current	Output capacitor RMS ripple current
5.	Iin Avg	2.022 A	Current	Average input current
6.	L Ipp	583.998 mA	Current	Peak-to-peak inductor ripple current
7.	FootPrint	343.0 mm <sup>2</sup>	General	Total Foot Print Area of BOM components
8.	Frequency	755.683 kHz	General	Switching frequency
9.	IC Tolerance	12.0 mV	General	IC Feedback Tolerance
10.	Mode	CCM	General	Conduction Mode
11.	Pout	32.0 W	General	Total output power
12.	ICThetaJA Effective	34.0 degC/W	Op_Point	Effective IC Junction-to-Ambient Thermal Resistance
13.	Low Freq Gain	91.31 dB	Op_Point	Gain at 10Hz
14.	Vout Actual	12.547 V	Op_Point	Vout Actual calculated based on selected voltage divider resistors
15.	Vout OP	12.5 V	Op_Point	Operational Output Voltage
16.	Cross Freq	42.215 kHz	Op_point	Bode plot crossover frequency
17.	Duty Cycle	76.615 %	Op_point	Duty cycle
18.	Efficiency	93.623 %	Op_point	Steady state efficiency
19.	Gain Marg	-17.305 dB	Op_point	Bode Plot Gain Margin
20.	IC Tj	98.507 degC	Op_point	IC junction temperature
21.	IOUT_OP	2.56 A	Op_point	Iout operating point
22.	Phase Marg	76.563 deg	Op_point	Bode Plot Phase Margin
23.	VIN_OP	16.9 V	Op_point	Vin operating point
24.	Vout p-p	2.306 mV	Op_point	Peak-to-peak output ripple voltage
25.	Cin Pd	5.222 mW	Power	Input capacitor power dissipation
26.	Cout Pd	59.173 μW	Power	Output capacitor power dissipation
27.	IC Iq Pd	5.239 mW	Power	IC Iq Pd
28.	IC Pd	2.015 W	Power	IC power dissipation
29.	L Pd	157.969 mW	Power	Inductor power dissipation
30.	Total Pd	2.18 W	Power	Total Power Dissipation
31.	Vout Tolerance	3.42 %		Vout Tolerance based on IC Tolerance (no load) and voltage divider resistors if applicable

## Design Inputs

#	Name	Value	Description
1.	Iout	2.56	Maximum Output Current
2.	VinMax	16.9	Maximum input voltage
3.	VinMin	16.7	Minimum input voltage
4.	Vout	12.5	Output Voltage
5.	base_pn	TPS54335A	Texas Instruments Base Part Number
6.	source	DC	Input Source Type
7.	ta	30.0	Ambient temperature

## Design Assistance

1. TPS54335A Product Folder : <http://www.ti.com/product/TPS54335A> : contains the data sheet and other resources.

Texas Instruments' WEBENCH simulation tools attempt to recreate the performance of a substantially equivalent physical implementation of the design. Simulations are created using Texas Instruments' published specifications as well as the published specifications of other device manufacturers. While Texas Instruments does update this information periodically, this information may not be current at the time the simulation is built. Texas Instruments does not warrant the accuracy or completeness of the specifications or any information contained therein. Texas Instruments does not warrant that any designs or recommended parts will meet the specifications you entered, will be suitable for your application or fit for any particular purpose, or will operate as shown in the simulation in a physical implementation. Texas Instruments does not warrant that the designs are production worthy.

**You should completely validate and test your design implementation to confirm the system functionality for your application prior to production.**

Use of Texas Instruments' WEBENCH simulation tools is subject to [Texas Instruments' Site Terms and Conditions of Use](#). Prototype boards based on WEBENCH created designs are provided AS IS without warranty of any kind for evaluation and testing purposes and are subject to the terms of the [Evaluation License Agreement](#).