

# Shielded Power Inductors - SER2900

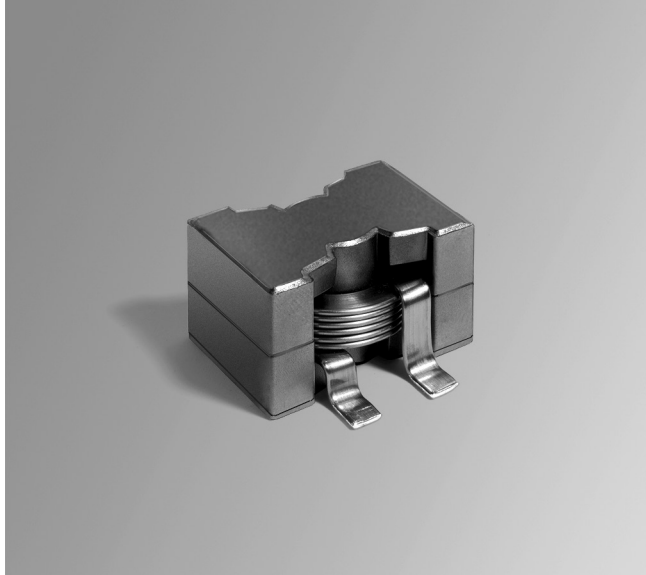

- Same electrical specifications as Coilcraft's SER2800
- Extremely low DCR; Current handling to >100 Amps
- Third mounting pad for greater stability and board adhesion

**Core material** Ferrite

**Core and winding loss** See [www.coilcraft.com/coreloss](http://www.coilcraft.com/coreloss)

**Terminations** Leads: RoHS compliant tin-silver over copper

Base pad: RoHS compliant gold over nickel over phos bronze

Other terminations available at additional cost.

**Weight** SER2915L–28.5g; SER2915H–29.7g; SER2918H–35.7g

**Ambient temperature** –40°C to +85°C with (40°C rise) Irms current.

**Maximum part temperature** +125°C (ambient + temp rise). [Derating](#).

**Storage temperature** Component: –40°C to +125°C.

Tape and reel packaging: –40°C to +80°C

**Resistance to soldering heat** Max three 40 second reflows at +260°C, parts cooled to room temperature between cycles

**Moisture Sensitivity Level (MSL)** 1 (unlimited floor life at <30°C / 85% relative humidity)

**Failures in Time (FIT) / Mean Time Between Failures (MTBF)**

38 per billion hours / 26,315,789 hours, calculated per Telcordia SR-332

**Packaging** 25 pieces per tray

**PCB washing** Tested to MIL-STD-202 Method 215 plus an additional aqueous wash. See [Doc787\\_PCB\\_Washing.pdf](#).

Part number <sup>1</sup>	Inductance <sup>2</sup> ±10% (µH)	DCR <sup>3</sup> (mOhms)		SRF typ <sup>4</sup> (MHz)	Isat (A) <sup>5</sup>			Irms (A) <sup>6</sup>	
		nom	max		10% drop	20% drop	30% drop	20°C rise	40°C rise
SER2915L-152KL	1.5	1.50	1.65	60	100	>100	>100	20	30
SER2915H-222KL	2.2	1.86	2.05	40	100	>100	>100	20	30
SER2915L-222KL	2.2	1.50	1.65	50	82.0	84.0	84.8	20	30
SER2918H-332KL	3.3	2.60	2.86	40	91.0	92.5	93.6	20	28
SER2915H-332KL	3.3	1.86	2.05	30	62.0	66.9	68.4	20	30
SER2915L-332KL	3.3	1.50	1.65	40	48.0	54.0	57.0	20	30
SER2918H-472KL	4.7	2.60	2.86	30	59.0	61.2	62.4	20	28
SER2915H-472KL	4.7	1.86	2.05	25	42.0	48.0	50.1	20	30
SER2915L-472KL	4.7	1.50	1.65	30	33.0	36.9	39.0	20	30
SER2918H-682KL	6.8	2.60	2.86	25	42.0	45.0	45.9	20	28
SER2915H-682KL	6.8	1.86	2.05	20	30.0	34.5	36.2	20	30
SER2915L-682KL	6.8	1.50	1.65	25	22.0	26.0	27.8	20	30
SER2918H-103KL	10	2.60	2.86	20	28.0	31.2	32.1	20	28
SER2915H-103KL	10	1.86	2.05	15	18.0	21.5	23.4	20	30
SER2915L-103KL	10	1.50	1.65	20	13.0	16.2	17.6	20	30
SER2918H-153KL	15	2.60	2.86	16	18.0	21.2	21.9	20	28
SER2915H-153KL	15	1.86	2.05	12	11.5	14.0	15.2	20	30
SER2915L-153KL	15	1.50	1.65	15	7.5	9.8	11.0	20	30
SER2918H-223KL	22	2.60	2.86	15	12.0	14.0	15.0	20	28
SER2915H-223KL	22	1.86	2.05	10	7.0	8.6	9.6	20	30
SER2915L-223KL	22	1.50	1.65	10	4.5	6.0	6.8	20	30
SER2918H-333KL	33	2.60	2.86	10	7.0	8.7	9.6	20	28
SER2915H-333KL	33	1.86	2.05	8	4.0	5.1	5.9	20	30
SER2915L-333KL	33	1.50	1.65	7	2.0	2.6	3.3	20	30

1. When ordering, specify **termination** code:

SER2915-333KL  
↓

**Termination:** L = RoHS compliant tin-silver over copper.

**Special order:**

T = RoHS tin-silver-copper (95.5/4/0.5) or  
S = non-RoHS tin-lead (63/37).

2. Inductance measured at 500 kHz, 0.1 Vrms, 0 Adc on an Agilent/HP 4284A LCR meter or equivalent.
3. DCR measured on a Keithley 580 micro-ohmmeter or equivalent.
4. SRF measured using an Agilent/HP 4395A network analyzer and an Agilent/HP 16092A test fixture.
5. DC current at 25°C that causes the specified inductance drop from its value without current. [Click for temperature derating information.](#) When Isat rating is less than Irms, Isat is the more critical specification.
6. Current that causes the specified temperature rise from 25°C ambient. This information is for reference only and does not represent absolute maximum ratings. [Click for temperature derating information.](#) When Irms is greater than Isat, Isat is the more critical specification, and Irms is shown in gray type. See Temperature Rise vs Current curve on next page.
7. Electrical specifications at 25°C. Refer to Doc 362 "Soldering Surface Mount Components" before soldering.



[www.coilcraft.com](http://www.coilcraft.com)

**US** +1-847-639-6400 [sales@coilcraft.com](mailto:sales@coilcraft.com)  
**UK** +44-1236-730595 [sales@coilcraft-europe.com](mailto:sales@coilcraft-europe.com)  
**Taiwan** +886-2-2264 3646 [sales@coilcraft.com.tw](mailto:sales@coilcraft.com.tw)  
**China** +86-21-6218 8074 [sales@coilcraft.com.cn](mailto:sales@coilcraft.com.cn)  
**Singapore** +65-6484 8412 [sales@coilcraft.com.sg](mailto:sales@coilcraft.com.sg)

Document 644-1 Revised 09/10/15

© Coilcraft Inc. 2015

This product may not be used in medical or high risk applications without prior Coilcraft approval. Specification subject to change without notice. Please check web site for latest information.



# Shielded Power Inductors - SER2900 Series

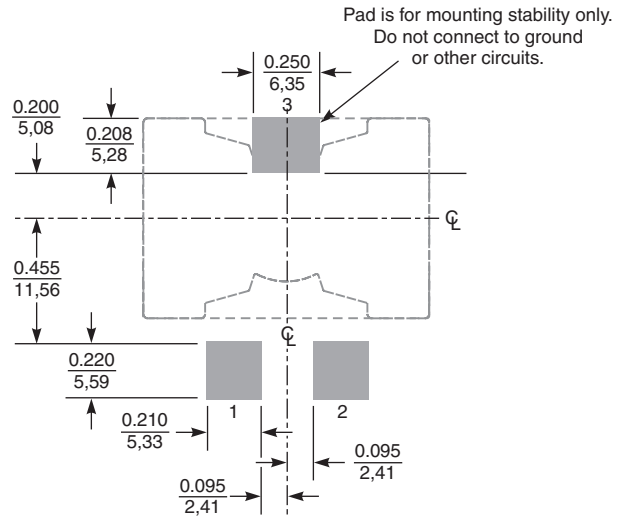
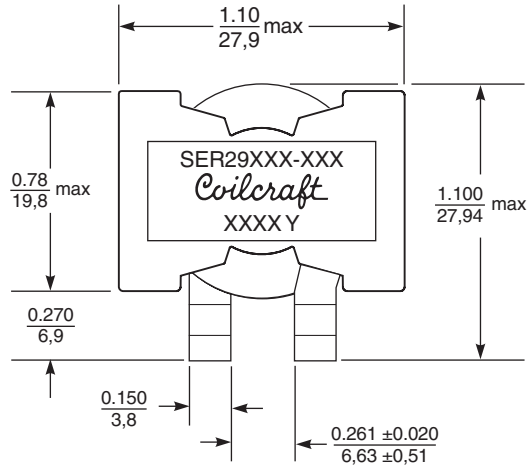

### Recommended Land Pattern

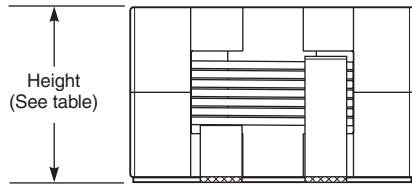
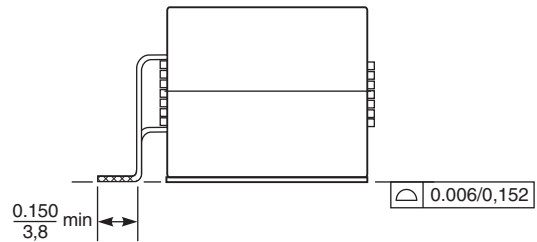

#### Maximum height

SER2915L	0.605 / 15,36
SER2915H	0.605 / 15,36
SER2918H	0.700 / 17,78

Dimensions are in inches  
mm

## Temperature Rise vs Current

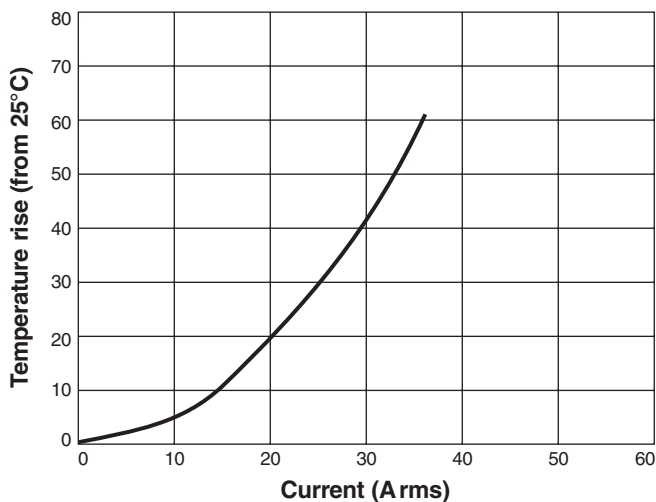

**US** +1-847-639-6400 sales@coilcraft.com  
**UK** +44-1236-730595 sales@coilcraft-europe.com  
**Taiwan** +886-2-2264 3646 sales@coilcraft.com.tw  
**China** +86-21-6218 8074 sales@coilcraft.com.cn  
**Singapore** + 65-6484 8412 sales@coilcraft.com.sg

Document 644-2 Revised 09/10/15

© Coilcraft Inc. 2015

This product may not be used in medical or high risk applications without prior Coilcraft approval. Specification subject to change without notice. Please check web site for latest information.



# Shielded Power Inductors - SER2900 Series

## L vs Current

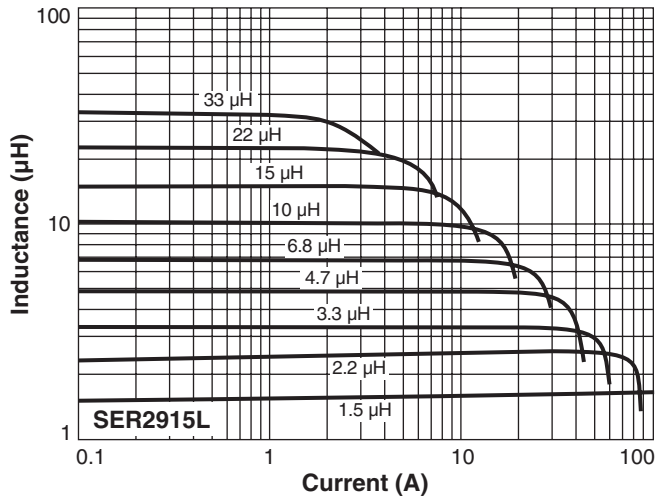

## L vs Frequency

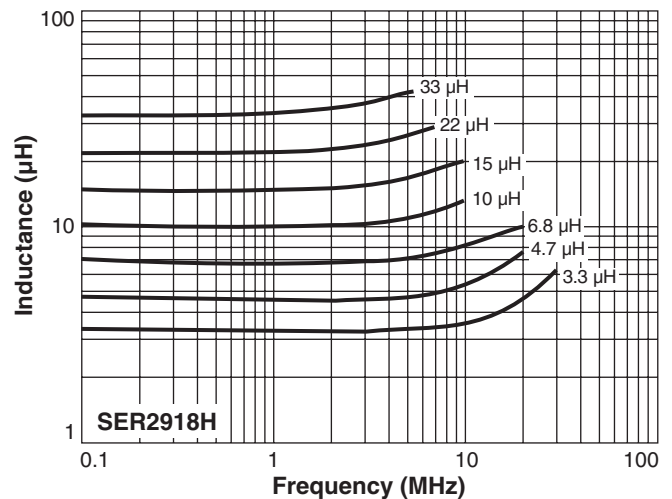
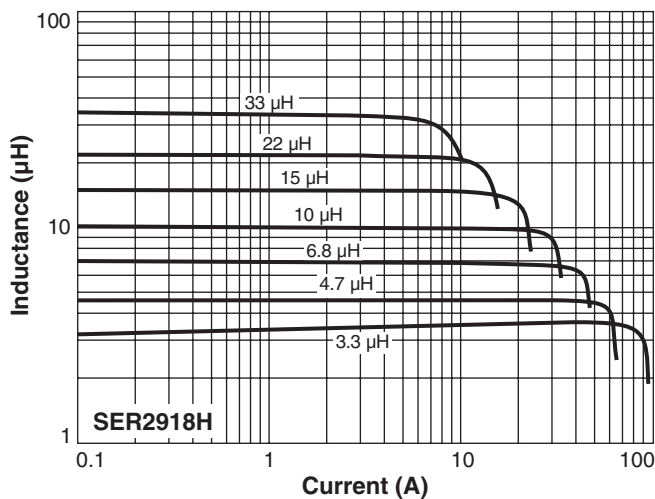
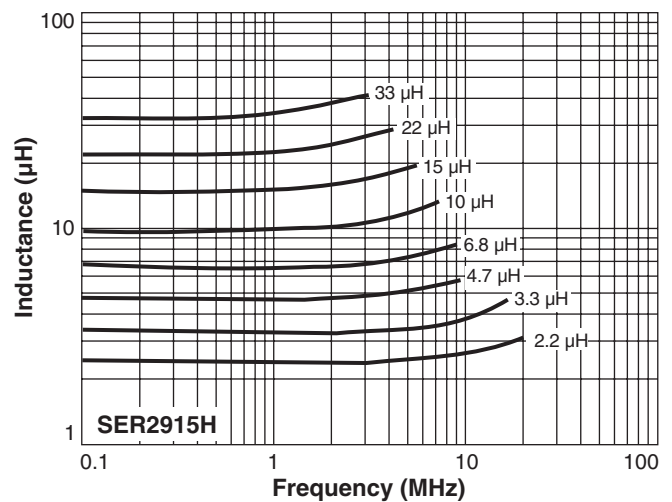
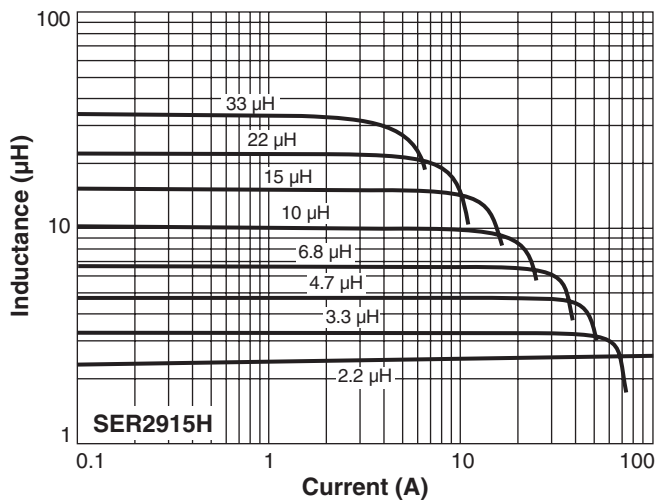
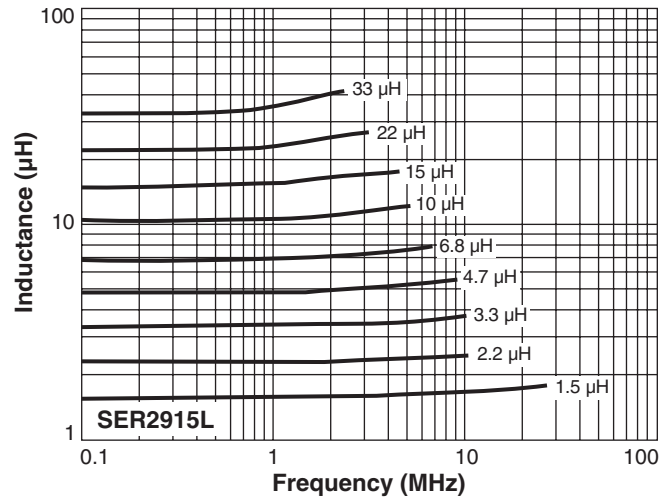

www.coilcraft.com

**US** +1-847-639-6400 sales@coilcraft.com  
**UK** +44-1236-730595 sales@coilcraft-europe.com  
**Taiwan** +886-2-2264 3646 sales@coilcraft.com.tw  
**China** +86-21-6218 8074 sales@coilcraft.com.cn  
**Singapore** + 65-6484 8412 sales@coilcraft.com.sg

Document 644-3 Revised 09/10/15

© Coilcraft Inc. 2015

This product may not be used in medical or high risk applications without prior Coilcraft approval. Specification subject to change without notice. Please check web site for latest information.



# Shielded Power Inductors - SER2900 Series

## ESR vs Frequency

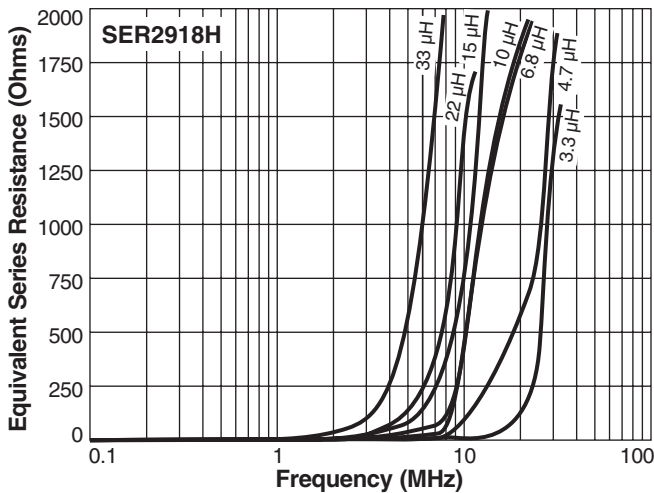
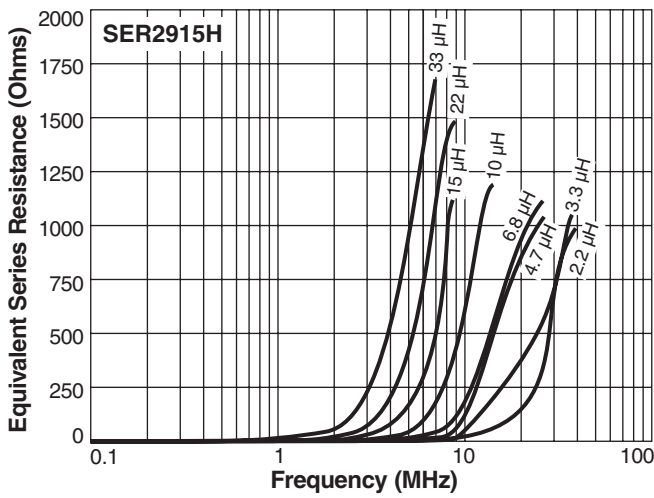
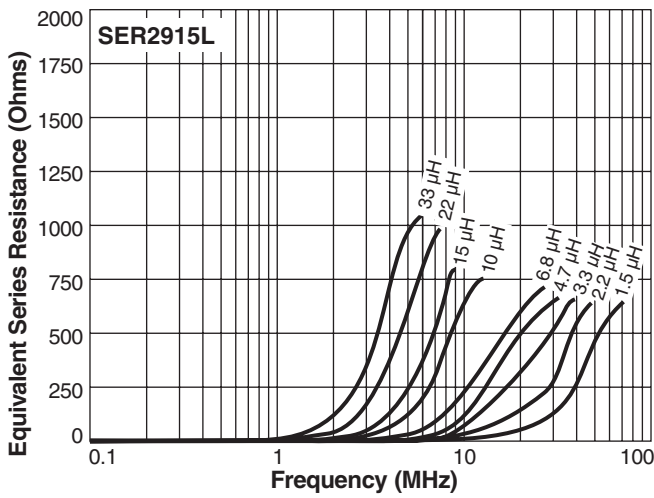

www.coilcraft.com

**US** +1-847-639-6400 sales@coilcraft.com  
**UK** +44-1236-730595 sales@coilcraft-europe.com  
**Taiwan** +886-2-2264 3646 sales@coilcraft.com.tw  
**China** +86-21-6218 8074 sales@coilcraft.com.cn  
**Singapore** + 65-6484 8412 sales@coilcraft.com.sg

Document 644-4 Revised 09/10/15

© Coilcraft Inc. 2015

This product may not be used in medical or high risk applications without prior Coilcraft approval. Specification subject to change without notice. Please check web site for latest information.