

Change hole size to 1.8mm 2024.8.19

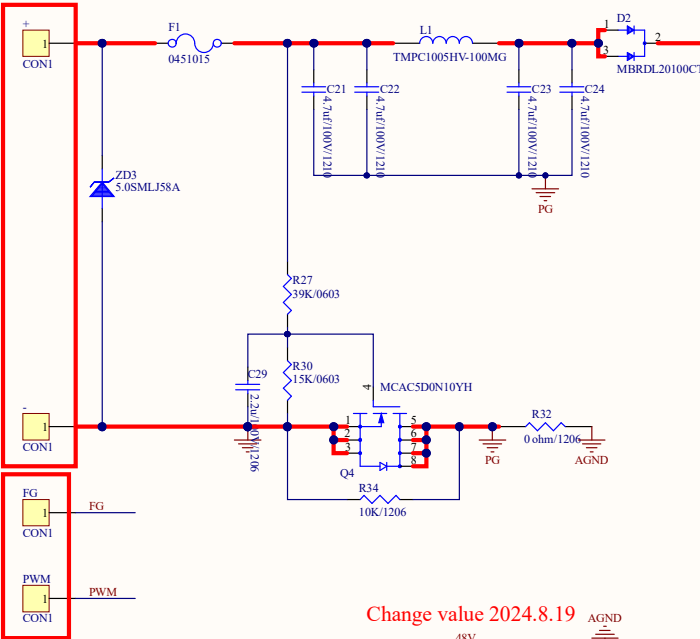

8A Change size 2024.8.19

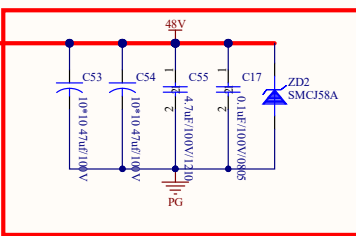

Change value 2024.8.19

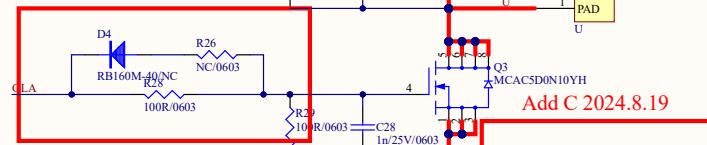
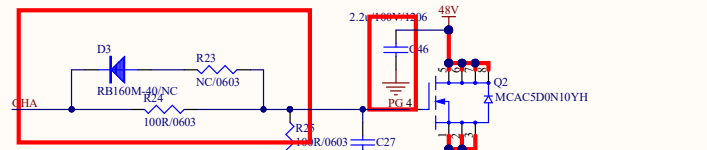

Change value 2024.8.19

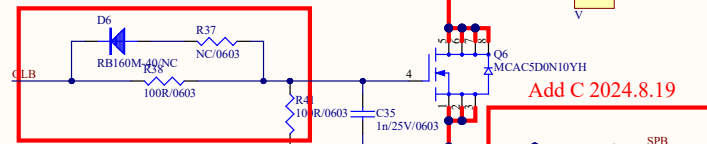
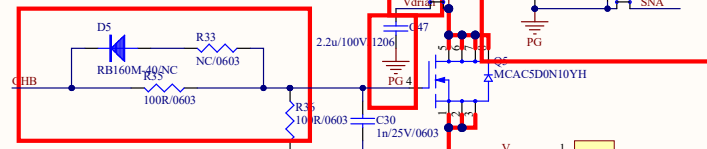

Change value 2024.8.19

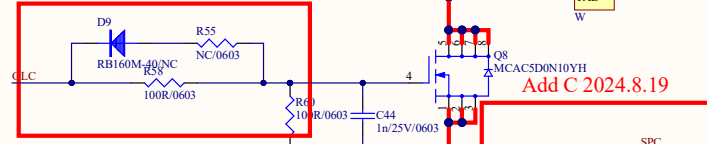
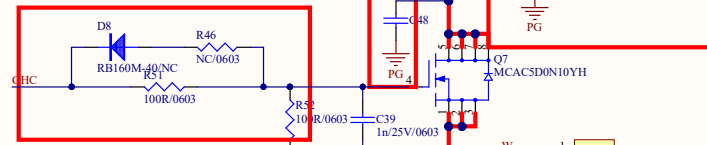

Change hole size to 1.2mm 2024.8.19

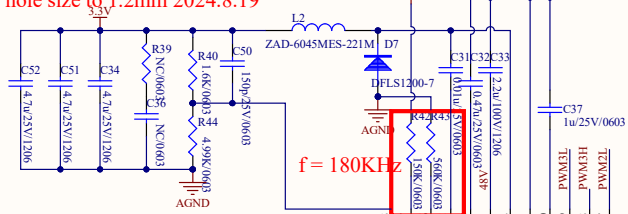

Change value 2024.8.19

f = 180KHz

Change value 2024.8.19

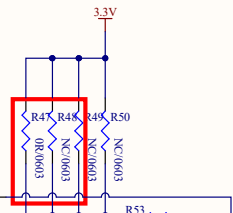

Gain = 40V/V
OC = 30A
150/300mA

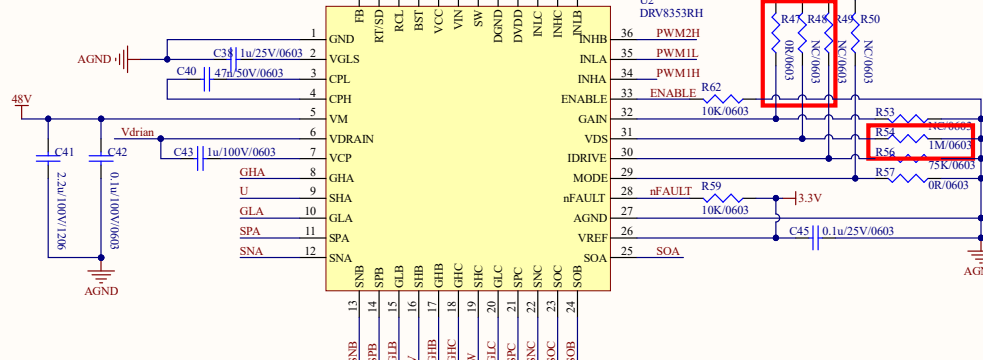

Add C 2024.8.19

Add C 2024.8.19

Add C 2024.8.19

Add C 2024.8.19