

1. Circuit and Artwork

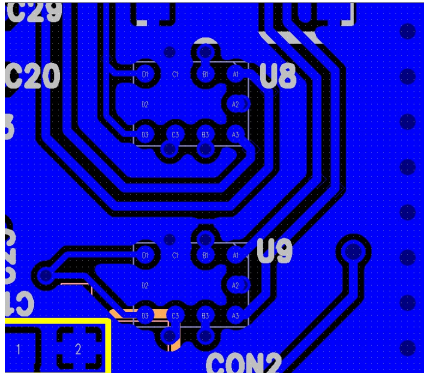

1st Layer

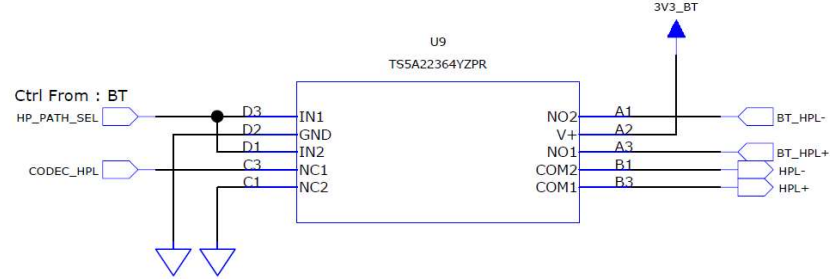
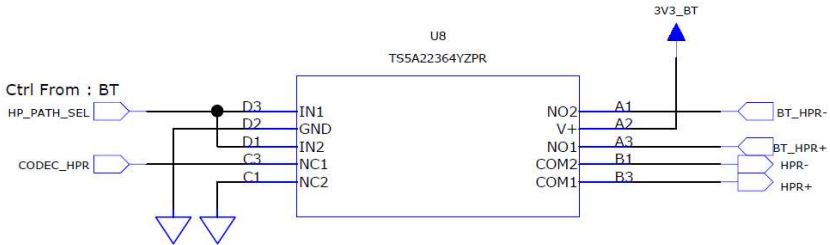
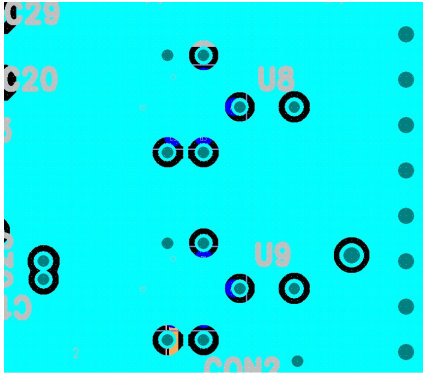

2nd Layer

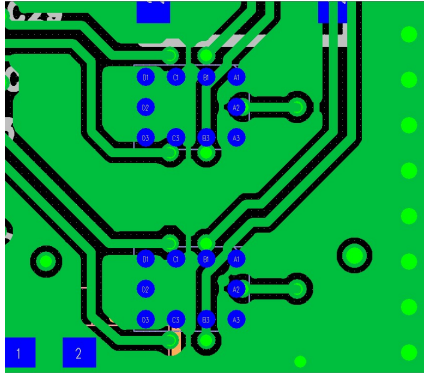

3rd Layer

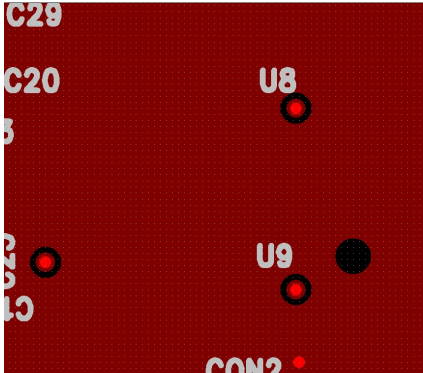

4th Layer

2. THD+N test (Input)

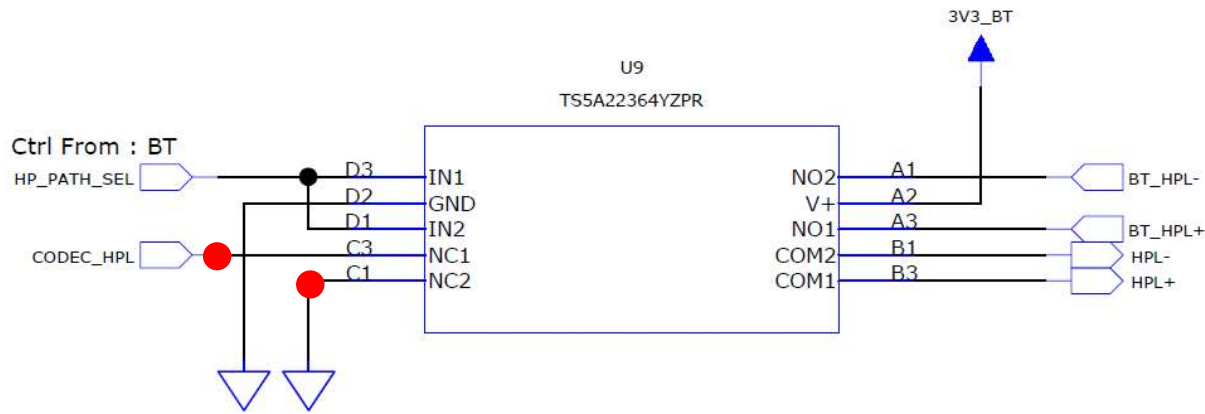

Test Equipment : APx525B
Load : 16 Ohm

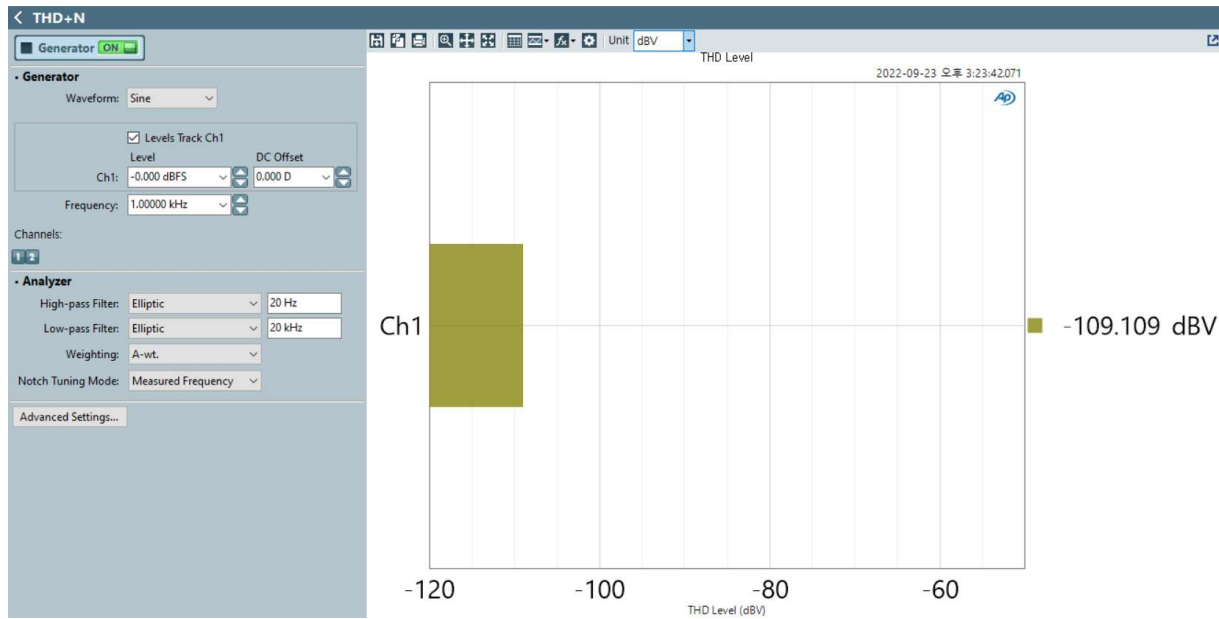

THD+N test environment and Result

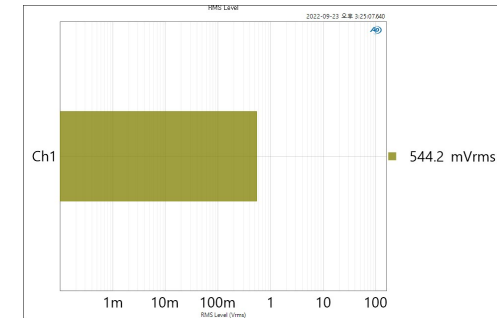

Vrms

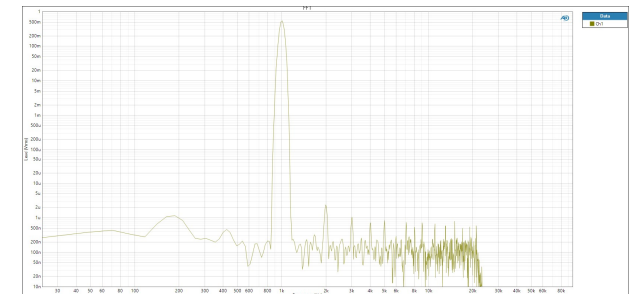

FFT

3. THD+N test (Output)

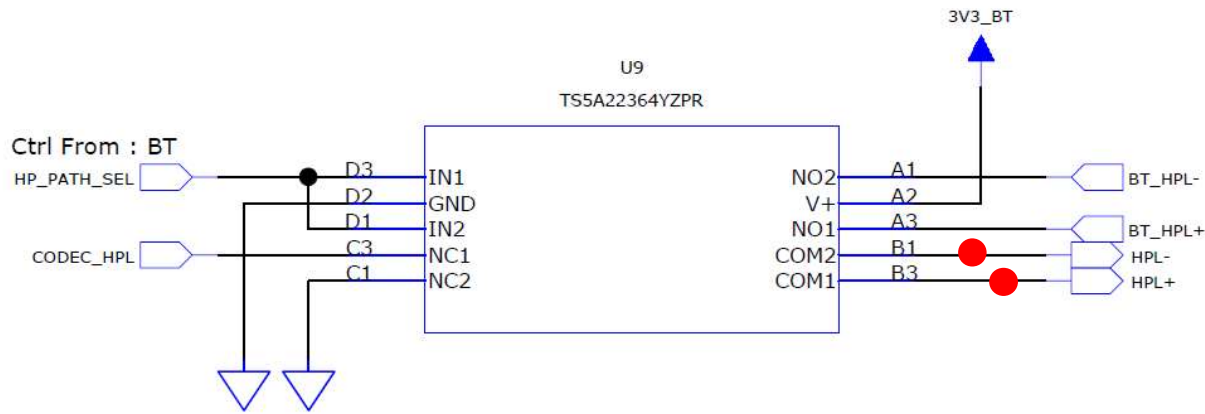

Test Equipment : APx525B
Load : 16 Ohm

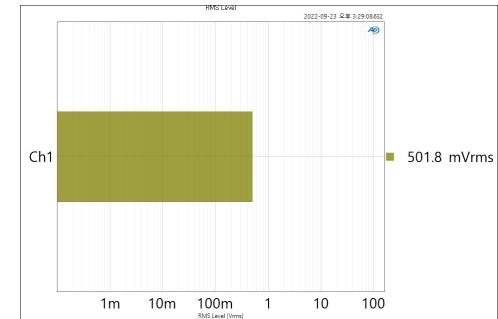
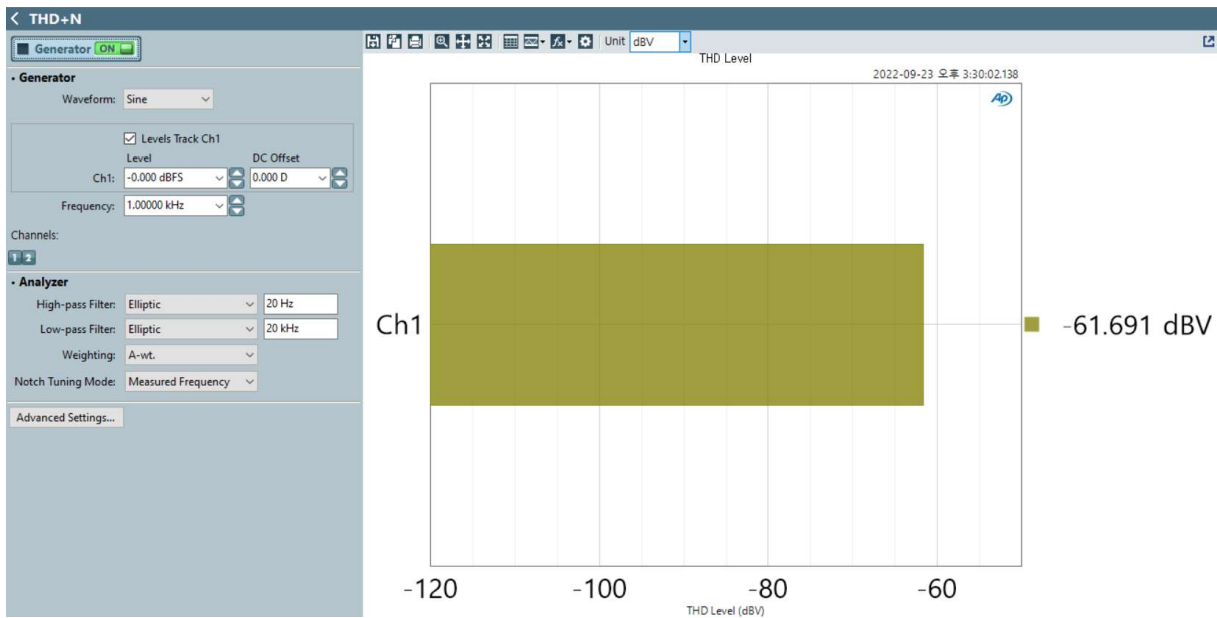

Vrms

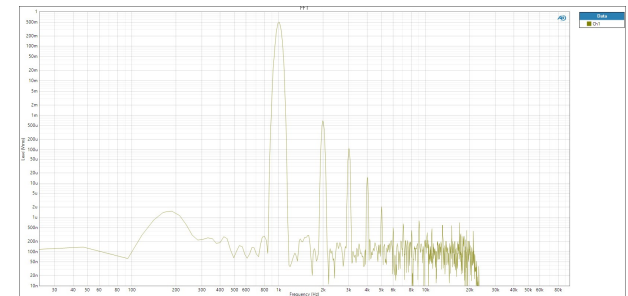

FFT