

To FRONT PCB

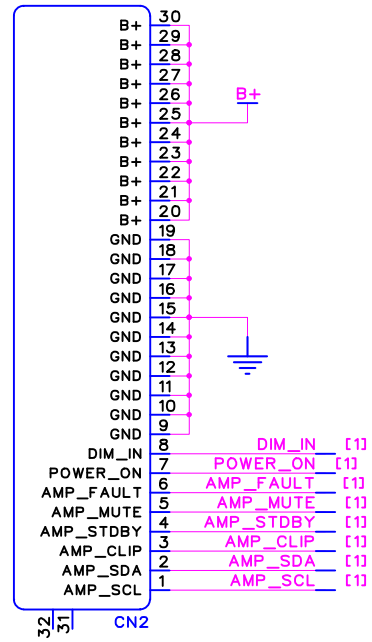

12K -->2.2K -2021-1020

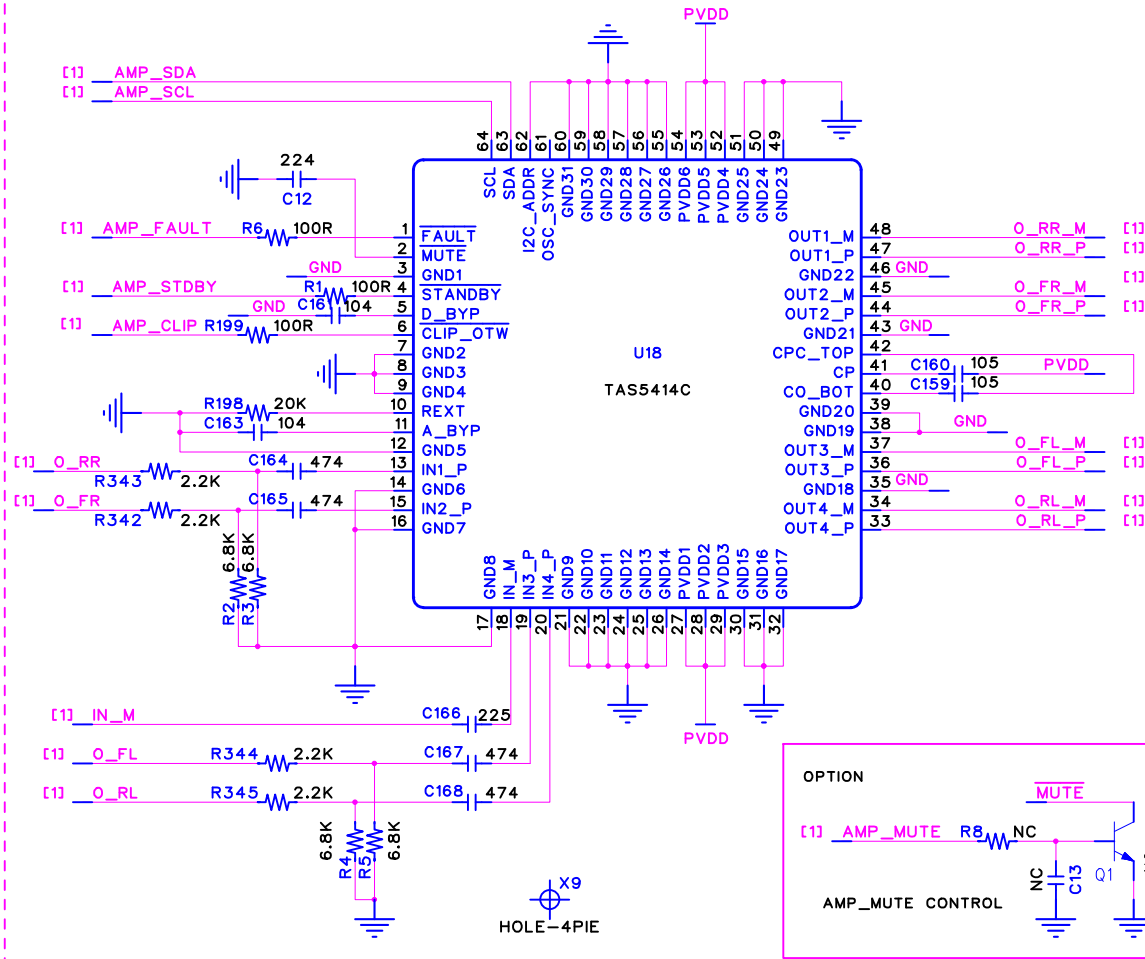

TEST POINTS

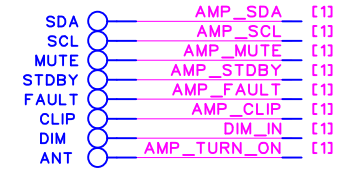

SPEAKER FILTERS

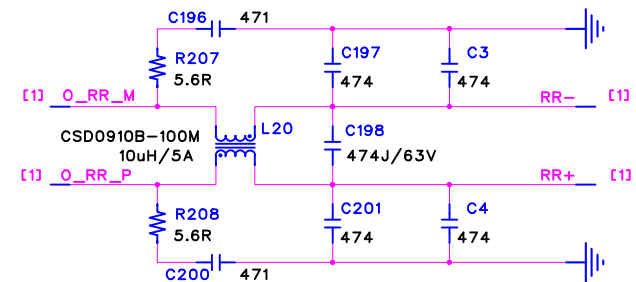
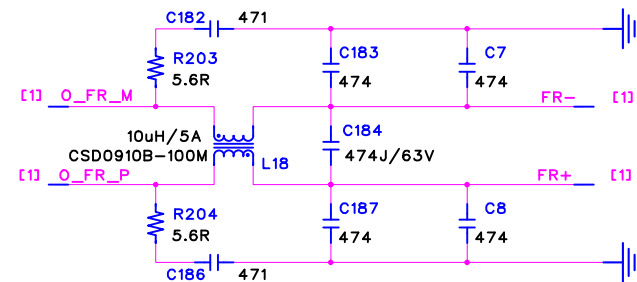
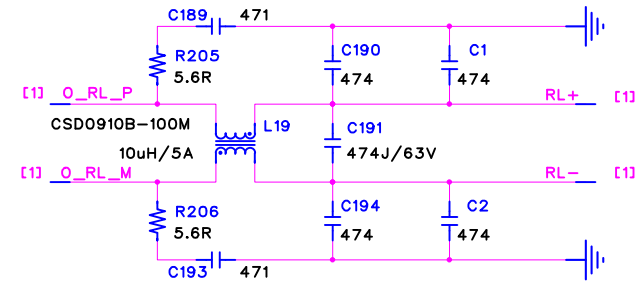
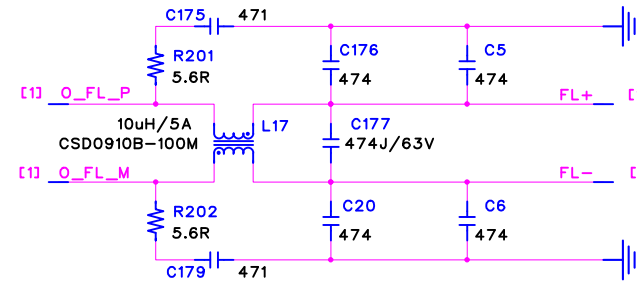

To Mid PCB

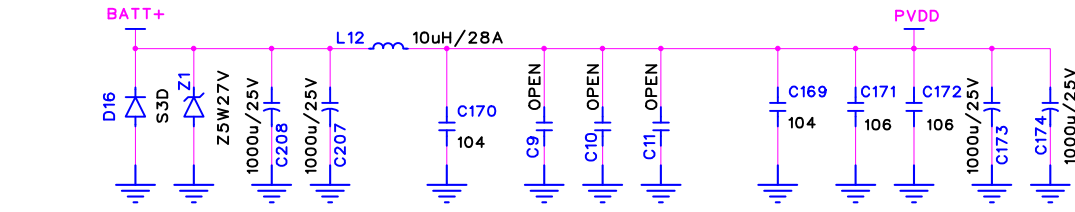
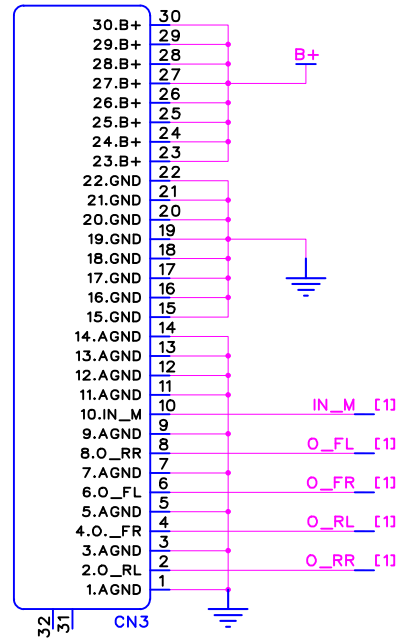

EXTERNAL AMP-REMOTE CONTROL

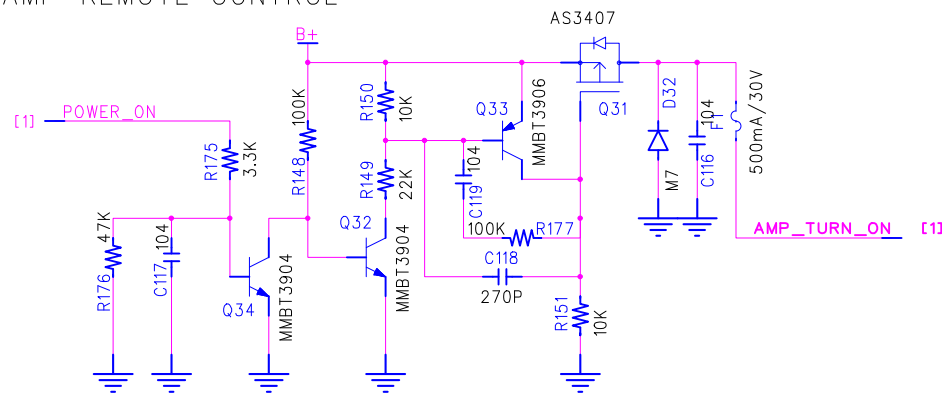

SPEAKER CONNECTOR

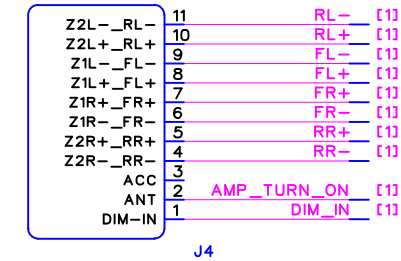
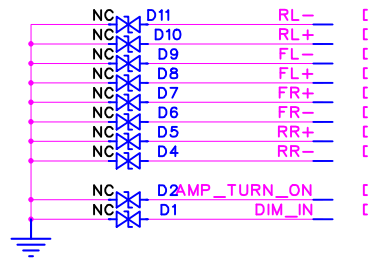

B+ CONNECTOR

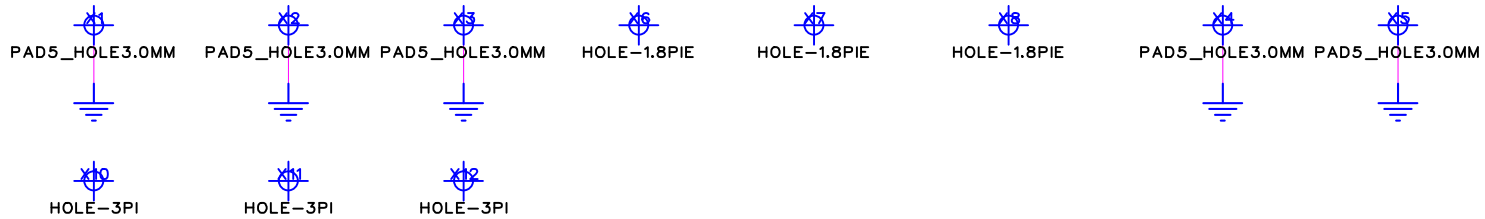
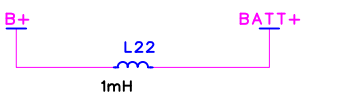
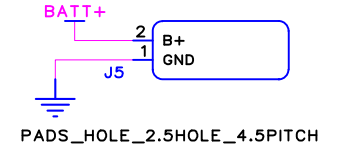

TITLE	CMM30-AMP-PCB SCHEMATIC DIAGRAM					A3
SHEET	1.DIGITAL_AMP					
DATE:	NUMBER	DRAWN	APPROVED	PAGE	REV	
2022-01-23	SCH-CMM30-1	BC.BEAK		1 / 1	V06	

ADO Electronics Co.,Ltd.