

Title		
AMPLIFIER		
Size	Document Number	Rev
A	<Doc>	<RevCode>
Date:	Friday, March 30, 2018	Sheet 1 of 1

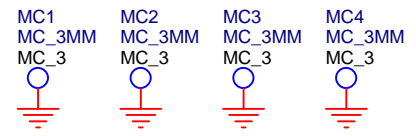
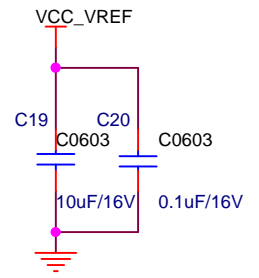
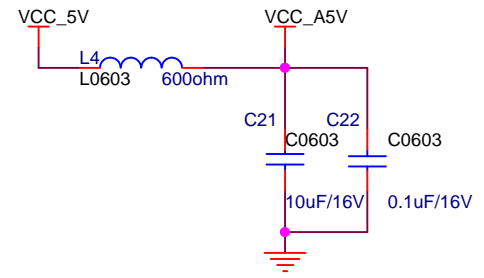
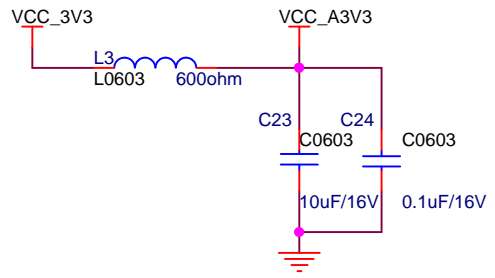
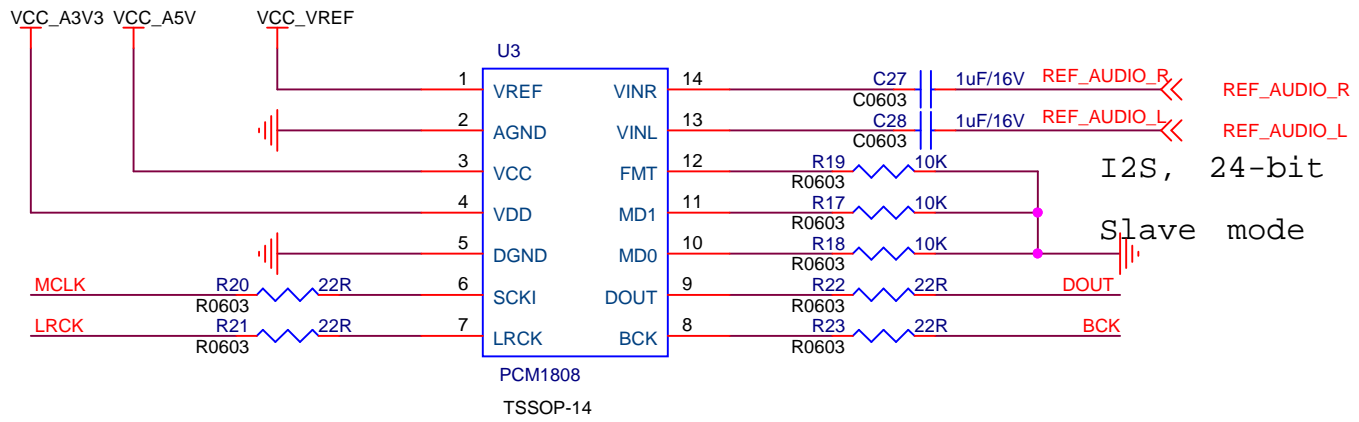
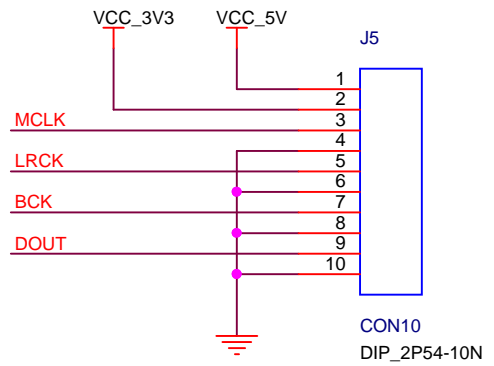
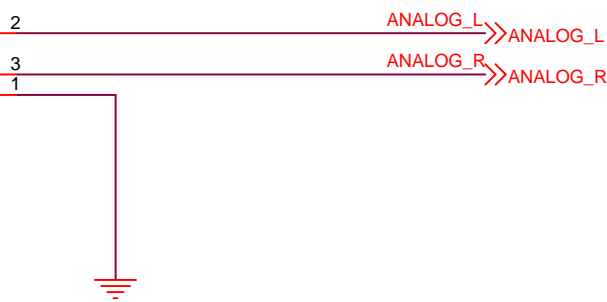
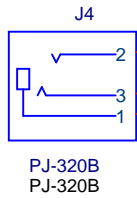

Title		
DAC & CONNECTOR		
Size	Document Number	Rev
A	<Doc>	<RevCode>
Date: Friday, March 30, 2018		Sheet 1 of 1