

TSW14J10 FMC-USB Interposer Card

This user's guide describes the functionality, hardware, operation, and software instructions for the TSW14J10 FMC-USB interposer card. Throughout this document, the abbreviations TSW14J10EVM, EVM, and the term *evaluation module* are synonymous with the TSW14J10 Evaluation Module, unless otherwise noted.

Contents

1	Introduction	2
2	Functionality	2
3	Hardware Configuration	4
	3.1 Power Connections	4
	3.2 Jumpers	4
	3.3 Connectors	5
4	Software Start Up	9
	4.1 Installation Instructions	9
	4.2 USB Interface and Drivers	11
5	Downloading Firmware Example	13
6	DAC and ADC GUI Configuration File Changes When Using a Xilinx Development Platform	15
	6.1 DAC38J84EVM with Xilinx VC707 Development Board Setup Example	16
	6.2 ADC32RF45EVM With Xilinx VC707 Development Board Setup Example	21
	6.3 ADC12J4000EVM With Xilinx VC707 Development Board Setup Example	25
	6.4 ADC12J4000EVM With a Xilinx Zynq ZC706 Development Board Setup Example.....	30
	6.5 DAC38J84EVM With a Xilinx Zynq ZC706 Development Board Setup Example.....	32

List of Figures

1	TSW14J10EVM, ADS42JB69EVM, and Kintex KC705 Development Card	3
2	TSW14J10 EVM Block Diagram	4
3	GUI Installation.....	9
4	TSW14J10EVM Serial Number	11
5	High Speed Data Converter Pro GUI Top Level	11
6	Hardware Device Manager	12
7	DAC38J84EVM GUI Setup Example	16
8	Quick Start Menu	17
9	LMK04828 Clock Outputs Menu	18
10	LMK04828 Clock Outputs Menu	19
11	HSDC Pro GUI	20
12	HSDC Pro GUI: Lane Rate and REFCLK Settings	20
13	ADC32RF45EVM, TSW14J10EVM and VC707 Board	21
14	ADC32RFxx GUI LMK0828 Clock Outputs Tab	22
15	Updated LMK0828 Clock Outputs Tab	23
16	HSDC Pro GUI	23
17	Captured Results for Channel A	24
18	ADC12J4000EVM, TSW14J10EVM and VC707 Board.....	25

Altera is a registered trademark of Altera Corporation.
Xilinx, Kintex are registered trademarks of Xilinx Corporation.

19	ADC12J4000EVM GUI	26
20	LMK04828 Address 0x100.....	27
21	LMK04828 Address 0x110.....	28
22	HSDC Pro GUI	28
23	Captured Results for the ADC12J4000 in Bypass Mode	29
24	ADC12J4000EVM, TSW14J10EVM and ZC706 board	30
25	Captured Results for the ADC12J4000 in Bypass Mode	31
26	DAC38J84EVM, TSW14J10EVM and ZC706 Board.....	32
27	Serial Number Selection Window	33
28	HSDC Pro GUI	34
29	HSDC Pro GUI	34

List of Tables

1	TSW14J10 Jumper Descriptions	5
2	FPGA FMC Connector (J5) Description of the TSW14J10	5
3	ADC/DAC EVM FMC Connector (J4) Description of the TSW14J10	7

1 Introduction

The Texas Instruments TSW14J10 Evaluation Module (EVM) allows users to operate the High Speed Data Converter Pro Graphic User Interface (HSDC Pro GUI) Software on certain Xilinx® and Altera® development kits that incorporate the FMC connector. This FMC-FMC adapter has a four bus FTDI USB-to-GPIO device, that when connected to a PC, provides an interface to the FPGA on the development platform allowing the HSDC Pro GUI to operate as if it were connected to a TI development board. The TSW14J10 is compatible with all TI ADC and DAC JESD204B-based EVMs. Contact FPGA vendors for other available firmware not provided by HSDC Pro Software to test ADC and DAC EVMs with their development platform.

2 Functionality

The TSW14J10 uses two industry standard FMC connectors that provide an interface between an FMC-based development board and all TI JESD204B ADC and DAC EVMs. To acquire data, receive data, and do register read and writes using a host PC, the FPGA transmits and receives data across three Serial Peripheral Interface (SPI) busses using dedicated pins on the FMC that connect to the FTDI on the TSW14J10. The fourth bus connects to a JTAG connector. When connecting the provided cable between this connector and a JTAG connector on a FPGA development platform, the HSDC Pro GUI can be used to configure the FPGA. This interface is also routed to the FMC connector when setting jumpers to the appropriate configuration (see [Table 1](#)).

The TSW14J10 routes the SPI busses through level translators that allow the signals going to the FPGA development board and the ADC/DAC EVM to be either 3.3-V or 1.8-V levels. All devices on the TSW14J10 are powered from the USB connection.

[Figure 1](#) shows an ADS42JB69EVM connected to a Xilinx Kintex® KC705 development board using a TSW14J10EVM.

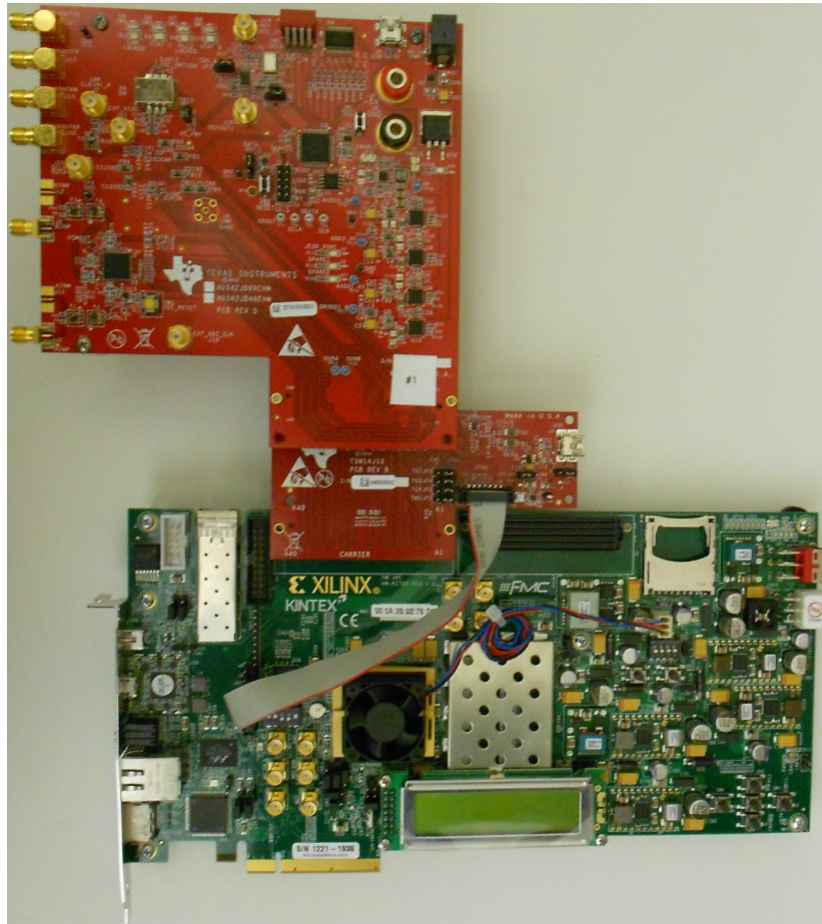

Figure 1. TSW14J10EVM, ADS42JB69EVM, and Kintex KC705 Development Card

The major features of the TSW14J10 are:

- 10 transceiver lanes with speeds up to 12.5 Gbps
- Industry-standard JTAG connector
- Supports 1.8-V, 3.3-V CMOS IO interface
- Onboard FT4232HL USB device for JTAG, SPI interface
- Supported by TI HSDC PRO software
- 2 Samtec high-speed, high-density FMC connectors

Figure 2 shows a block diagram of the TSW14J10 EVM.

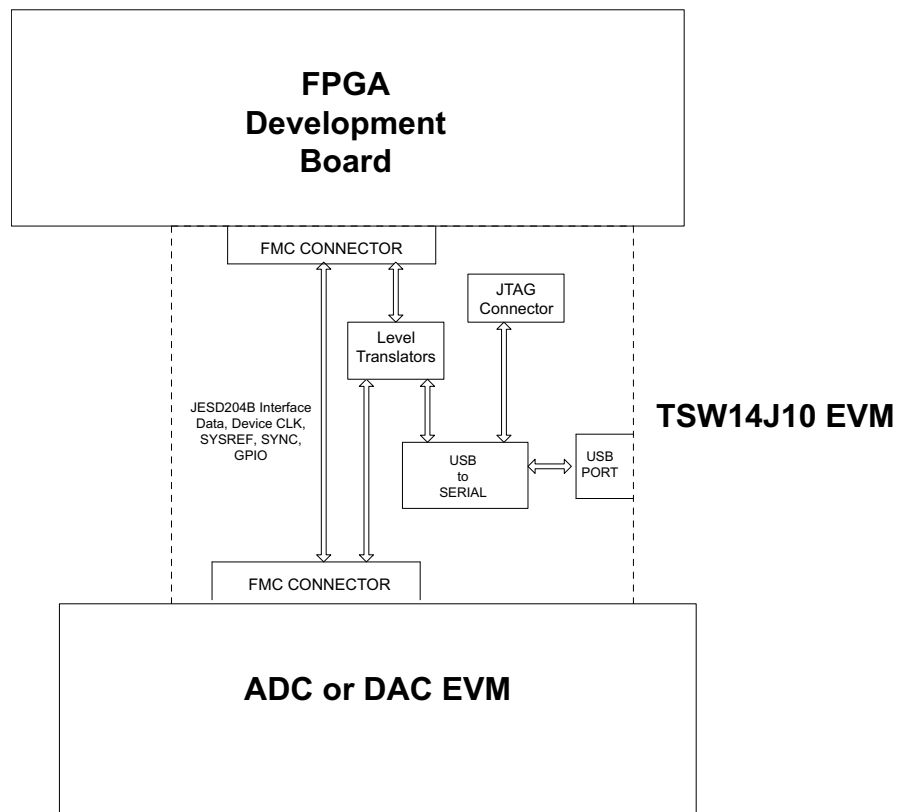

Figure 2. TSW14J10 EVM Block Diagram

3 Hardware Configuration

In this section, the various portions of the TSW14J10EVM hardware are described. The TSW14J10EVM comes with a 10 pin ribbon cable that is used as a programming option for the FPGA on the FPGA Development Board, plastic screws and nuts to secure the three boards together, and stand-off extenders to be used on the ADC/DAC EVM due to the new height of the interface FMC connector.

3.1 Power Connections

The TSW14J10EVM hardware is designed to operate from a single-supply voltage of +5 VDC. By default, this power input is provided by the USB connection. A second option is to provide external +5 V to test point TP12 and shunt pins 1-2 on JP1. This will remove the USB power from the +5-V power traces and connect it to TP12. The external source should be able to provided 0.5 A.

3.2 Jumpers

The TSW14J10 contains several jumpers (JP) and solder jumpers (SJP) that enable certain functions on the board. The description of the jumpers are found in [Table 1](#). In addition to the jumpers, there are several 0 Ohm resistors that are used as jumpers. If using the TSW14J10EVM with the Xilinx ZC706 and a TI DAC EVM, the following resistors need to be removed or installed to route the SYNC signals from the DAC EVM to the correct pins on the ZC706 board:

Install R142, R144, R146 and R148

Remove R143 and R145

Table 1. TSW14J10 Jumper Descriptions

Component	Description	Default
JP1	USB power select. Default is power from the USB interface.	2-3
JP2–JP5	FTDI connected to JTAG connector or FMC. Default is JTAG connector.	1-2
JP6	Translator voltage level select (1.8 V or 3.3 V). Default is 3.3 V.	2-3
SJP1	Direction control for buffer U9. Default is A to B.	1-2
SJP2	Direction control for buffer U10. Default is B to A.	2-3
SJP3	Direction control for buffer U11. Default is B to A.	2-3

3.3 Connectors

3.3.1 FPGA Development Platform FMC Connector

The TSW14J10 EVM has one FPGA Mezzanine Card Connector (FMC) to allow for direct plug in of a TI JESD204B serial interface ADC or DAC EVM and another to plug into an FPGA development board. The specifications for this connector were mostly derived from the ANSI/VITA 57.1 FPGA Mezzanine Card Standard. This standard describes the compliance requirements for a low overhead protocol bridge between a carrier card's IO and an FPGA processing device on a carrier card. This specification is being used by FPGA vendors on their development platforms.

FMC connector J5 provides the interface between the TSW14J10EVM and a FPGA development platform. This 400-pin Samtec high-speed, high-density connector, part number SEAF-40-05.0-S-10-2-A-K, is suitable for high-speed differential pairs up to 21 Gbps. In addition to the JESD204B standard signals, 13 CMOS single-ended signals are sourced from the USB interface to the FMC connector. These signals are used by the HSDC Pro GUI to program internal registers and read and write data to the FPGA. The connector pinout description is shown in [Table 2](#).

Table 2. FPGA FMC Connector (J5) Description of the TSW14J10

FMC Signal Name	FMC Pin	Standard JESD204 Application Mapping	Description
DP0_M2C_P/N	C6/C7	Lane 0+/- (M->C)	JESD Serial data transmitted from Mezzanine and received by Carrier
DP1_M2C_P/N	A2/A3	Lane 1+/- (M->C)	JESD Serial data transmitted from Mezzanine and received by Carrier
DP2_M2C_P/N	A6/A7	Lane 2+/- (M->C)	JESD Serial data transmitted from Mezzanine and received by Carrier
DP3_M2C_P/N	A10/A11	Lane 3+/- (M->C)	JESD Serial data transmitted from Mezzanine and received by Carrier
DP4_M2C_P/N	A14/A15	Lane 4+/- (M->C)	JESD Serial data transmitted from Mezzanine and received by Carrier
DP5_M2C_P/N	A18/A19	Lane 5+/- (M->C)	JESD Serial data transmitted from Mezzanine and received by Carrier
DP6_M2C_P/N	B16/B17	Lane 6+/- (M->C)	JESD Serial data transmitted from Mezzanine and received by Carrier
DP7_M2C_P/N	B12/B13	Lane 7+/- (M->C)	JESD Serial data transmitted from Mezzanine and received by Carrier
DP8_M2C_P/N	B8/B9	Lane 8+/- (M->C)	JESD Serial data transmitted from Mezzanine and received by Carrier
DP9_M2C_P/N	B4/B5	Lane 9+/- (M->C)	JESD Serial data transmitted from Mezzanine and received by Carrier
DP0_C2M_P/N	C2/C3	Lane 0+/- (C->M)	JESD Serial data transmitted from Carrier and received by Mezzanine
DP1_C2M_P/N	A22/A23	Lane 1+/- (C->M)	JESD Serial data transmitted from Carrier and received by Mezzanine
DP2_C2M_P/N	A26/A27	Lane 2+/- (C->M)	JESD Serial data transmitted from Carrier and received by Mezzanine
DP3_C2M_P/N	A30/A31	Lane 3+/- (C->M)	JESD Serial data transmitted from Carrier and received by Mezzanine
DP4_C2M_P/N	A34/A35	Lane 4+/- (C->M)	JESD Serial data transmitted from Carrier and received by Mezzanine
DP5_C2M_P/N	A38/A39	Lane 5+/- (C->M)	JESD Serial data transmitted from Carrier and received by Mezzanine
DP6_C2M_P/N	B36/B37	Lane 6+/- (C->M)	JESD Serial data transmitted from Carrier and received by Mezzanine
DP7_C2M_P/N	B32/B33	Lane 7+/- (C->M)	JESD Serial data transmitted from Carrier and received by Mezzanine
DP8_C2M_P/N	B28/B29	Lane 8+/- (C->M)	JESD Serial data transmitted from Carrier and received by Mezzanine
DP9_C2M_P/N	B24/B25	Lane 9+/- (C->M)	JESD Serial data transmitted from Carrier and received by Mezzanine
GTX_CLKP/M	D4/D5	DEVCLKA+/- (M->C)	Primary carrier-bound reference clock required for FPGA gigabit transceivers. Equivalent to device clock.
Device Clock, SYSREF, and SYNC			
FMC Signal Name	FMC Pin	Standard JESD204 Application Mapping	Description

Table 2. FPGA FMC Connector (J5) Description of the TSW14J10 (continued)

CLK_LA0_P/N	G6/G7	DEVCLKB+/- (M->C)	Secondary carrier-bound device clock. Used for special FPGA functions such as sampling SYSREF.
D8/D9	D8/D9	DEVCLK+/- (C->M)	Mezzanine-bound device Clock. Used for low noise conversion clock.
CAR_SYSREFP/M	G9/G10	SYSREF+/- (M->C)	Carrier-bound SYSREF signal
D11/D12	D11/D12	SYSREF+/- (C->M)	Mezzanine-bound SYSREF signal
SYNCP/M	G12/G13	SYNC+/- (C->M)	ADC Mezzanine-bound SYNC signal for use in class 0/1/2 JESD204 systems
DAC_SYNC_P/M	F10/F11	DAC SYNC+/- (M->C)	Carrier-bound SYNC signal for use in class 0/1/2 JESD204 systems.
ALT_DAC_SYNC_PM	F19/F20	Alt. DAC SYNC+/- (M->C)	Alternate Carrier-bound SYNC signal for use in class 0/1/2 JESD204B systems.
ALT_SYNCP/M	H31/H32	Alt. SYNC+/- (C->M)	Alternate ADC Mezzanine-bound SYNC signal. For use when SYNC (C->M) is not available.
SYNC	K22	DAC SYNC (M->C)	Alternate Carrier-bound CMOS level SYNC signal for use in class 0/1/2 JESD204 systems.
Special Purpose I/O			
FMC Signal Name	FMC Pin	Direction	Description
F1	F1		Power good from mezzanine to carrier
D1	D1		Power good from carrier to mezzanine
PRESENT	H2	ADC/DAC-to-FPGA	EVM Present indicator
ADBUS0_T	C14	USB-to-FPGA	USB SPI Interface signal
ADBUS1_T	C15	USB-to-FPGA	USB SPI Interface signal
ADBUS2_T	H8	FPGA-to-USB	USB SPI Interface signal
ADBUS3_T	D14	USB-to-FPGA	USB SPI Interface signal
ADBUS4_T	C10	USB-to-FPGA	USB SPI Interface signal
BDBUS0_T	D15	USB-to-FPGA	USB SPI Interface signal
BDBUS1_T	G15	USB-to-FPGA	USB SPI Interface signal
BDBUS2_T	H10	FPGA-to-USB	USB SPI Interface signal
BDBUS3_T	G16	USB-to-FPGA	USB SPI Interface signal
CDBUS0_T	H16	USB-to-FPGA	USB SPI Interface signal
CDBUS1_T	H17	USB-to-FPGA	USB SPI Interface signal
CDBUS2_T	H11	FPGA-to-USB	USB SPI Interface signal
CDBUS3_T	H7	USB-to-FPGA	USB SPI Interface signal
TCK	D29	USB-to-JTAG	JTAG connector clock
TDI	D30	USB-to-JTAG	JTAG connector TDI
TDO	D31	JTAG-to-USB	JTAG connector TDO
TMS	D33	USB-to-JTAG	JTAG connector TMS
OVRA	K19	ADC-to-FPGA	ADC over range indicator
OVRB	E18	ADC-to-FPGA	ADC over range indicator
OVRC	J22	ADC-to-FPGA	ADC over range indicator
OVRD	J21	ADC-to-FPGA	ADC over range indicator
DAC-SYNC+/-	E2/E3	DAC-to-FPGA	Spare sync
FPGA_CLK2P/N	J2/J3	FPGA-to-DAC	Spare clock
FPGA_CLK1P/N	K4/K5	FPGA-to-DAC	Spare clock
LED_SYNC1	C18	FPGA-to-ADC	SYNC LED indicator
SPLED0	D17	FPGA-to-ADC	Spare LED
SPLED1	D18	FPGA-to-ADC	Spare LED
C19	C19		Spare connection
C26	C26		Spare connection
C27	C27		Spare connection
D26	D26		Spare connection
E19	E19		Spare connection
G27	G27		Spare connection

Table 2. FPGA FMC Connector (J5) Description of the TSW14J10 (continued)

G36	G36		Spare connection
G37	G37		Spare connection
H37	H37		Spare connection
H38	H38		Spare connection

3.3.2 ADC/DAC FMC Connector

FMC connector J4 provides the interface between the TSW14J10EVM and an ADC or DAC EVM. In addition to the JESD204B standard signals, 8 CMOS single-ended signals are sourced from the USB interface to the FMC connector. These signals are used to allow the HSDC Pro GUI to control the SPI serial programming of an ADC or DAC EVM that supports this feature. Several other spare signals are available that connect between this connector and the FPGA FMC connector. The connector pinout description is shown in [Table 3](#).

Table 3. ADC/DAC EVM FMC Connector (J4) Description of the TSW14J10

FMC Signal Name	FMC Pin	Standard JESD204 Application Mapping	Description
DP0_M2C_P/N	C6/C7	Lane 0+/- (M->C)	JESD Serial data transmitted from Mezzanine and received by Carrier
DP1_M2C_P/N	A2/A3	Lane 1+/- (M->C)	JESD Serial data transmitted from Mezzanine and received by Carrier
DP2_M2C_P/N	A6/A7	Lane 2+/- (M->C)	JESD Serial data transmitted from Mezzanine and received by Carrier
DP3_M2C_P/N	A10/A11	Lane 3+/- (M->C)	JESD Serial data transmitted from Mezzanine and received by Carrier
DP4_M2C_P/N	A14/A15	Lane 4+/- (M->C)	JESD Serial data transmitted from Mezzanine and received by Carrier
DP5_M2C_P/N	A18/A19	Lane 5+/- (M->C)	JESD Serial data transmitted from Mezzanine and received by Carrier
DP6_M2C_P/N	B16/B17	Lane 6+/- (M->C)	JESD Serial data transmitted from Mezzanine and received by Carrier
DP7_M2C_P/N	B12/B13	Lane 7+/- (M->C)	JESD Serial data transmitted from Mezzanine and received by Carrier
DP8_M2C_P/N	B8/B9	Lane 8+/- (M->C)	JESD Serial data transmitted from Mezzanine and received by Carrier
DP9_M2C_P/N	B4/B5	Lane 9+/- (M->C)	JESD Serial data transmitted from Mezzanine and received by Carrier
DP0_C2M_P/N	C2/C3	Lane 0+/- (C->M)	JESD Serial data transmitted from Carrier and received by Mezzanine
DP1_C2M_P/N	A22/A23	Lane 1+/- (C->M)	JESD Serial data transmitted from Carrier and received by Mezzanine
DP2_C2M_P/N	A26/A27	Lane 2+/- (C->M)	JESD Serial data transmitted from Carrier and received by Mezzanine
DP3_C2M_P/N	A30/A31	Lane 3+/- (C->M)	JESD Serial data transmitted from Carrier and received by Mezzanine
DP4_C2M_P/N	A34/A35	Lane 4+/- (C->M)	JESD Serial data transmitted from Carrier and received by Mezzanine
DP5_C2M_P/N	A38/A39	Lane 5+/- (C->M)	JESD Serial data transmitted from Carrier and received by Mezzanine
DP6_C2M_P/N	B36/B37	Lane 6+/- (C->M)	JESD Serial data transmitted from Carrier and received by Mezzanine
DP7_C2M_P/N	B32/B33	Lane 7+/- (C->M)	JESD Serial data transmitted from Carrier and received by Mezzanine
DP8_C2M_P/N	B28/B29	Lane 8+/- (C->M)	JESD Serial data transmitted from Carrier and received by Mezzanine
DP9_C2M_P/N	B24/B25	Lane 9+/- (C->M)	JESD Serial data transmitted from Carrier and received by Mezzanine
GTX_CLKP/M	D4/D5	DEVCLKA+/- (M->C)	Primary carrier-bound reference clock required for FPGA gigabit transceivers. Equivalent to device clock.
Device Clock, SYSREF, and SYNC			
FMC Signal Name	FMC Pin	Standard JESD204 Application Mapping	Description
CLK_LA0_P/N	G6/G7	DEVCLKB+/- (M->C)	Secondary carrier-bound device clock. Used for special FPGA functions such as sampling SYSREF.
D8/D9	D8/D9	DEVCLK+/- (C->M)	Mezzanine-bound device clock. Used for low noise conversion clock.
CAR_SYSREFP/M	G9/G10	SYSREF+/- (M->C)	Carrier-bound SYSREF signal
D11/D12	D11/D12	SYSREF+/- (C->M)	Mezzanine-bound SYSREF signal
SYNCP/M	G12/G13	SYNC+/- (C>M)	ADC Mezzanine-bound SYNC signal for use in class 0/1/2 JESD204 systems
DAC_SYNC_P/M	F10/F11	DAC SYNC+/- (M>C)	Carrier-bound SYNC signal for use in class 0/1/2 JESD204 systems
ALT_DAC_SYNC_PM	F19/F20	Alt. DAC SYNC+/- (M>C)	Alternate Carrier-bound SYNC signal for use in class 0/1/2 JESD204B systems
ALT_SYNCP/M	H31/H32	Alt. SYNC+/- (C>M)	Alternate ADC Mezzanine-bound SYNC signal. For use when SYNC (C->M) is not available.
Special Purpose I/O			

Table 3. ADC/DAC EVM FMC Connector (J4) Description of the TSW14J10 (continued)

FMC Signal Name	FMC Pin	Direction	Description
F1	F1	ADC/DAC-to-FPGA	Power good from mezzanine to carrier
D1	D1	FPGA-to-ADC/DAC	Power good from carrier to mezzanine
PRESENT	H2	ADC/DAC-to-FPGA	EVM Present indicator
ADBUS5_T	C15	USB-to-ADC/DAC	USB SPI Interface signal
ADBUS6_T	D14	USB-to-ADC/DAC	USB SPI Interface signal
ADBUS7_T	D15	USB-to-ADC/DAC	USB SPI Interface signal
BDBUS4_T	G15	USB-to-ADC/DAC	USB SPI Interface signal
BDBUS5_T	G16	USB-to-ADC/DAC	USB SPI Interface signal
BDBUS6_T	H16	USB-to-ADC/DAC	USB SPI Interface signal
BDBUS7_T	H17	USB-to-ADC/DAC	USB SPI Interface signal
CDBUS4_T	C14	USB-to-ADC/DAC	USB SPI Interface signal
OVRA	K19	ADC-to-FPGA	ADC over range indicator
OVRB	E18	ADC-to-FPGA	ADC over range indicator
OVRC	J22	ADC-to-FPGA	ADC over range indicator
OVRD	J21	ADC-to-FPGA	ADC over range indicator
FPGA_CLK2P/N	J2/J3	FPGA-to-DAC	Spare clock
FPGA_CLK1P/N	K4/K5	FPGA-to-DAC	Spare clock
LED_SYNC1	C18	FPGA-to-ADC	SYNC LED indicator
SPLED0	D17	FPGA-to-ADC	Spare LED
SPLED1	D18	FPGA-to-ADC	Spare LED
C19	C19		Spare connection
C26	C26		Spare connection
C27	C27		Spare connection
D26	D26		Spare connection
E19	E19		Spare connection
G27	G27		Spare connection
G36	G36		Spare connection
G37	G37		Spare connection
H37	H37		Spare connection
H38	H38		Spare connection
K20	K20		Spare connection
K23	K23		Spare connection

3.3.3 JTAG Connector

The TSW14J10EVM includes an industry-standard JTAG connector that is connected to the DDBUS of the USB interface device. This interface allows the HSDC Pro GUI the capability to configure an FPGA on a development platform if it has a corresponding JTAG connector that is routed directly to the FPGA JTAG pins. Connect the provide JTAG cable between the TSW14J10 JTAG connector and the FPGA development board JTAG connector.

NOTE: FPGA development boards may require jumpers and or switches be placed in a certain configuration to connect the JTAG connector to the FPGA JTAG pins.

If the FPGA development platform has the JTAG signals routed on the FMC connector, jumpers JP2-5 can be set (shunt pins 2-3) to route these signals to the FMC connector instead of the JTAG connector.

3.3.4 USB I/O Connection

HSDC Pro GUI control is accomplished through USB connector J3. This will provide the interface between HSDC Pro GUI running on a PC Windows operating system and a FPGA development platform. For the computer, the drivers needed to access the USB port are included in the HSDC Pro GUI installation software. The drivers are automatically installed during the installation process. On the TSW14J10EVM, the USB port is used to identify the type and serial number of the EVM under test, load the desired FPGA configuration file, capture ADC EVM data from the FPGA, and send test pattern data to the FPGA for DAC EVM testing.

4 Software Start Up

4.1 Installation Instructions

Download the latest version of the HSDC Pro GUI ([slwc107x.zip](#)) to a local directory on a host PC. This can be found on the TI website by entering "HIGH SPEED DATA CONVERTER PRO GUI INSTALLER" or "TSW14J10EVM" in the search parameter window at [www.ti.com](#).

Unzipping the software package generates a folder called *High Speed Data Converter Pro - Installer vx.xx.exe*, where x.xx is the version number. Run this program to start the installation

Follow the on-screen instructions during installation.

NOTE: If an older version of the GUI has already been installed, make sure to uninstall it before loading a newer version.

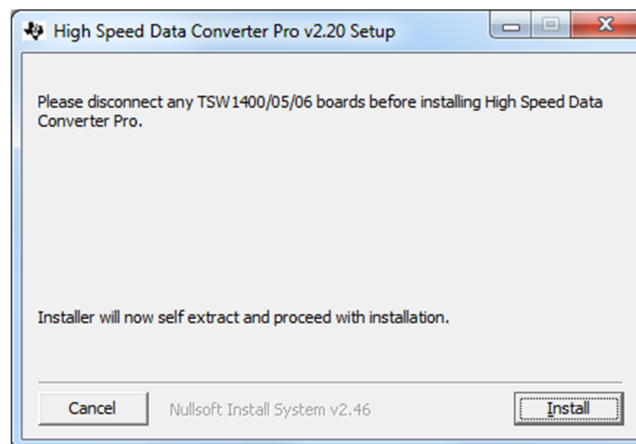

Figure 3. GUI Installation

Make sure to disconnect all USB cables from any TSW14xxx boards before installing the software.

Click on the **Install** button. A new window opens. Click the **Next** button.

Accept the License Agreement. Click on **Next** to start the installation. After the installer has finished, click on **Next** one last time.

The installation is now complete. The GUI executable and associated files will reside in the following directory.

"C:\Program Files (x86)\Texas Instruments\High Speed Data Converter Pro"

When new TI High Speed Data Converter EVM's or JESD204B interface modes become available that are not currently supported by the latest release of HSDC Pro GUI, the HSDCProv_xpXX_Patch_setup executable, available on the TI website under the High Speed Data Converter Pro Software product folder (<http://www.ti.com/tool/dataconverterpro-sw>), will allow the user to add these to the GUI device list. After the patch has been downloaded, follow the on screen instructions to run the patch. The software will display the files that will be added. After running the patch, go ahead and open HSDC Pro and the new parts and modes will appear in the ADC and DAC device drop down selection box. The patch is always specific to a core GUI version and will not work for a GUI version that the patch was not explicitly created for.

4.2 USB Interface and Drivers

Connect a USB cable between J3 of the TSW14J10EVM and a host PC.

Click on the High Speed Data Converter Pro icon that was created on the desktop panel or go to "C:\Program Files (x86)\Texas Instruments\High Speed Data Converter Pro" and double click on the executable called *High Speed Data Converter Pro.exe* to start the GUI.

The GUI first attempts to connect to the EVM USB interface. If the GUI identifies a valid board serial number, a pop-up opens displaying this value, as shown in Figure 4. It is possible to connect several TSW14J10 EVMs to one host PC but the GUI can only connect to one at a time. In the case where multiple boards are connected to the PC, the pop-up will display all of the serial numbers found. The user then selects which board the GUI will be associated with.

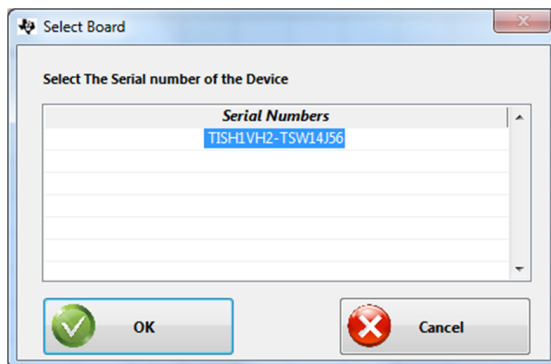

Figure 4. TSW14J10EVM Serial Number

Click on the **OK** button to connect the GUI to the board. The top-level GUI opens and appears as shown in Figure 5.

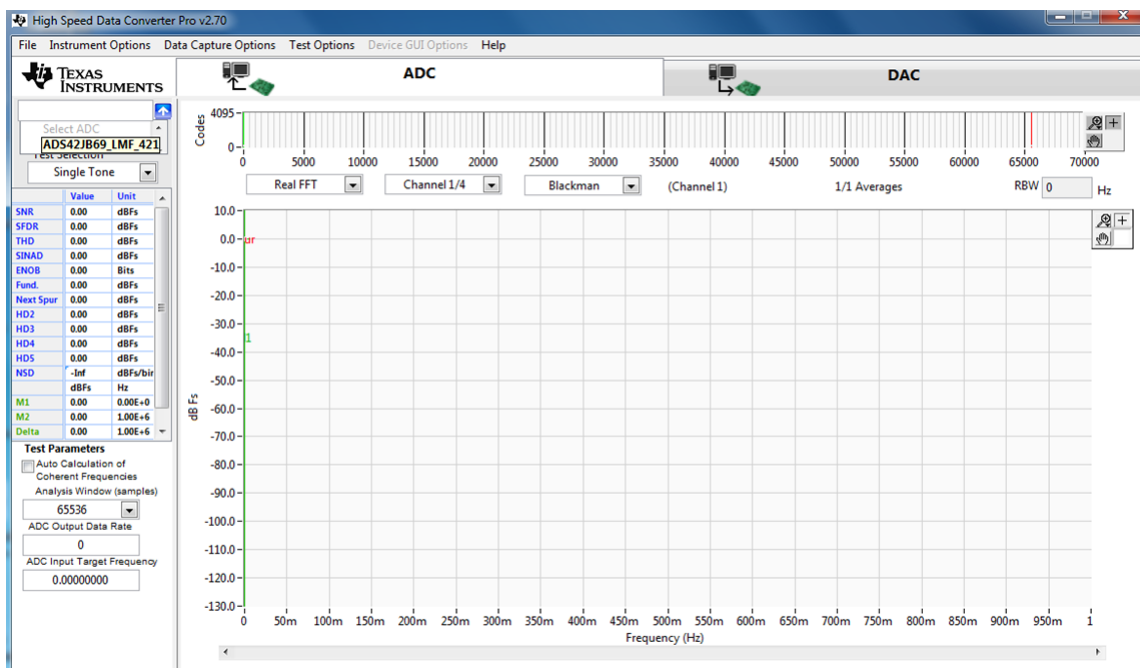

Figure 5. High Speed Data Converter Pro GUI Top Level

If the message *No Board Connected* opens, double check the USB cable connection. If the cable connection appears fine, try establishing a connection by clicking on the *Instrument Option* tab at the top left of the GUI and select *Connect to the Board*. If this still does not correct this issue, check the status of the host USB port.

When the software is installed and the USB cable has been connected to the TSW14J10EVM and the PC, the TSW14J10 USB serial converter should be located in the Hardware Device Manager under the Universal Serial Bus controllers as shown in [Figure 6](#). This is a quad device which is why there is an A, B, C, and D USB serial converter shown. When the USB cable is removed, these four will no longer be visible in the Device Manager. If the drivers are present in the Device Manager window and the software still does not connect, cycle power to the board and repeat the previous steps.

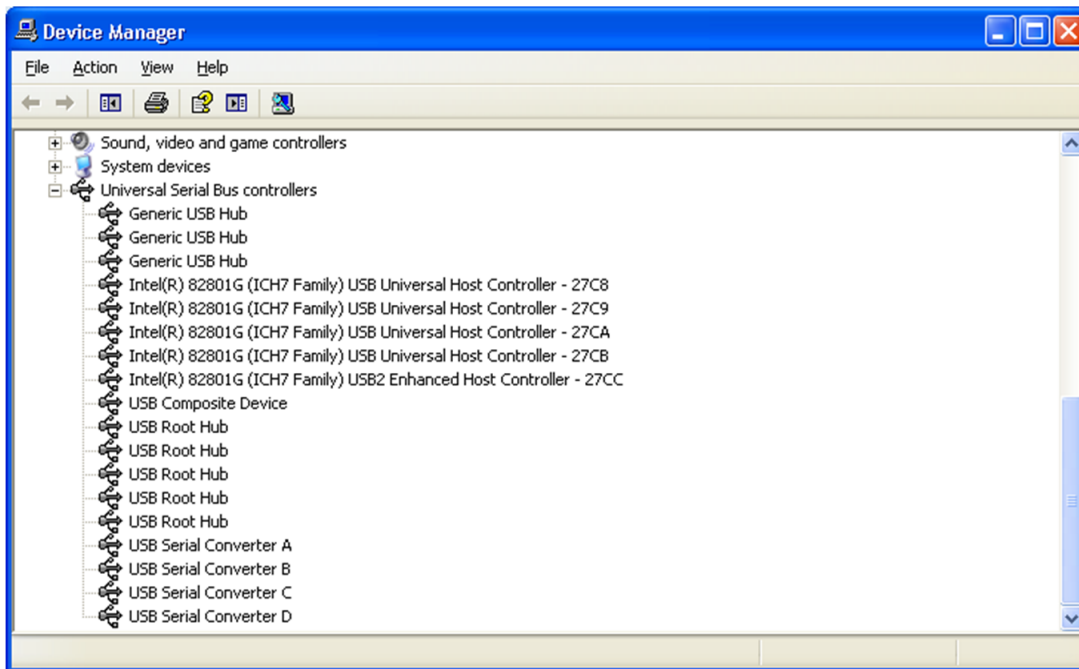

Figure 6. Hardware Device Manager

5 Downloading Firmware Example

If the FPGA development platform is to be programmed using the TSW14J10EVM, either connect the provided ribbon cable between the TSW14J10 JTAG connector and the FPGA development platform JTAG connector or move the shunts on JP2–JP5 to pins 2-3 if the JTAG signals are routed to the FMC connector.

The HSDC Pro GUI software provides support for certain FPGAs and modes of operation. The firmware files needed are special .svf formatted files for Xilinx devices and .rbf formatted files for Altera devices. The files used by the GUI currently reside in the directory called "C:\Program Files (x86)\Texas Instruments\High Speed Data Converter Pro\14J10KC705 Details\Firmware" for the Xilinx Kintex KC705 board, "C:\Program Files (x86)\Texas Instruments\High Speed Data Converter Pro\14J10VC707 Details\Firmware" for the Xilinx Virtex VC707 board, and "C:\Program Files (x86)\Texas Instruments\High Speed Data Converter Pro\14J10ZC706 Details\Firmware" for the Xilinx Zync ZC706 board.

To load a Xilinx KC705 development platform firmware after the GUI has established connection (setup as shown in [Figure 1](#)), click on the *Select ADC* window in the top left of the GUI and select *ADS42JB69_LMF_421*, as shown in [Figure 5](#).

The GUI asks if you want to update the Firmware for the ADC. Click on Yes. The GUI starts loading the firmware from the PC to the Xilinx Kintex 7 FPGA. While the firmware is loading, the GPIO LED's on the FPGA platform will all be on. This process takes about 2 minutes. Once completed, the INIT LED (DS21) and DONE LED (DS20) will illuminate on the KC705. After the ADS42JBx9EVM is programmed, the KC705 GPIO LED status will be as follows:

- 0 – On (DAC SYNC indicator)
- 1 – On (ADC SYNC indicator)
- 2 – Off (JESD reset)
- 3 – On (ADC JESD mode enabled)
- 4 – Off (DAC JESD mode enabled)
- 5 – Blinking (System clock divided down)
- 6 – Blinking (JESD Core clock divided down)
- 7 – Blinking (Reference clock divided down)

These same status LED's apply to the Xilinx VC707 development platform. For the Xilinx Zync ZC706 platform, only three status LED's are used. After this board is programmed and running with an ADC or DAC, the status of the GPIO LED's will be as follows:

- L - Blinking (Reference clock divided down)
- C - Blinking (JESD Core clock divided down)
- R - Blinking (System clock divided down)

If the ADS42Jx9EVM is not programmed, the GPIO LED status is as follows:

- 0 – On (DAC SYNC indicator)
- 1 – Off (ADC SYNC indicator)
- 2 – On (JESD reset)
- 3 – Off (ADC JESD mode enabled)
- 4 – Off (DAC JESD mode enabled)
- 5 – Blinking (System clock divided down)
- 6 – N/A (JESD Core clock divided down)
- 7 – N/A (Reference clock divided down)

If the two boards are not synchronized after both have been configured, this is indicated by GPIO LED 2 being *Off* on the KC705 board and D3 being *On* on the ADS42JB69EVM. Pressing the CPU reset (SW7) on the KC705 board resets the JESD204B link and should synchronize the two boards. After synchronization has been established, enter a valid sampling rate in the HSDC Pro GUI and click on *Capture* to display valid data from the ADC EVM.

For information regarding the use of the TSW14J10EVM with a TI ADC or DAC JESD204B serial interface EVM, consult the High Speed Data Converter Pro GUI User's Guide ([SLWU087](#)) along with the individual EVM User's Guide.

6 DAC and ADC GUI Configuration File Changes When Using a Xilinx Development Platform

The configuration files that come with the TI ADC and DAC EVM GUIs are setup to operate with the Altera-based TI TSW14J56EVM. These files will work with the TSW14J10EVM when using a Xilinx platform but need a couple of changes to the settings of the LMK04828 registers. The firmware for the Xilinx Development Platforms use a separate clock input for REFCLK and Core clock to give maximum flexibility and support all line rates and subclasses with a single programmable design. The Xilinx IP used in the firmware can be driven by a single clock in many circumstances (see the clocking section of the Xilinx IP product guide for more details).

The REFCLK and Core clock are determined by the following lane rate conditions:

REFCLK = Lane rate / 10, and Core clock = Lane rate / 10 when lane rate is between 1 G and 3.2 G

REFCLK = Lane rate / 20 and Core clock = Lane rate / 40 when lane rate is between 3.2 G and 10.3125 G*

Note: The GTEX2 transceivers with speed grade -2 devices used on the Xilinx development platforms have a maximum rate of 10.3125 Gbps. In addition, the KC705 transceivers have a frequency band gap from 8 Gbps to 9.8 Gbps.

The ADC and DAC GUIs do not always use the same LMK04828 outputs for these two clocks. The output from the LMK04828 connected to FMC connector pins D4 and D5 will be the REFCLK. The output from the LMK04828 connected to FMC connector pins G6 and G7 will be the Core clock. Consult the EVM schematic to verify the outputs.

On the KC705 platform, only 4 TX and 4 RX JESD204B lanes were routed to the HPC FMC connector. On the VC707 and ZC706, there are at least 8 RX and TX lanes routed. The Xilinx firmware designed to be used with the TSW14J10EVM running HSDC Pro GUI uses internal FPGA memory only. Due to both of these constraints, the user must be careful when selecting the number of samples and number of lanes to be used in both ADC and DAC testing. The total memory and JESD204B lanes that are available are as follows:

KC705 4 lanes RX and TX 128K total samples

VC707 8 lanes RX and TX 256K total samples

ZC706 8 lanes RX and TX 128K total samples

For example when using the KC705, if the user is capturing data from a dual ADC, the most lanes that can be used is 4 and the highest value that can be entered for number of samples in HSDC Pro GUI will be 64K.

6.1 DAC38J84EVM with Xilinx VC707 Development Board Setup Example

This section provides an example of the TSW14J10EVM being used to test the DAC38J84EVM with a Xilinx VC707 development platform as shown in Figure 7. This example shows what must be modified in the DAC3XJ8X GUI for a setup using 4 lanes (LMFS = 4421), 1x interpolation, and a DAC sample rate of 368.64M. Setup the hardware as follows:

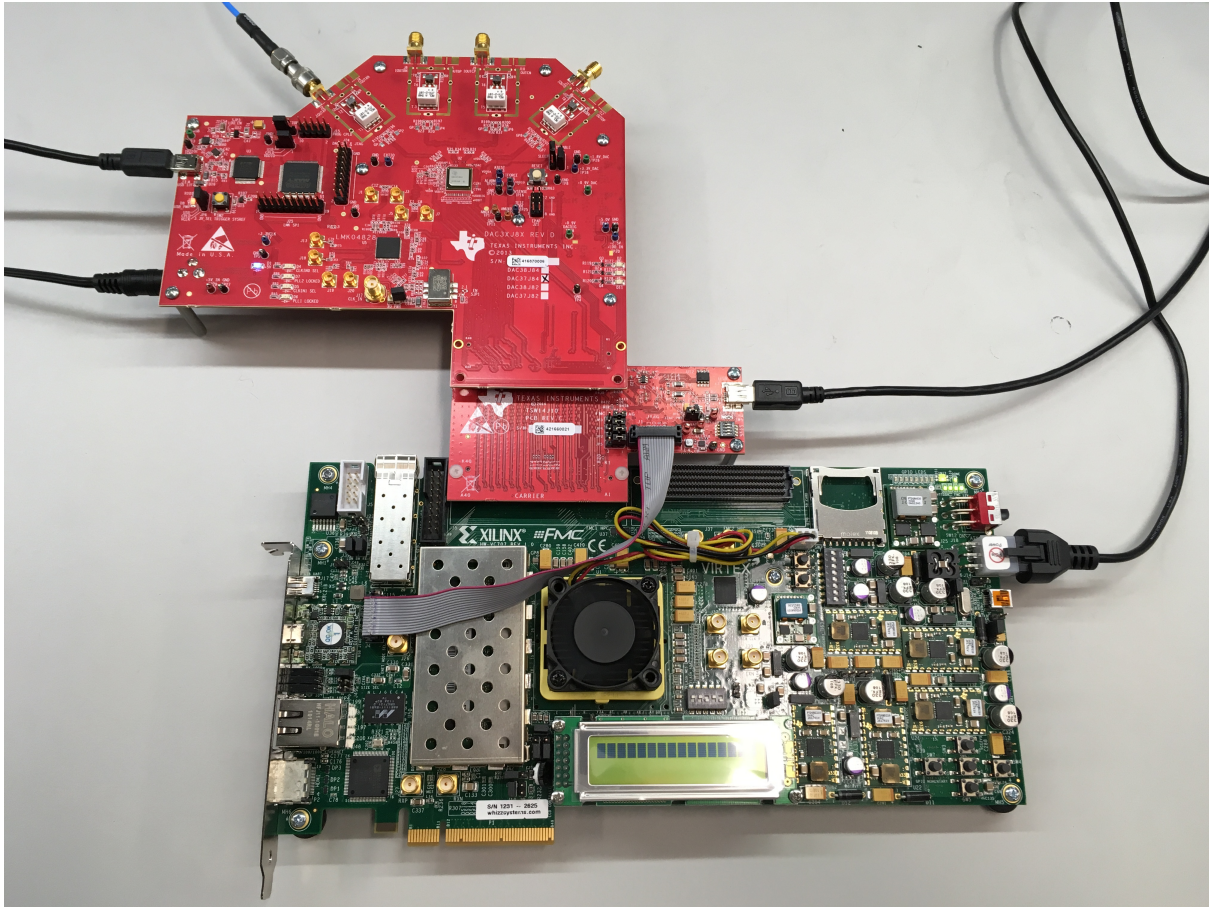

Figure 7. DAC38J84EVM GUI Setup Example

1. Connect J5 of the TSW14J10 to FMC HPC connector J35 on the VC707.
2. Connect the DAC to the other end of the TSW14J10.
3. Connect the power cables to the VC707 and DAC38J84.
4. Connect a USB cable between the TSW14J10 and a host computer with the HSDC Pro GUI loaded.
5. Connect a USB cable between the DAC38J84 and a host computer with the DAC3XJ8X GUI loaded.

Power up the DAC38J84 and VC707. Program the DAC38J84 as follows:

After opening the DAC GUI, enter the parameters as shown in [Figure 8](#).

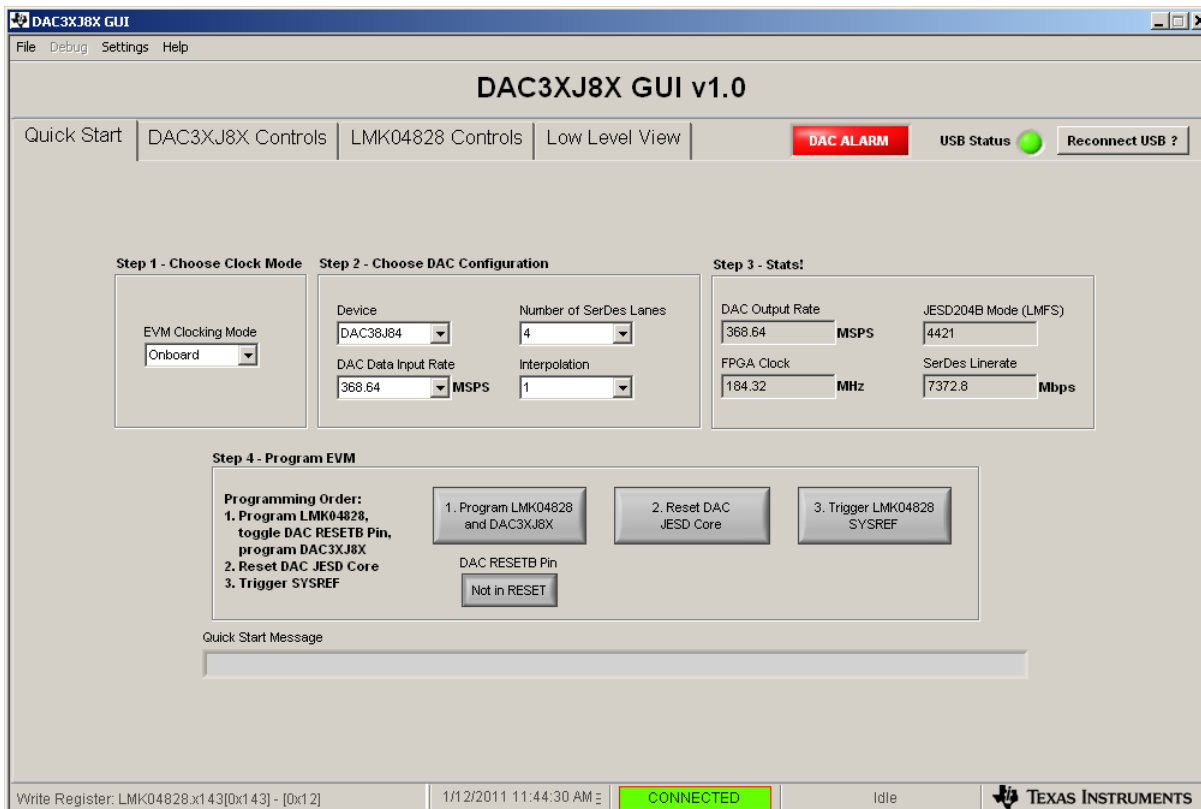

Figure 8. Quick Start Menu

The GUI calculates the lane rate and displays it in the box called *SerDes Linerate*. For this example, the lane rate is 7372.8Mbps. Using the lane rate conditions in [Section 6](#), REFCLK = 368.64 MHz and Core clock = 184.32 MHz.

Click on the *Program LMK04828 and DAC3XJ8X* button. After the programming has completed, click on the *LMK04828 Controls* tab. Next, click on the *Clock Outputs* tab.

For the DAC3XJ8X GUI, the REFCLK is provided by *CLKout 0* and the Core clock is provided by *CLKout 12*. Notice that the default setting for *CLKout 12* is *Group Powerdown*, as shown in [Figure 9](#).

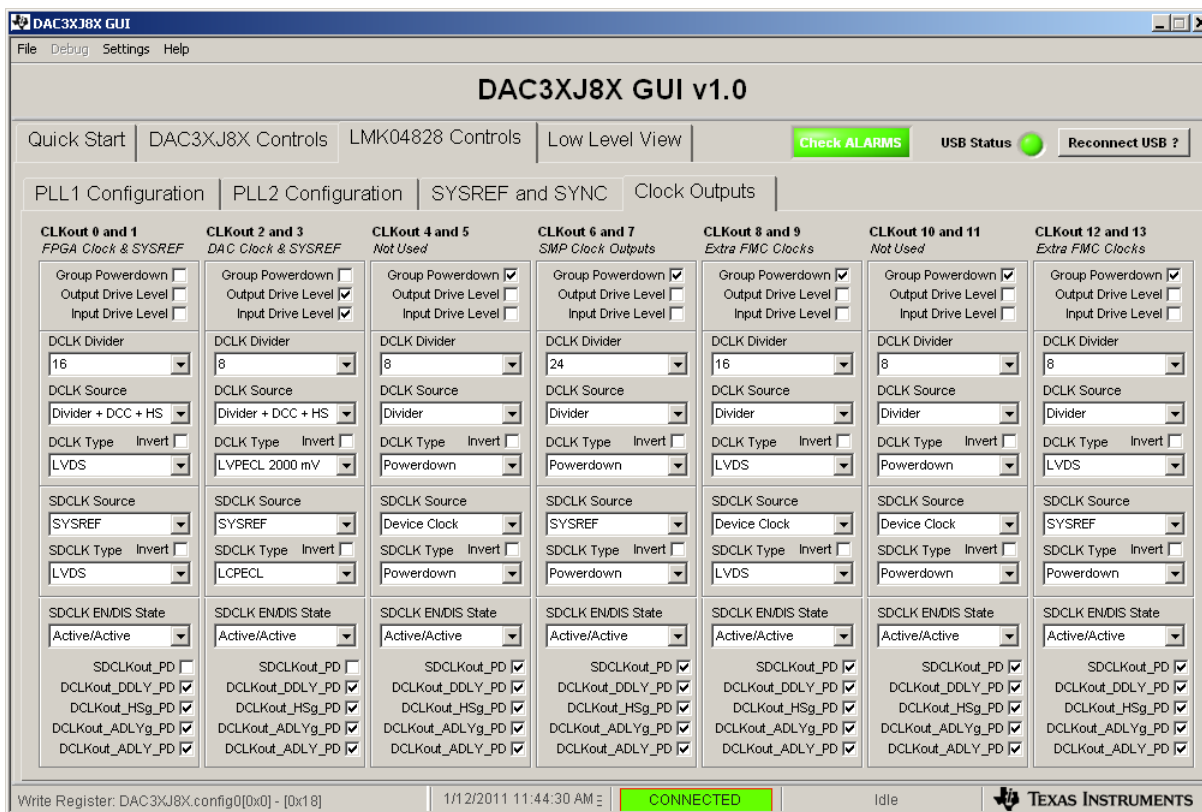

Figure 9. LMK04828 Clock Outputs Menu

Since the DAC Clock is 368.64 MHz, to provide a REFCLK of 368.64 MHz, change the *DCLK Divider* for *CLKout 0* to “8”.

To generate a Core clock of 184.32 MHz, set the *DCLK Divider* for *CLKout 12* to “16”. Also, remove the checkmark from the *Group Powerdown* box to enable this output.

The Clock Outputs menu is now as shown in Figure 10.

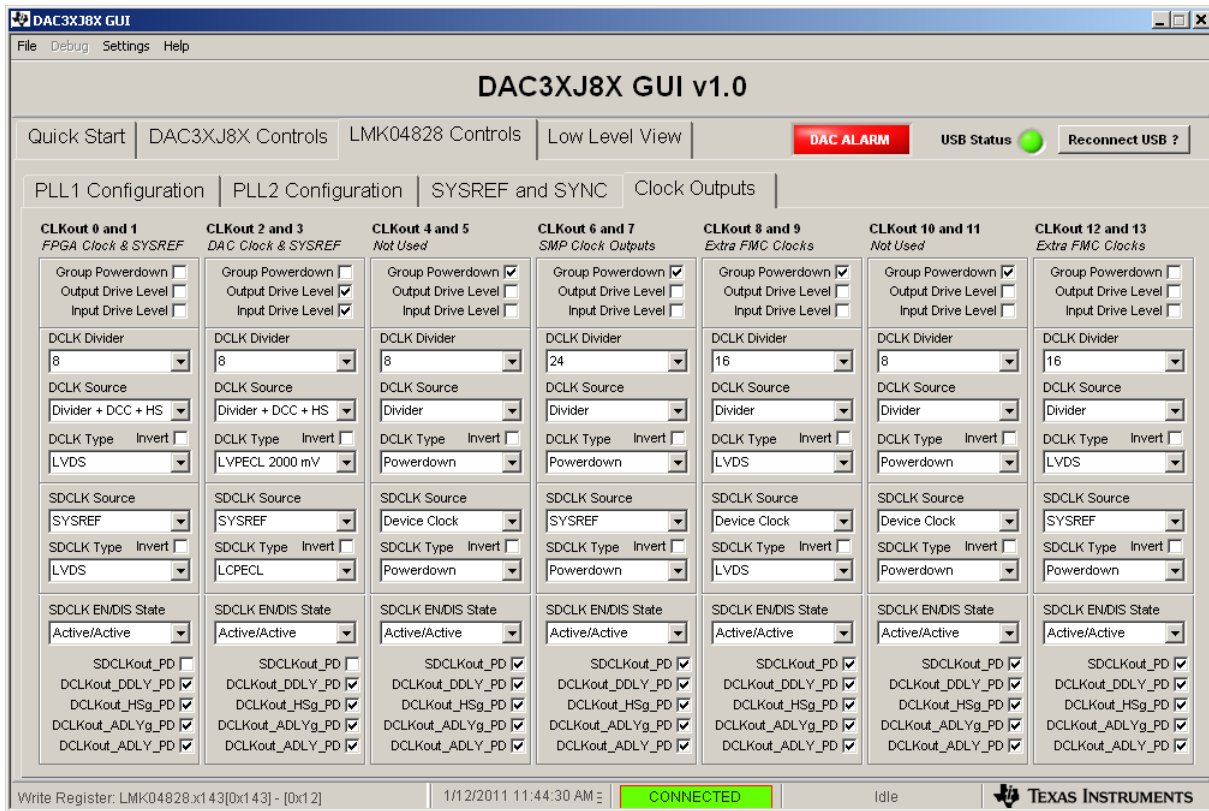

Figure 10. LMK04828 Clock Outputs Menu

Open HSDC Pro GUI, select the *DAC* tab, then select *DAC3XJ84_LMF_442* in the device button. After the firmware is loaded, enter 368.64M in the *Data Rate (SPS)* window, select 2's Complement in the *DAC Option* window and generate a 10-MHz test tone using the *IQ Multitone Generator* located in the lower left of the GUI. Click on the *Create Tones* button. The display appears as shown in [Figure 11](#).

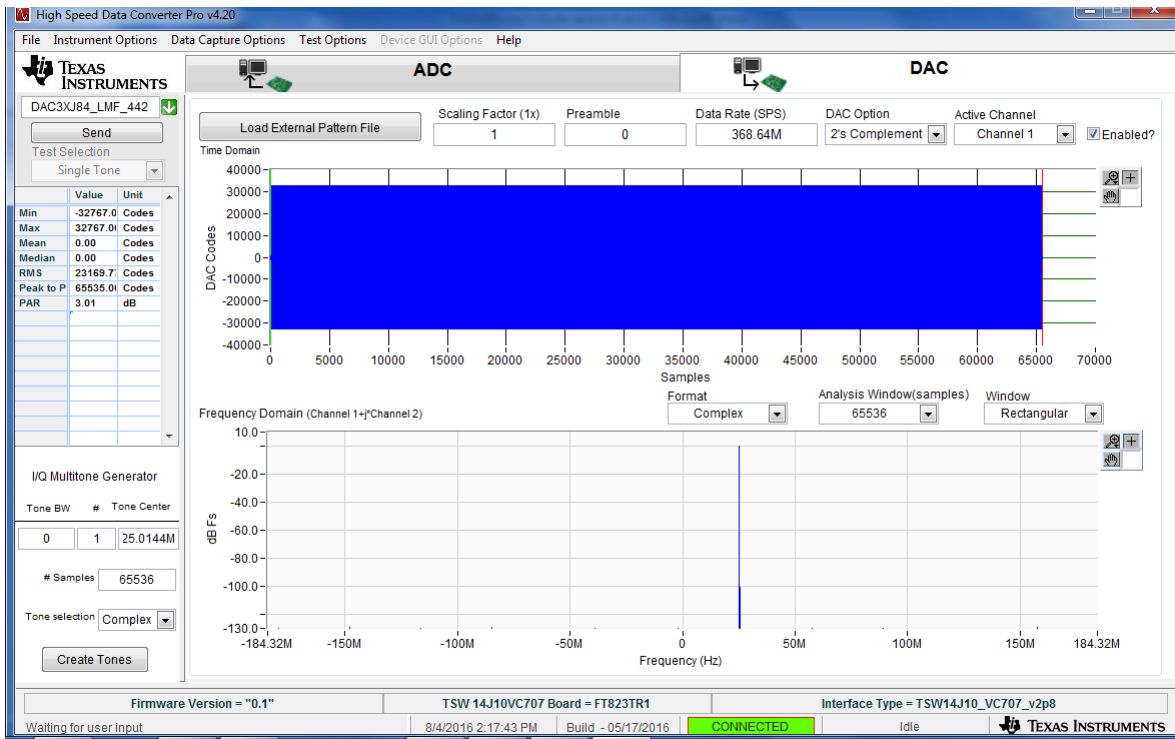

Figure 11. HSDC Pro GUI

Click the *Send* button. A new window opens showing the lane rate of the interface and the required frequency of REFCLK, as shown in [Figure 12](#).

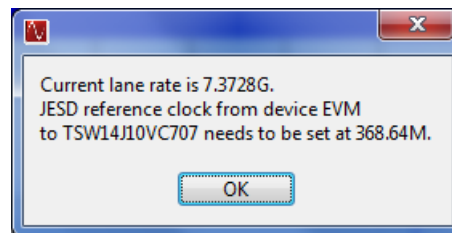

Figure 12. HSDC Pro GUI: Lane Rate and REFCLK Settings

Go back to the DAC GUI *Quick Start* tab and click the *Reset DAC JESD Core* button. Click on *Trigger LMK04828 SYSREF*.

There should now be a 10-MHz tone present at all four DAC EVM outputs.

6.2 ADC32RF45EVM With Xilinx VC707 Development Board Setup Example

The following is an example of the TSW14J10EVM being used to test the ADC32RF45EVM with a Xilinx Virtex VC707 development platform as shown in [Figure 13](#).

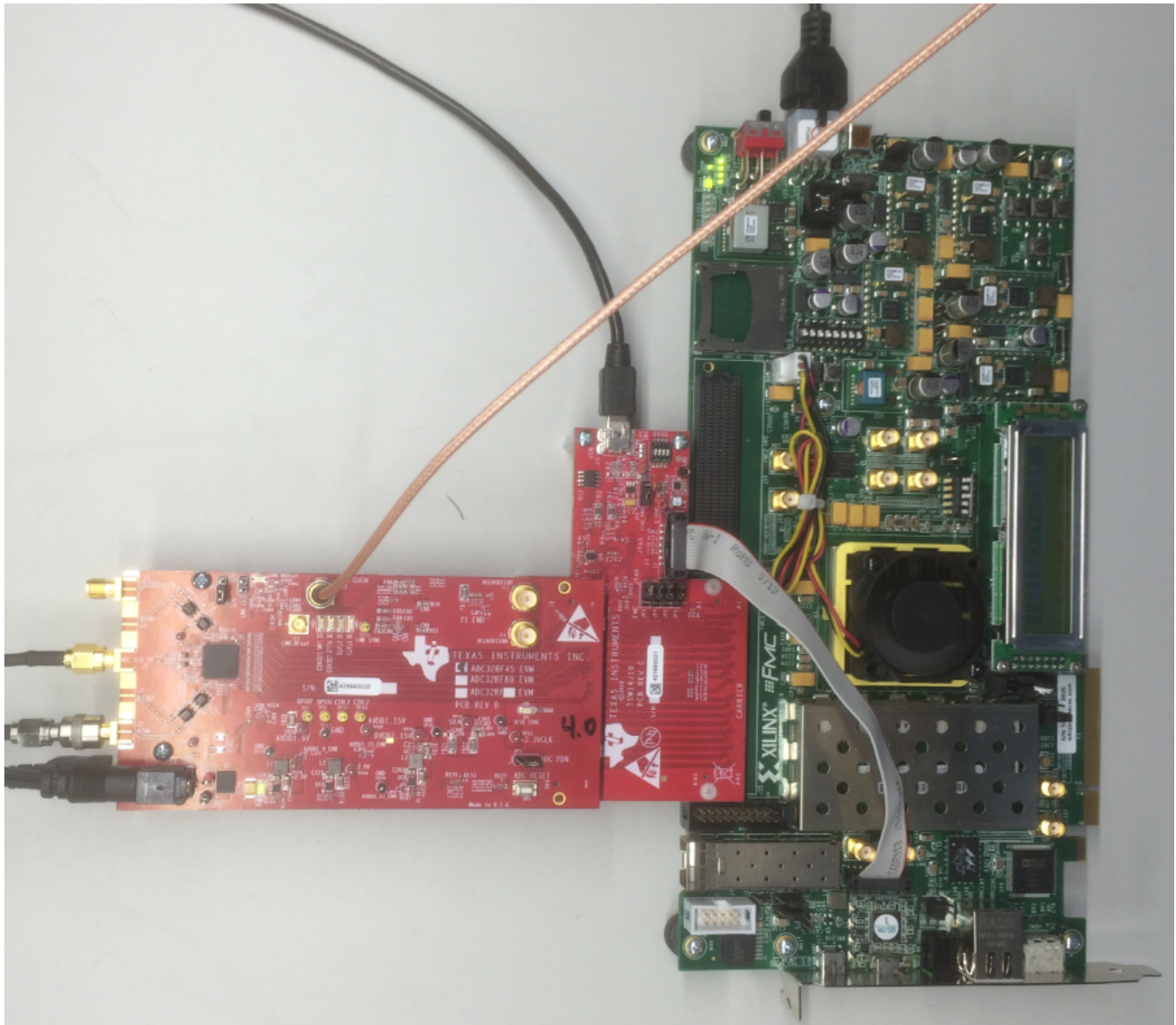

Figure 13. ADC32RF45EVM, TSW14J10EVM and VC707 Board

The following example shows what must be modified in the ADC32RF45 GUI for a setup using the JESD204B mode setting of LMFS = 82820 (8 lanes, 2 converters, 8 octets/frame, 20 samples/frame) with the ADC in bypass mode, and a sample rate of 2G.

Connect the hardware as follows:

1. Connect the TSW14J10 to FMC HPC connector FMC1 on the VC707.
2. Connect the ADC to the other end of the TSW14J10.
3. Connect the power cables to the VC707 and ADC32RF45.
4. Connect a USB cable between the TSW14J10 and a host computer with HSDC Pro GUI loaded.
5. Connect a USB cable between the ADC32RF45 and a host computer with ADC32RFxx GUI loaded.
6. Provide a 600-MHz, 12-dBM filtered IF source to AINP SMA J2.

Setup the hardware per the *ADC32RFxx EVM User's Guide (SLAU620)* in the section titled *ADC32RFxx Quick-Start Procedure (5-Sample Mode)* but use two synchronized external 2-GHz clock sources for the input to J7 and J5.

Configure the ADC32RF45EVM for LMFS = 82820 mode, per steps 1–9 of the *ADC32RFxx EVM User's Guide* using the ADC32RFxx GUI.

After the ADC32RFxx EVM has been configured, click on the *LMK04828* tab. Next, click on the *Clock Outputs* tab. The GUI appears as shown in [Figure 14](#).

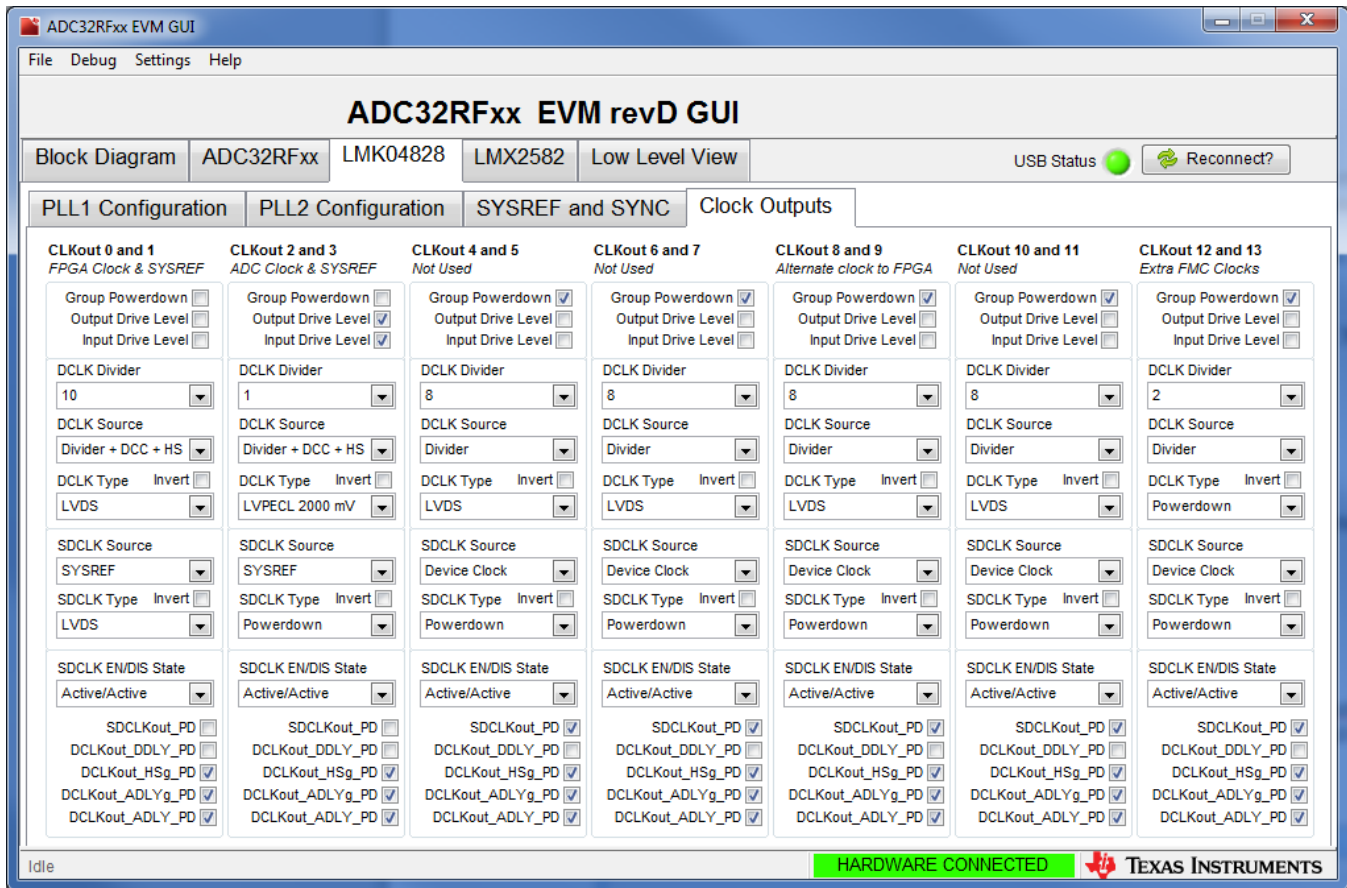

Figure 14. ADC32RFxx GUI LMK0828 Clock Outputs Tab

For this example, the lane rate is 8 Gbps. Using the equation in [Section 6](#) for lane rates greater than 3.2 Gbps:

$$\begin{aligned} \text{Reference clock} &= \text{Lane Rate} / 20 & 8\text{G} / 20 &= 400 \text{ MHz} \\ \text{Core clock} &= \text{Lane Rate} / 40 & 8\text{G} / 40 &= 200 \text{ MHz} \end{aligned}$$

In the ADC32RFxx GUI, the ADC REFCLK and SYSREF are provided by CLKout 2 and 3. The FPGA Reference clock and SYSREF are provided by CLKout 0 and 1. The FPGA Core clock (for Xilinx platforms only) is provided by CLKout 12. Notice that the default setting for CLKout 12 is *Group Powerdown*.

To generate a Reference clock = 400 MHz, set the DCLK Divider to 5 for CLKout 0. To generate a Core clock = 200 MHz, set the DCLK Divider to 10 for CLKout 12 and unselect the *Group Powerdown* option for this clock. The GUI will now appear as shown in [Figure 15](#).

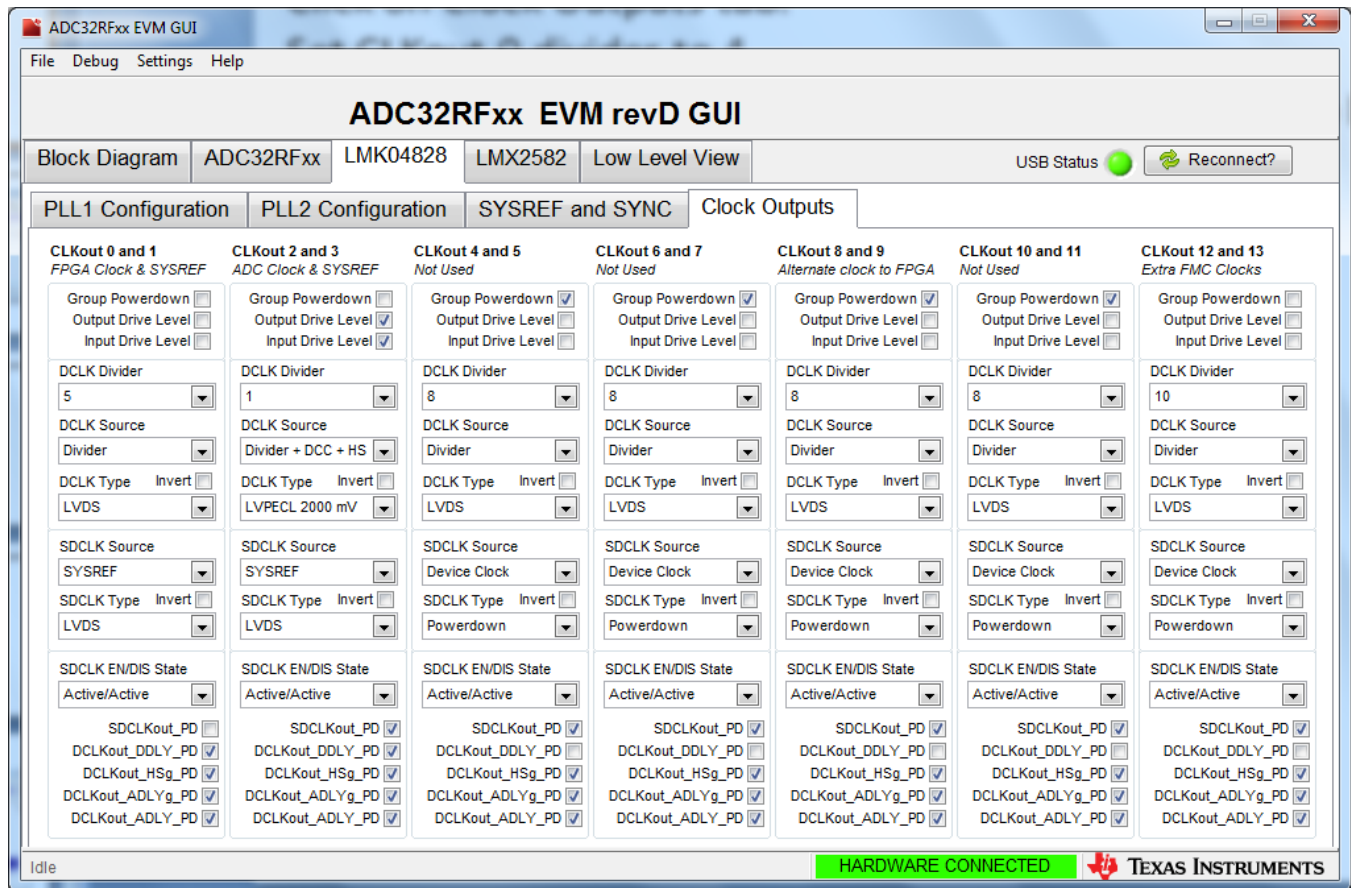

Figure 15. Updated LMK0828 Clock Outputs Tab

Open HSDC Pro GUI, select the ADC tab, and then select “ADC32RF45_LMF_82820” using the device drop-down arrow. After the firmware is loaded, enter “32768” in the *Analysis Window (samples)*. Next enter “2G” in the *ADC Output Data Rate* window. The GUI will display the new lane rate and JESD reference clock required by the capture platform FPGA, as shown in Figure 16. Click the **OK** button.

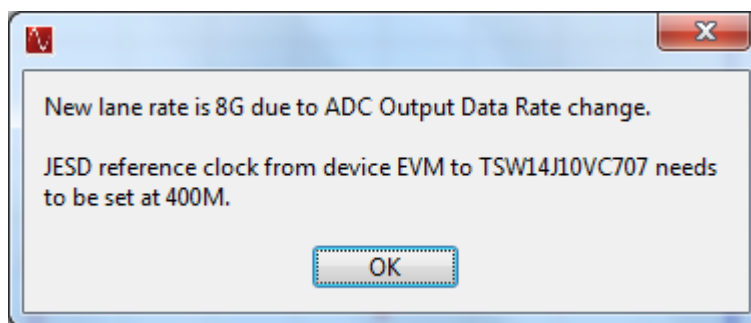

Figure 16. HSDC Pro GUI

Click the **Capture** button. The captured results should look as shown in Figure 17.

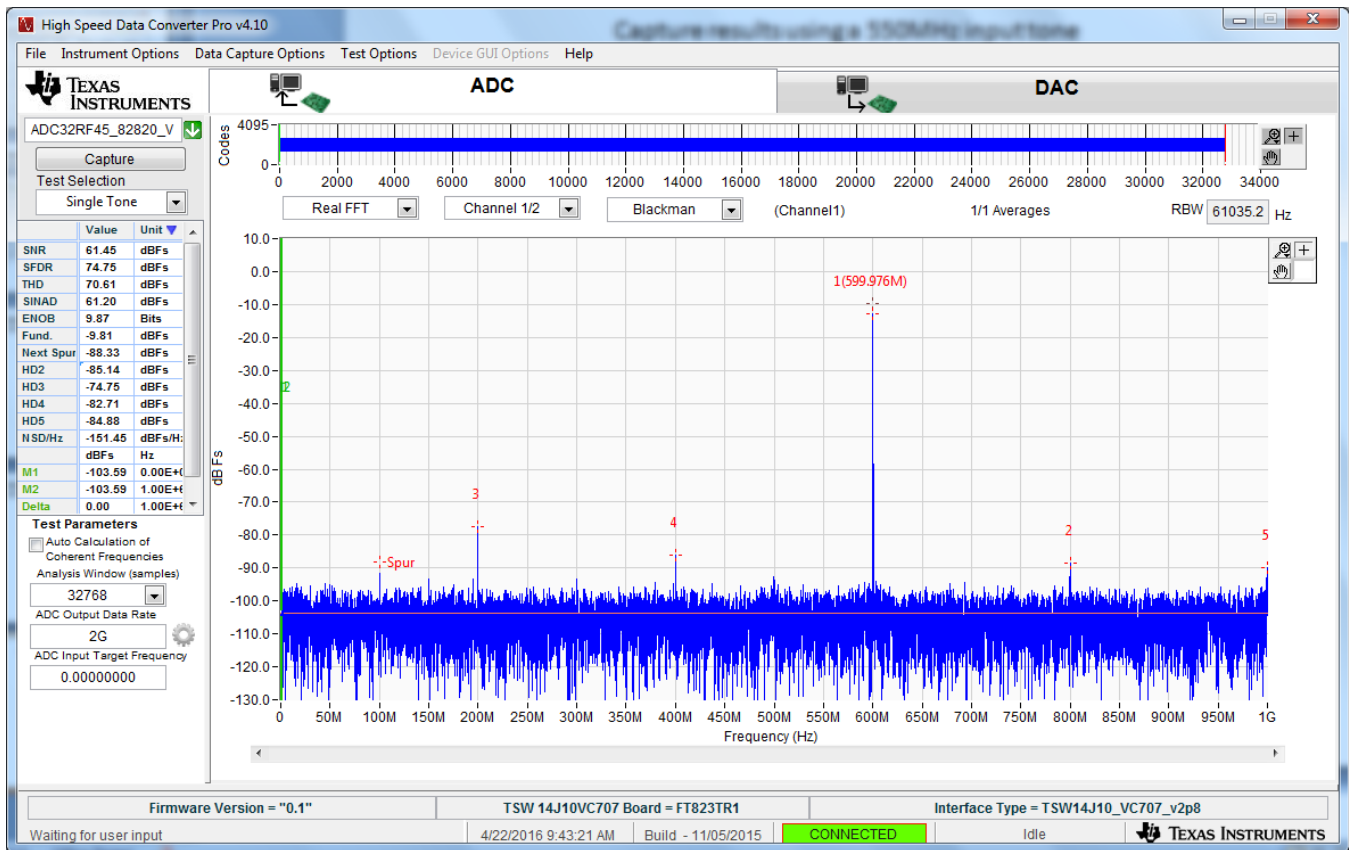

Figure 17. Captured Results for Channel A

6.3 ADC12J4000EVM With Xilinx VC707 Development Board Setup Example

The following is an example of the TSW14J10EVM being used to test the ADC12J4000EVM with a Xilinx Virtex VC707 development platform as shown in [Figure 18](#).

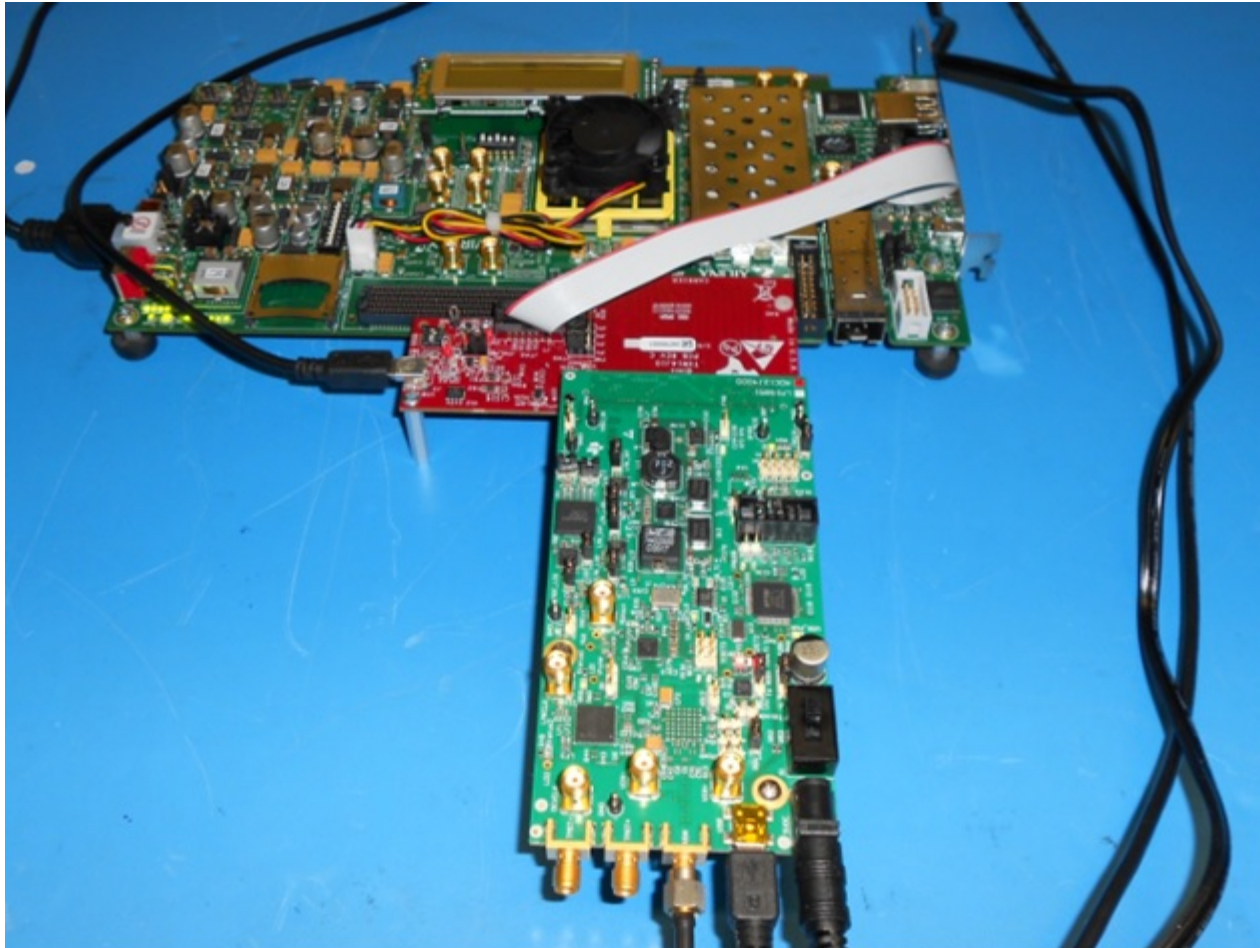

Figure 18. ADC12J4000EVM, TSW14J10EVM and VC707 Board

The following example shows the required modifications in the ADC12J4000 GUI for a setup using the JESD204B mode setting of LMFS = 8885 (8 lanes, 8 converters, 8 octets/frame, 5 samples/frame) with the ADC in bypass mode, and a sample rate of 4G.

Setup the hardware per [Section 6.2](#) but using the ADC12J4000EVM. Setup the hardware per the *ADC12J4000EVM User's Guide (SLAU551)*, internal clock mode, but use a 600-MHz IF connected to V_{IN} .

Use the ADC12J4000EVM GUI A, shown in [Figure 19](#), and follow steps 3.4–3.9 and 3.11 in the *ADC12J4000EVM User's Guide* to configure the ADC EVM.

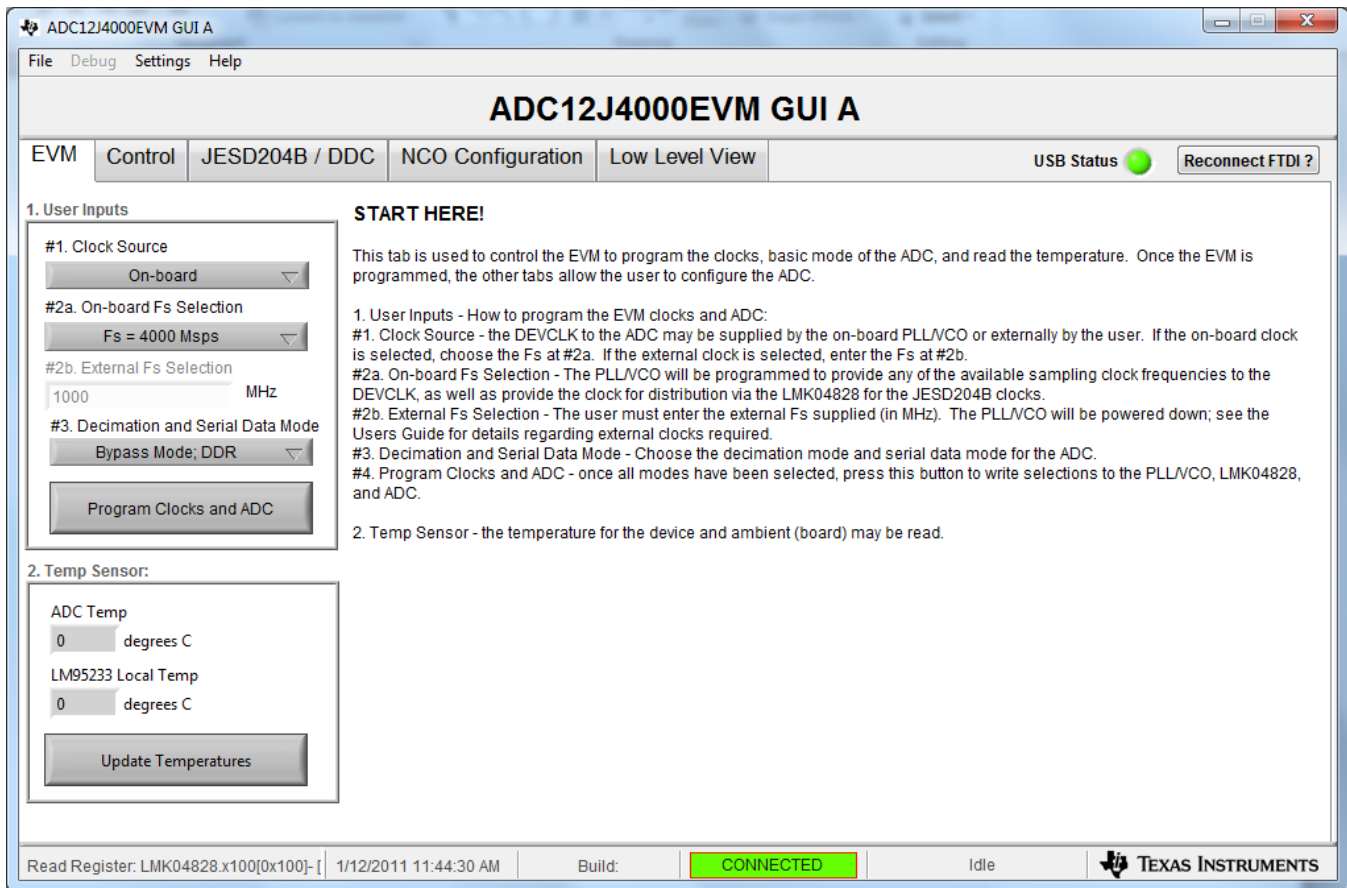

Figure 19. ADC12J4000EVM GUI

For this example, the lane rate is 8 Gbps. Using the equation in Section 6 for lane rates greater than 3.2 Gbps:

$$\begin{aligned} \text{Reference clock} &= \text{Lane Rate} / 20 & 8\text{G} / 20 &= 400 \text{ MHz} \\ \text{Core clock} &= \text{Lane Rate} / 40 & 8\text{G} / 40 &= 200 \text{ MHz} \end{aligned}$$

Since the LMK04828 input clock (2 GHz) is the ADC sample clock divided by 2, to achieve the proper frequency for the reference clock, this must be divided by 5. To achieve the proper core clock frequency, this must be divided by 10.

After the ADC12J4000 EVM has been configured, in the GUI, click on the *Low Level View* tab and perform the following writes to provide the proper divider for the LMK04828 outputs used by the Xilinx FPGA:

1. Go to LMK04828 address 0x110 and enter a “5” in the write data box and click the **Write Register** button.
2. Click the **Read Register** button and verify a “5” is read back.
3. Go to address 0x100, do a **Read Register** and verify the value “A” is read back. If not, write this value to this address.

Figure 20. LMK04828 Address 0x100

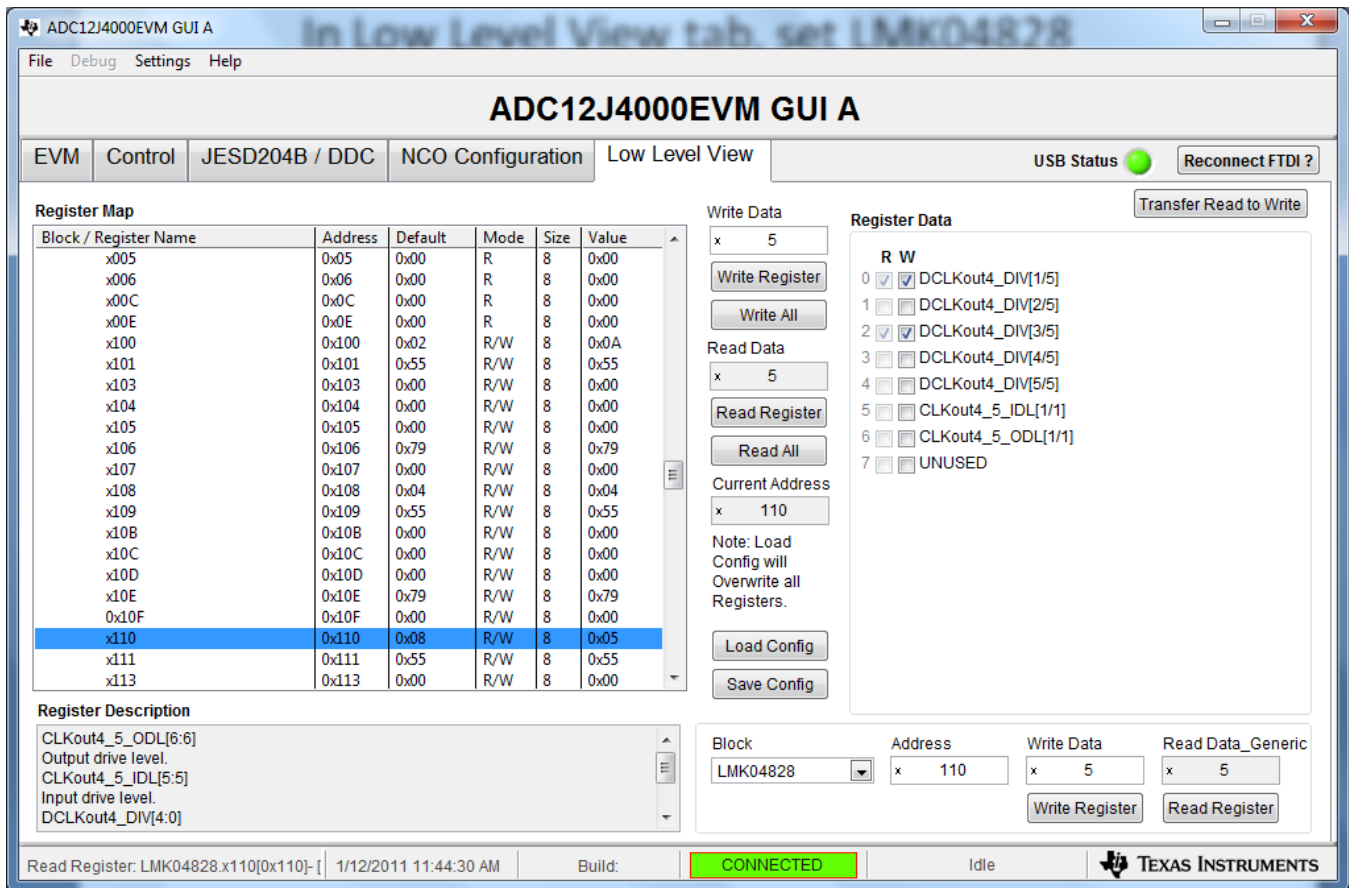

Figure 21. LMK04828 Address 0x110

Open the HSDC Pro GUI, select the ADC tab, then select “ADC12J4000_BYPASS” using the device drop-down arrow. After the firmware is loaded, make sure the *Analysis Window (samples)* is no greater than 65,536 (due to the limit of the internal FPGA memory used for this capture). Next enter "2G" in the *ADC Output Data Rate* window.

Click the **Capture** button.

The GUI will display the new lane rate and JESD reference clock required by the capture platform FPGA, as shown in Figure 22.

Click the **OK** button.

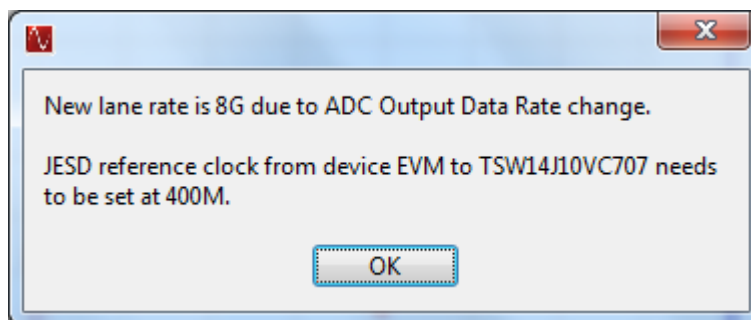

Figure 22. HSDC Pro GUI

The captured results appear as shown in Figure 23.

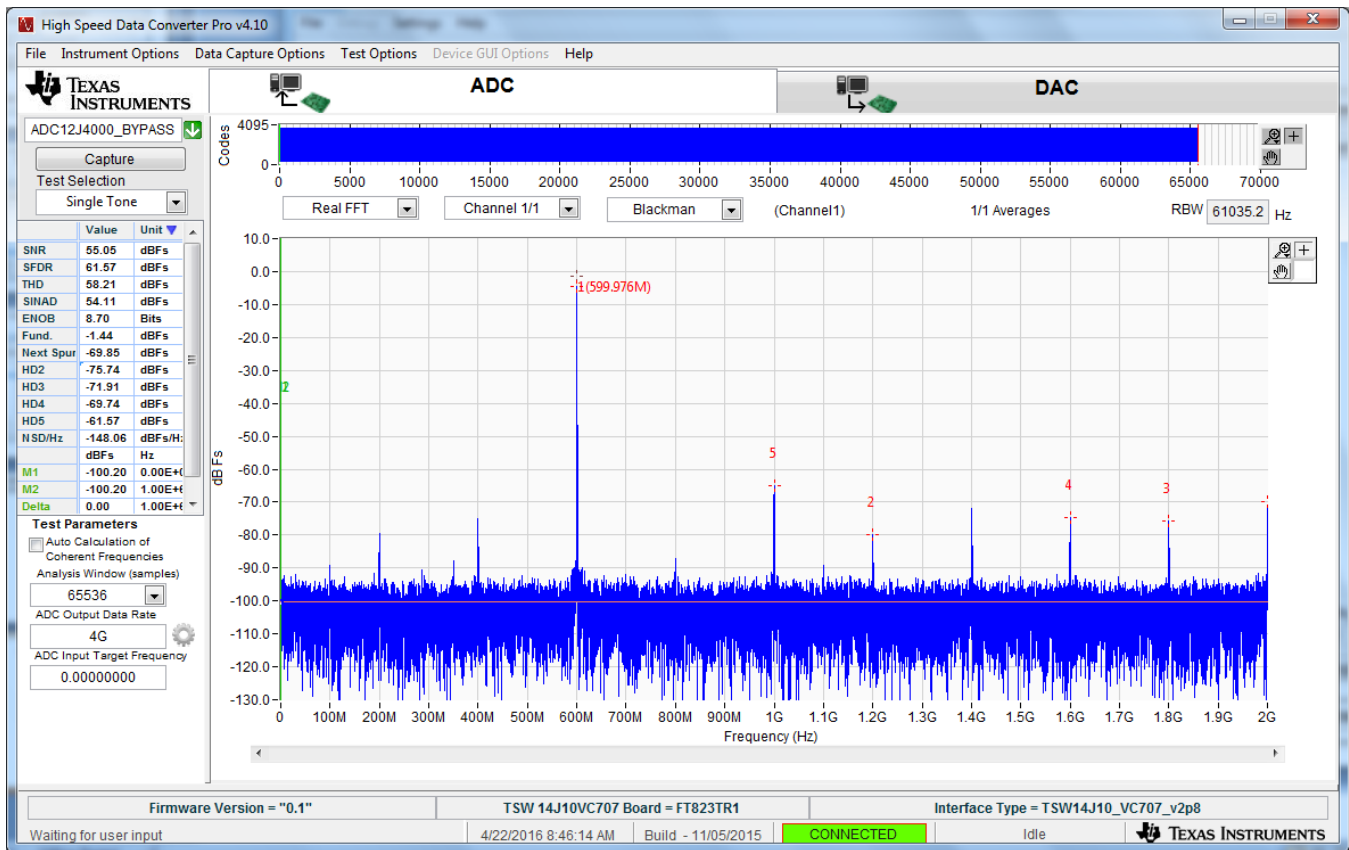

Figure 23. Captured Results for the ADC12J4000 in Bypass Mode

6.4 ADC12J4000EVM With a Xilinx Zynq ZC706 Development Board Setup Example

The following is an example of the TSW14J10EVM being used to test the ADC12J4000EVM with a Xilinx Zynq ZC706 development platform as shown in [Figure 24](#).

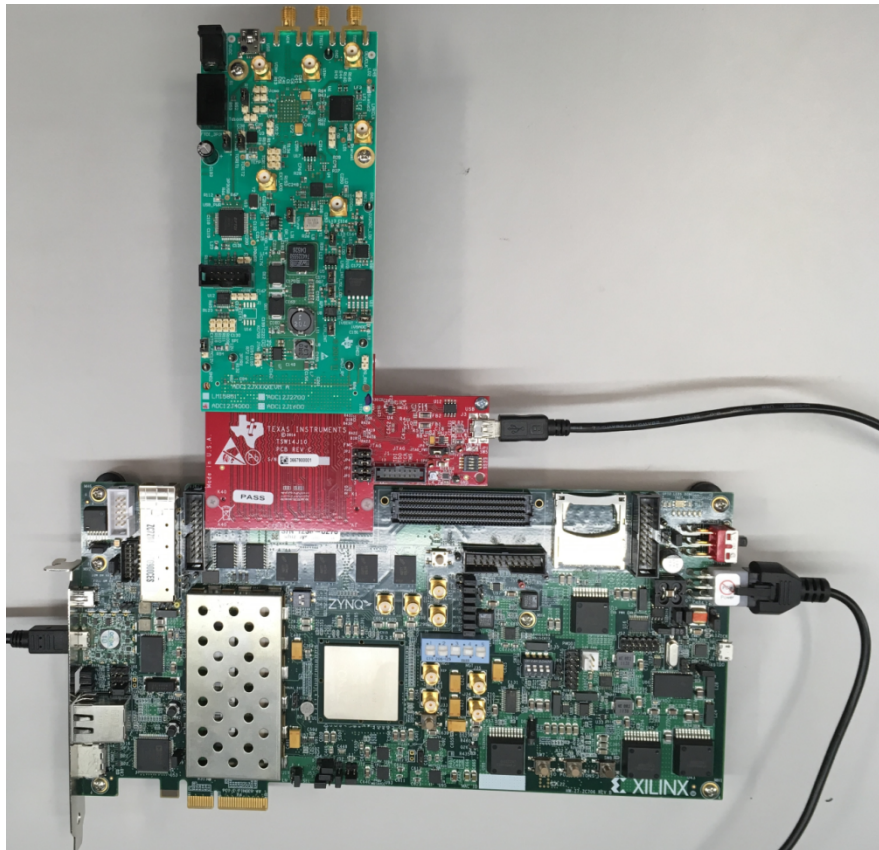

Figure 24. ADC12J4000EVM, TSW14J10EVM and ZC706 board

Since the ZC706 development board does not have a JTAG connector that can be connected to the TSW14J10EVM for programming the FPGA firmware, the bit file must be loaded using the Xilinx Vivado design tool. The first step is to program the ADC12J4000 which will provide the reference and core clocks to the ZC706.

1. Connect the TSW14J10 to the FMC HPC connector J37 on the ZC706.
2. Connect the ADC to the other end of the TSW14J10.
3. Connect the power cables to the ZC706 and ADC12J4000.
4. Connect a micro USB cable between J1 of the ZC706 and a host computer with Vivado loaded.
5. Connect a USB cable between the TSW14J10 and a host computer with HSDC Pro GUI loaded.
6. Connect a USB cable between the ADC12J4000 and a host computer with ADC12J4000 GUI loaded.

Power up the ADC12J4000 and ZC706. Program the ADC12J4000 per instructions in [Section 6.3](#).

To program the FPGA, do the following steps:

1. Due to an issue Vivado has with the file path name, move the file "TSW14J10_ZC706_2vp8.bit", located at C:\Program Files(86)\Texas Instruments\High Speed Data Converter Pro\14J10ZC706 Details\Firmware" to C:\.
2. Open the Xilinx Vivado design tool.
3. Double click on "Open Hardware Manager".
4. Click on "Open Target".
5. Select "Open New Target". Click on "Next".

6. Click on "Finish".
7. Click on "Program device". Select the device that appears.
8. Navigate to C:\
9. Select "TSW14J10_ZC706_2vp8.bit".
10. Click on "Program device".
11. A new window will open showing the status of the programming. Once this reached 100%, the FPGA is programmed and ready to be used with the TSW14J10 to run the HSDC Pro GUI.

Open the HSDC Pro GUI, select the *ADC* tab, then select "ADC12J4000_BYPASS" using the device drop-down arrow. After the firmware is loaded, make sure the *Analysis Window (samples)* is no greater than 65,536 (due to the limit of the internal FPGA memory used for this capture). Next, enter "2G" in the *ADC Output Data Rate* window.

Click the **Capture** button.

The GUI will display the new lane rate (8G) and JESD reference clock required by the capture platform FPGA (400 MHz).

Click the **OK** button.

The captured results will appear as shown in [Figure 25](#).

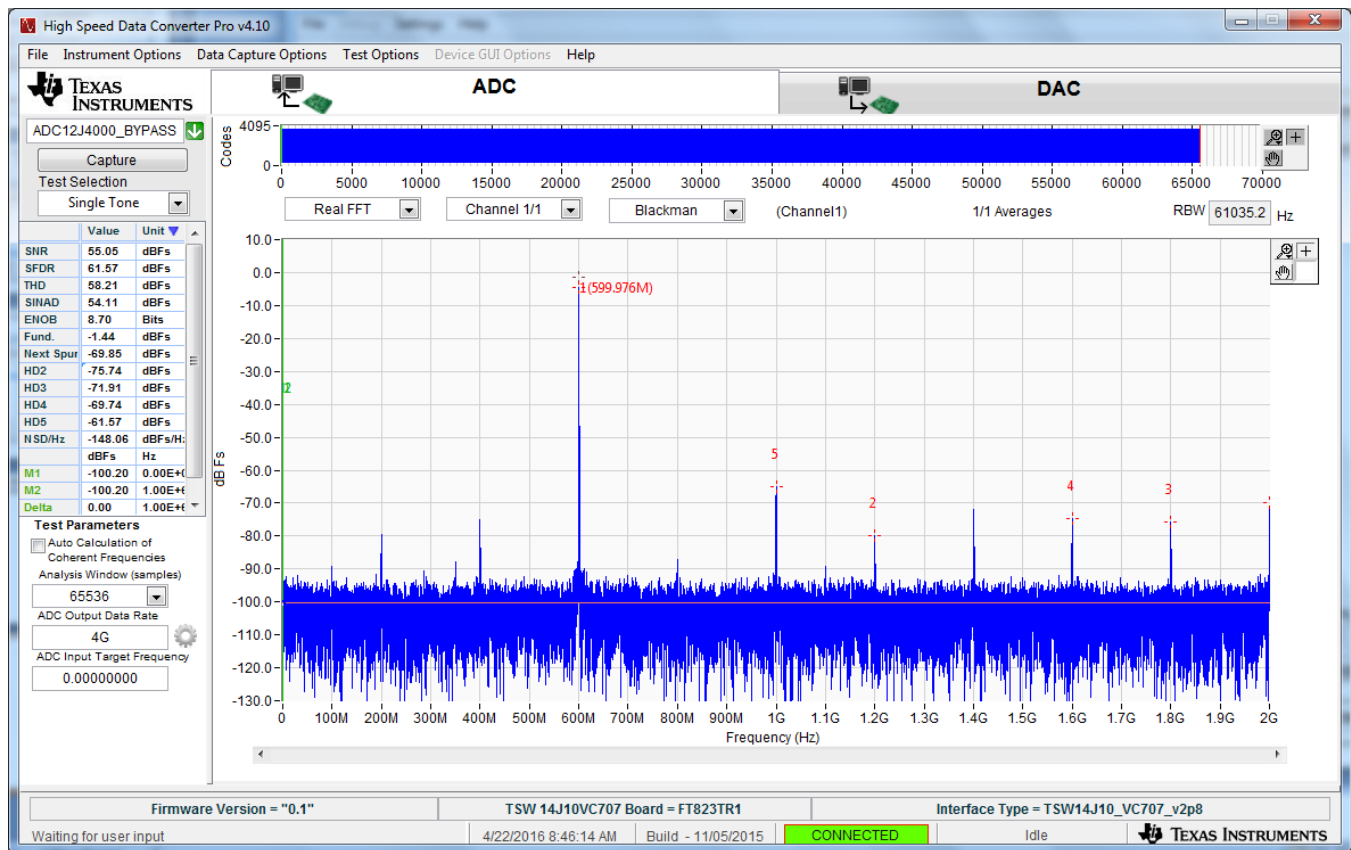

Figure 25. Captured Results for the ADC12J4000 in Bypass Mode

6.5 DAC38J84EVM With a Xilinx Zynq ZC706 Development Board Setup Example

The following is an example of the TSW14J10EVM being used to test the DAC38J84EVM with a Xilinx Zynq ZC706 development platform as shown in [Figure 26](#).

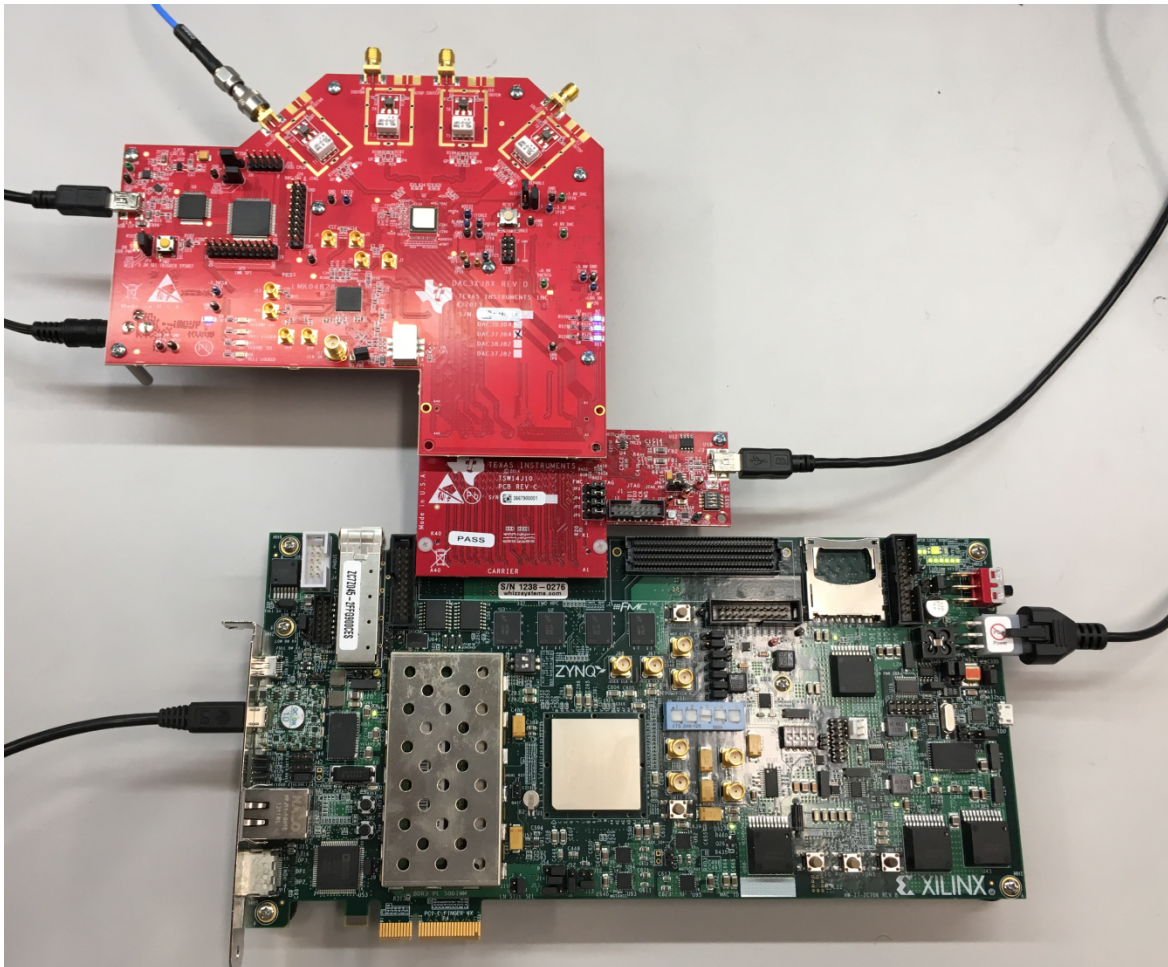

Figure 26. DAC38J84EVM, TSW14J10EVM and ZC706 Board

The ZC706 development platform does not have traces routed on FMC connector pins F10 and F11, which are normally used for the JESD204B DAC SYNC differential signals. To accommodate for this, the TSW14J10EVM has options to move the SYNC signals to FMC pins H19 and H20 by making the following resistor changes:

1. Remove R143, R145.
2. Install 0- Ω resistors for R142, R144, R146, and R149.

These resistors are all located on the bottom side of the TSW14J10EVM near the FMC connector.

NOTE: This modification is only required when testing a DAC EVM with a ZC706.

Since the ZC706 development board does not have a JTAG connector that can be connected to the TSW14J10EVM for programming the FPGA firmware, the bit file must be loaded using the Xilinx Vivado design tool. The first step is to program the DAC38J84EVM which will provide the reference and core clocks to the ZC706.

1. Connect the TSW14J10 to FMC HPC connector J37 on the ZC706.
2. Connect the DAC to the other end of the TSW14J10.
3. Connect the power cables to the ZC706 and DAC38J84.

4. Connect a micro USB cable between J1 of the ZC706 and a host computer with Vivado loaded.
5. Connect a USB cable between the TSW14J10 and a host computer with HSDC Pro GUI loaded.
6. Connect a USB cable between the DAC38J84 and a host computer with DAC3XJ8X GUI loaded.

Power up the DAC38J84 and ZC706. Program the DAC38J84 per instructions in [Section 6.1](#).

To program the FPGA, complete the following steps:

1. Due to an issue Vivado has with the file path name, move the file “TSW14J10_ZC706_2vp8.bit”, located at C:\Program Files(86)\Texas Instruments\High Speed Data Converter Pro\14J10ZC706 Details\Firmware” to C:\.
2. Open Xilinx Vivado design tool.
3. Double click on “Open Hardware Manager”.
4. Click on “Open Target”.
5. Select “Open New Target”. Click on “Next”.
6. Click on “Finish”.
7. Click on “Program device”. Select the device that appears.
8. Navigate to C:\
9. Select “TSW14J10_ZC706_2vp8.bit”.
10. Click on “Program device”.
11. A new window will open showing the status of the programming. Once this reached 100%, the FPGA is programmed and ready to be used with the TSW14J10 to run the HSDC Pro GUI.

Open HSDC Pro GUI. A new window opens indicating a connection to the ZC706, as shown in [Figure 27](#).

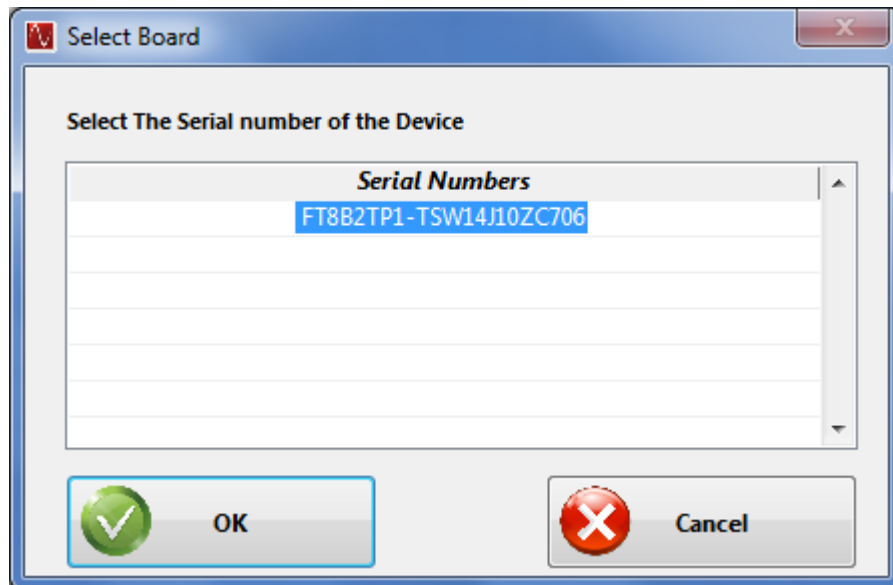

Figure 27. Serial Number Selection Window

In the GUI, select the *DAC* tab, then select DAC3XJ84_LMF_442 in the device button. After the firmware is loaded, enter 368.64M in the *Data Rate (SPS)* window, select 2's complement in the *DAC Output* window and generate a 10-MHz test tone using the IQ Multitone Generator located in the lower left of the GUI. Click the **Create Tones** button. The display will appear as shown in [Figure 28](#).

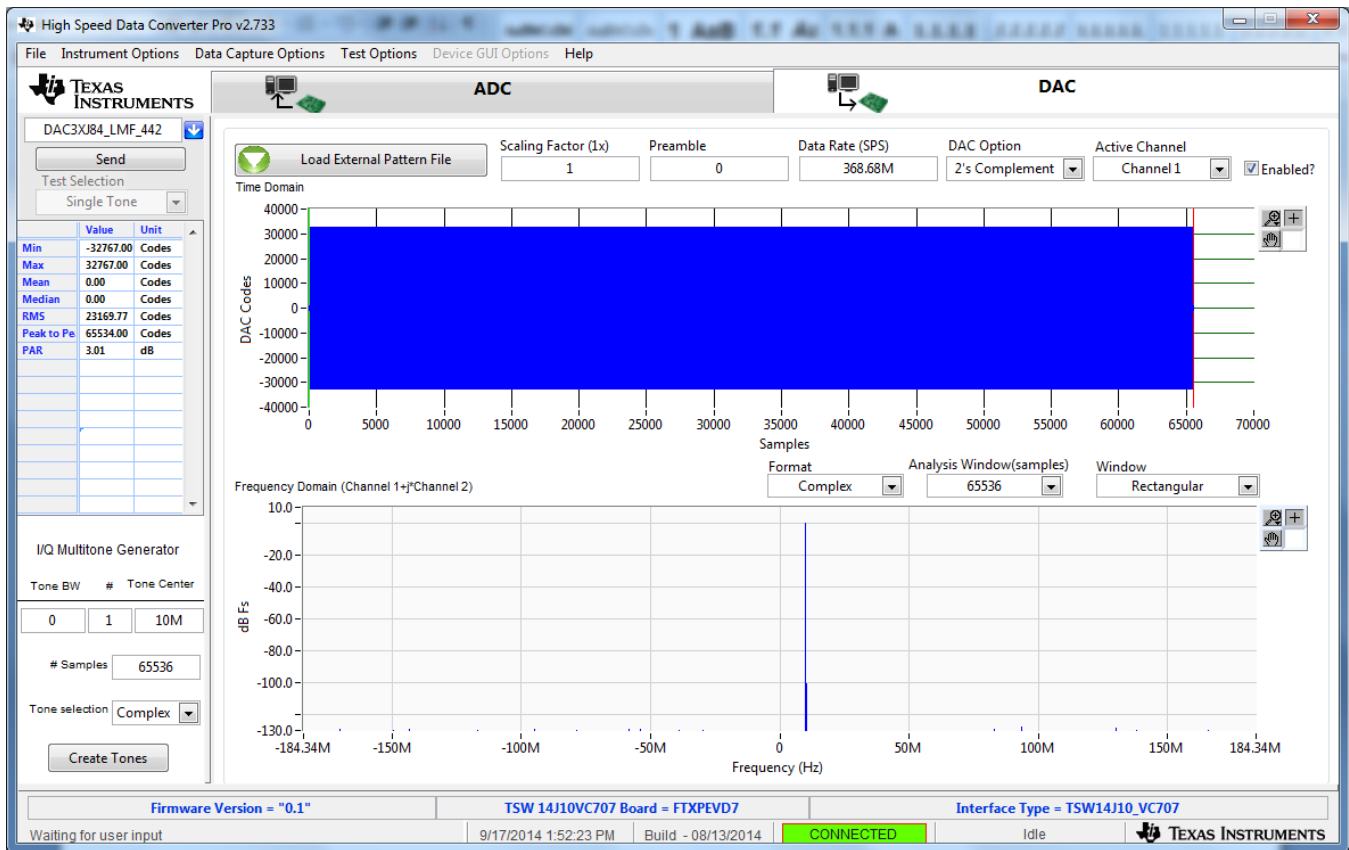

Figure 28. HSDC Pro GUI

Click the **Send** button. A new window opens showing the lane rate of the interface the required frequency of REFCLK, as shown in Figure 29.

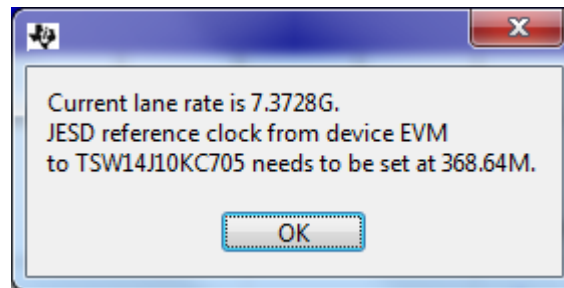

Figure 29. HSDC Pro GUI

Go back the DAC GUI *Quick Start* tab and click on "Reset DAC JESD Core".

Click on "Trigger LMK04828 SYSREF". There should now be a 10-MHz tone present at all four DAC EVM outputs.

Other EVM's that have tested with the ZC706 platform include the ADS42JB49/69, ADC32RF45, and DAC38J84.

Revision History

Changes from A Revision (October 2014) to B Revision

Page

-
- Updated the *DAC38J84EVM with Xilinx VC707 Development Board Setup Example* section. 16
 - Added the *ADC32RF45EVM With Xilinx VC707 Development Board Setup Example* section. 21
 - Added the *ADC12J4000EVM With Xilinx VC707 Development Board Setup Example* section. 25
 - Added the *ADC12J4000EVM With a Xilinx Zynq ZC706 Development Board Setup Example* section 30
 - Added the *DAC38J84EVM With a Xilinx Zynq ZC706 Development Board Setup Example* section. 32
-

IMPORTANT NOTICE

Texas Instruments Incorporated and its subsidiaries (TI) reserve the right to make corrections, enhancements, improvements and other changes to its semiconductor products and services per JESD46, latest issue, and to discontinue any product or service per JESD48, latest issue. Buyers should obtain the latest relevant information before placing orders and should verify that such information is current and complete. All semiconductor products (also referred to herein as "components") are sold subject to TI's terms and conditions of sale supplied at the time of order acknowledgment.

TI warrants performance of its components to the specifications applicable at the time of sale, in accordance with the warranty in TI's terms and conditions of sale of semiconductor products. Testing and other quality control techniques are used to the extent TI deems necessary to support this warranty. Except where mandated by applicable law, testing of all parameters of each component is not necessarily performed.

TI assumes no liability for applications assistance or the design of Buyers' products. Buyers are responsible for their products and applications using TI components. To minimize the risks associated with Buyers' products and applications, Buyers should provide adequate design and operating safeguards.

TI does not warrant or represent that any license, either express or implied, is granted under any patent right, copyright, mask work right, or other intellectual property right relating to any combination, machine, or process in which TI components or services are used. Information published by TI regarding third-party products or services does not constitute a license to use such products or services or a warranty or endorsement thereof. Use of such information may require a license from a third party under the patents or other intellectual property of the third party, or a license from TI under the patents or other intellectual property of TI.

Reproduction of significant portions of TI information in TI data books or data sheets is permissible only if reproduction is without alteration and is accompanied by all associated warranties, conditions, limitations, and notices. TI is not responsible or liable for such altered documentation. Information of third parties may be subject to additional restrictions.

Resale of TI components or services with statements different from or beyond the parameters stated by TI for that component or service voids all express and any implied warranties for the associated TI component or service and is an unfair and deceptive business practice. TI is not responsible or liable for any such statements.

Buyer acknowledges and agrees that it is solely responsible for compliance with all legal, regulatory and safety-related requirements concerning its products, and any use of TI components in its applications, notwithstanding any applications-related information or support that may be provided by TI. Buyer represents and agrees that it has all the necessary expertise to create and implement safeguards which anticipate dangerous consequences of failures, monitor failures and their consequences, lessen the likelihood of failures that might cause harm and take appropriate remedial actions. Buyer will fully indemnify TI and its representatives against any damages arising out of the use of any TI components in safety-critical applications.

In some cases, TI components may be promoted specifically to facilitate safety-related applications. With such components, TI's goal is to help enable customers to design and create their own end-product solutions that meet applicable functional safety standards and requirements. Nonetheless, such components are subject to these terms.

No TI components are authorized for use in FDA Class III (or similar life-critical medical equipment) unless authorized officers of the parties have executed a special agreement specifically governing such use.

Only those TI components which TI has specifically designated as military grade or "enhanced plastic" are designed and intended for use in military/aerospace applications or environments. Buyer acknowledges and agrees that any military or aerospace use of TI components which have **not** been so designated is solely at the Buyer's risk, and that Buyer is solely responsible for compliance with all legal and regulatory requirements in connection with such use.

TI has specifically designated certain components as meeting ISO/TS16949 requirements, mainly for automotive use. In any case of use of non-designated products, TI will not be responsible for any failure to meet ISO/TS16949.

Products

Audio	www.ti.com/audio
Amplifiers	amplifier.ti.com
Data Converters	dataconverter.ti.com
DLP® Products	www.dlp.com
DSP	dsp.ti.com
Clocks and Timers	www.ti.com/clocks
Interface	interface.ti.com
Logic	logic.ti.com
Power Mgmt	power.ti.com
Microcontrollers	microcontroller.ti.com
RFID	www.ti-rfid.com
OMAP Applications Processors	www.ti.com/omap
Wireless Connectivity	www.ti.com/wirelessconnectivity

Applications

Automotive and Transportation	www.ti.com/automotive
Communications and Telecom	www.ti.com/communications
Computers and Peripherals	www.ti.com/computers
Consumer Electronics	www.ti.com/consumer-apps
Energy and Lighting	www.ti.com/energy
Industrial	www.ti.com/industrial
Medical	www.ti.com/medical
Security	www.ti.com/security
Space, Avionics and Defense	www.ti.com/space-avionics-defense
Video and Imaging	www.ti.com/video

TI E2E Community

e2e.ti.com