

NO.	DESCRIPTION	DATE

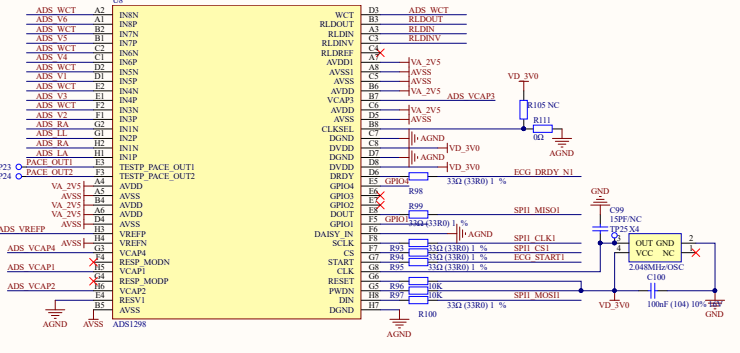
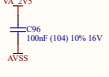
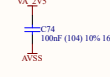
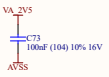
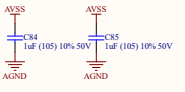
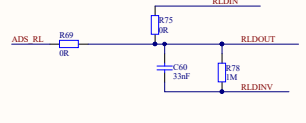
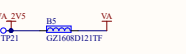
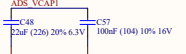
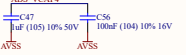
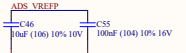
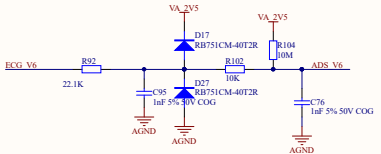
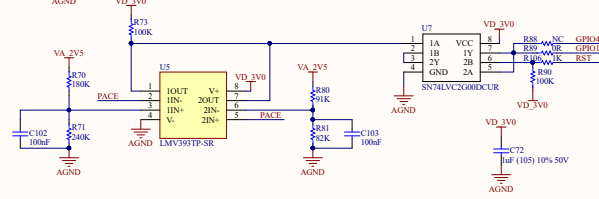
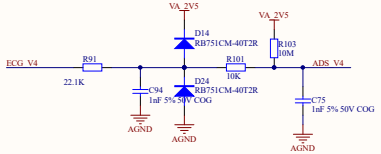
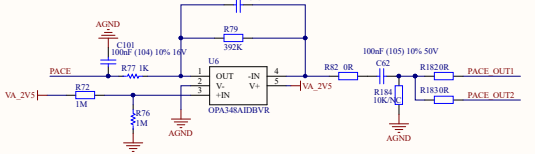
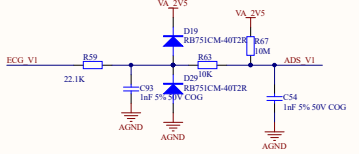
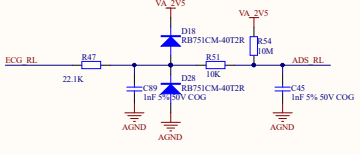
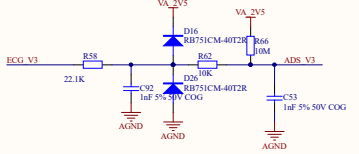
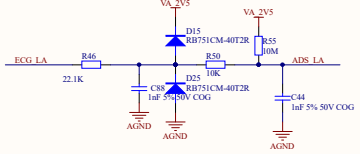
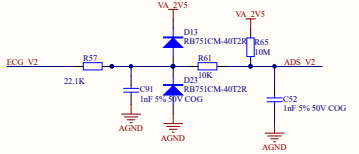
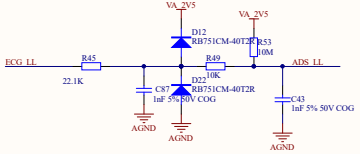
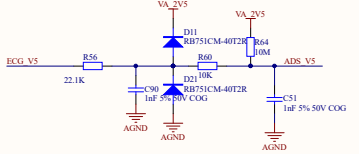
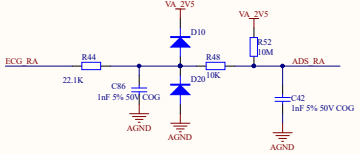

DRAWING NAME	MATERIAL
DocumentName	2 of 3
DESIGNED BY	DATE
CHECK BY	DATE
APPROVAL BY	DATE