

HEADERS TO CONNECT TO 4 LOAD CELLS

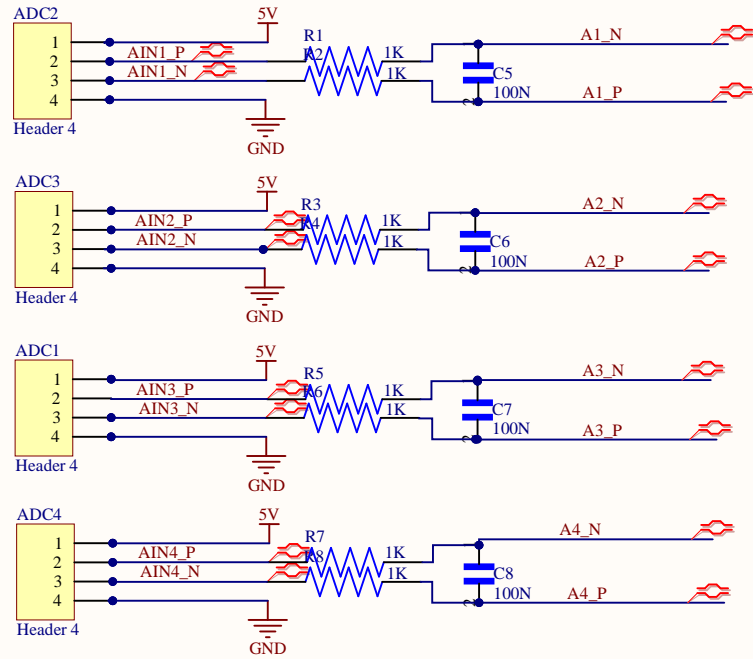

ADS1234 24-BIT ADC

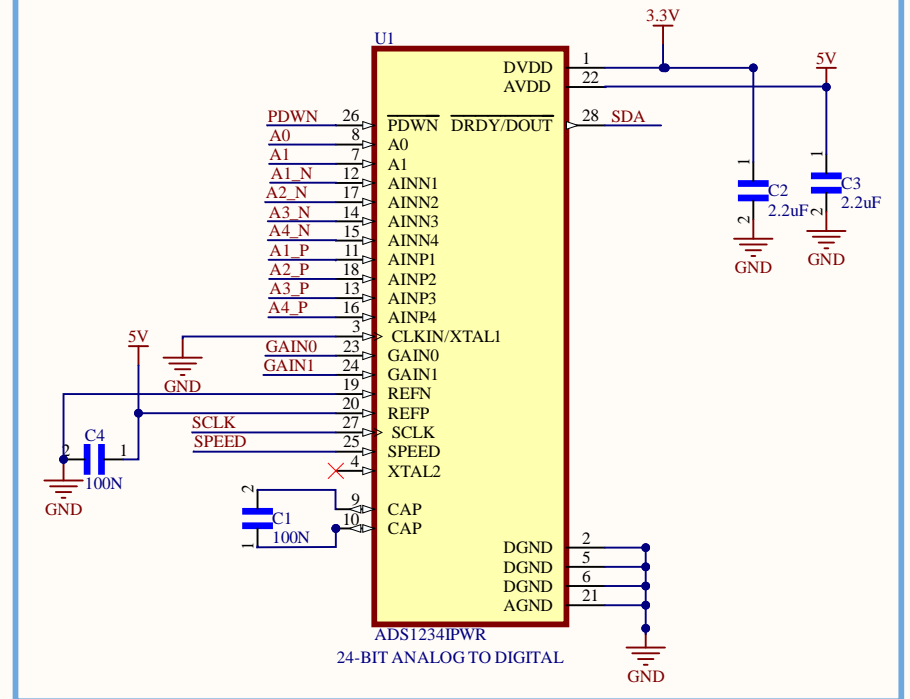

INPUT POWER

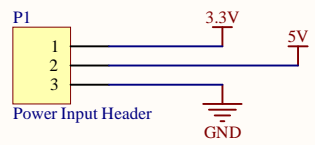

I2C AND CONTROL INPUT

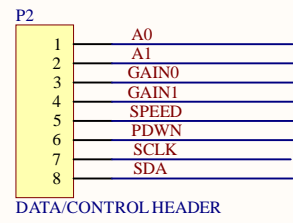

Title		
Size	Number	Revision
A4		
Date:	9-30-2021	Sheet of
File:	C:\Users\...\ADS1234.SchDoc	Drawn By:

