

TSW30SH84 Evaluation Module

The Texas Instruments TSW30SH84 evaluation module (EVM) provides a basic platform to evaluate the DAC34SH84 in a complete RF transmit signal chain. Along with the DAC34SH84, the EVM includes a LMK04808B clock jitter cleaner and generator source, which provides the clocks required for the DAC and the external pattern generator. The EVM also includes on-board TRF3705 I/Q modulators, which provide IF-to-RF upconversion for basic transmitter evaluation. This EVM is ideally suited for mating with the Texas Instruments TSW1400 pattern generation board for evaluating WCDMA, LTE, or other high-performance modulation schemes.

Contents

1	Introduction	2
	1.1 Overview	2
	1.2 EVM Block Diagram	3
2	Software Control	4
	2.1 Installation Instructions	4
	2.2 Software Operation	4
3	Basic Test Procedure with TSW1400	14
	3.1 TSW1400 Overview	14
	3.2 Test Block Diagram for TSW1400	14
	3.3 Test Setup Connection	15
	3.4 TSW30SH84 Example Setup Procedure	16
	3.5 TSW1400 Example Setup Procedure	17
4	Basic Test Procedure with TSW3100	20
	4.1 TSW3100 Overview	20
	4.2 Test Block Diagram for TSW3100	20
	4.3 Test Setup Connection	21
	4.4 TSW30SH84 Example Setup Procedure	21
	4.5 TSW3100 Example Setup Procedure	22
5	Optional Configuration	22
	5.1 Configuring the LMK04800 for Clock Distribution Mode	23
	5.2 Configuring the LMK04800 for Single PLL (PLL2 Only) Mode	23
	5.3 Configuring the LMK04800 for Dual PLL (PLL1 + PLL2) Mode.	23
6	Transmit Path Optional Configuration	23
	6.1 Shared LO Path	23
	6.2 Additional RF amp and attenuator path	23
7	References	25
	7.1 Related Products From Texas Instruments	25
	7.2 Related Tools From Texas Instruments	25

List of Figures

1	TSW30H84EVM Block Diagram	3
2	Input Tab Control Options – DAC348x.....	5
3	PLL Configuration.....	6
4	Digital Tab Control Options – DAC348x	7
5	Output Tab Control Options – DAC348x.....	9
6	LMK04800 Tab Control Options.....	10

7	LMK04800 Advanced Settings Control Panel	12
8	RF Attenuator Control.....	13
9	USB Port Reset.....	13
10	TSW1400 and TSW30SH84 Test Setup Block Diagram.....	14
11	EVM Platform Selection	16
12	Select DAC34SH84 in the High Speed Converter Pro GUI Program	17
13	Load DAC Firmware Prompt.....	17
14	Load File to Transfer into TSW1400	18
15	TSW30SH84 WCDMA Output (TRF3705 Low-Gain Mode)	19
16	TSW30SH84 WCDMA Output (TRF3705 High-Gain Mode).....	19
17	TSW3100 FPGA Clock 100-Ω LVDS Termination at Pins T31 and T32 of the FPGA	20
18	TSW3100 and TSW30SH84 Test Setup Block Diagram	21
19	TSW3100 GUI for LVDS DDR Format.....	22
20	LMK04800 Mode Selection	22
21	TSW30SH84 RF Amp / Attenuator Output (TRF3705 Low-Gain Mode)	24
22	TSW30SH84 RF Amp / Attenuator Output (TRF3705 High-Gain Mode)	24

1 Introduction

1.1 Overview

The TSW30SH84 evaluation module (EVM) is a circuit board that allows designers to evaluate the performance of the Texas Instruments DAC34SH84 digital-to-analog converters (DAC). The 16-bit, 1.5GSPS, DAC34SH84 has integrated 2x/4x/8x/16x interpolation filters, 32-bit NCO, on-chip PLL, and exceptional linearity at high IFs. The EVM provides a flexible environment to test the DAC34SH84 under a variety of clock, data input, and RF output conditions. For ease of use as a complete RF transmit solution, the TSW30SH84EVM includes the LMK04808B low-noise, clock generator/jitter cleaner for clocking the DAC34SH84. Besides providing a high-quality, low jitter DAC sampling clock to the DAC34SH84, the LMK04808B also provides FPGA clocks to the TSW1400EVM (or TSW3100EVM) as FPGA reference clocks.

The EVM also has two TRF3705 quadrature modulators, with output ranging from 300MHz to 4GHz, to up-convert the I/Q outputs from the DAC to RF. The DAC34SH84 has two pairs of I/Q outputs that are routed directly to two TRF3705 modulators, and this design forms two transmit paths. The default RF signal paths is the direct TRF3705 I/Q modulator output. To add flexibility to the RF evaluation, the modulator outputs can also connect to the optional RF amplifier and programmable attenuator path to meet additional test conditions and requirements.

The EVM can be used along with TSW1400 or TSW3100 with limited data rate support (up to 1.25GSPS LVDS Bus rate) to perform a wide varieties of test and measurement. The TSW1400 generates the test patterns that are fed to the DAC34SH84 through a 1.5GSPS LVDS Bus port. This board is also compatible with Altera® and Xilinx® FPGA development platforms for rapid evaluation and prototyping. The on-board HSMC connector input allows direct connection to the HSMC compatible Altera development platforms, and the externally attached FMC-DAC-Adapter board available from TI enables the connection of the EVM to the Xilinx development platforms with FMC headers.

Other DAC348x families can be evaluated on different EVM platforms. For details of the DAC348x family and the corresponding EVM part number, see [Table 1](#).

Table 1.

DAC Part No.	DAC3484	DAC3482	DAC34H84	DAC34SH84
EVM Part No.	TSW3084EVM	TSW3085EVM	TSW30H84EVM	TSW30SH84EVM
Output Channels	4	2	4	4
Maximum DAC Rate	1.25 GSPS	1.25 GSPS	1.25 GSPS	1.5 GSPS
Digital Interface	16-Bit LVDS Interface	16-Bit LVDS Interface	32-Bit LVDS Interface	32-Bit LVDS Interface
Maximum Data Rate per Channel	312.5 MSPS	625 MSPS	625 MSPS	750 MSPS
Maximum LVDS Bus Toggle Rate	1.25 GSPS	1.25 GSPS	1.25 GSPS	1.5 GSPS
Pattern Generator Support	TSW1400/TSW3100	TSW1400/TSW3100	TSW1400/TSW3100	TSW1400/TSW3100 with limited data rate support

See the DAC348x EVM web folders at:

- <http://www.ti.com/tool/dac3482evm>
- <http://www.ti.com/tool/dac3484evm>
- <http://www.ti.com/tool/dac34h84evm>
- <http://www.ti.com/tool/dac34sh84evm>

For evaluation of the DAC348x family with transformer coupled IF output, see the DAC348xEVM user's guide (SLAU432).

1.2 EVM Block Diagram

Figure 1 shows the TSW308xEVM block diagram.

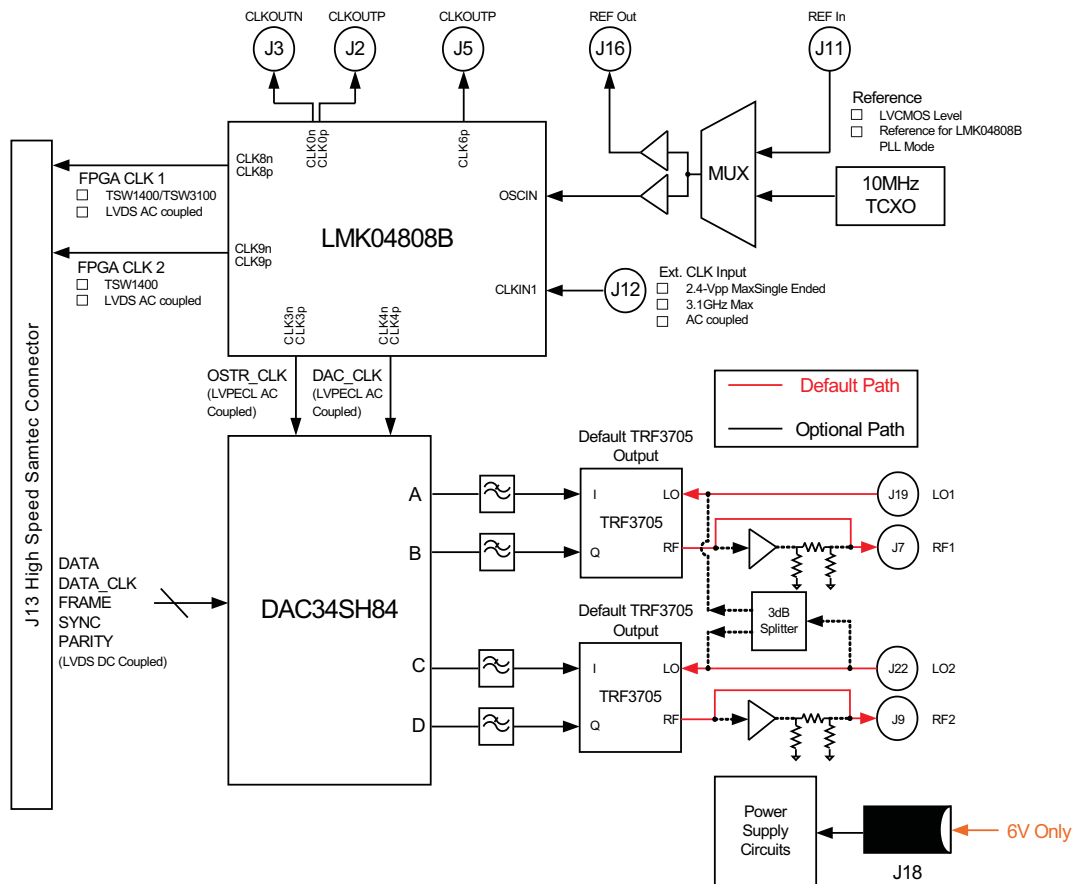

Figure 1. TSW30H84EVM Block Diagram

2 Software Control

2.1 Installation Instructions

Perform the following steps to install the software.

1. Open the folder named TSW308x_Installer_vxpx (xpx represents the latest version).
2. Run Setup.exe.
3. Follow the onscreen instructions.
4. Once installed, launch the program by clicking on the TSW308x program in Start>TSW308x. The installation directory is located at C:\Program Files\Texas Instruments\TSW308x.
5. When plugging in the USB cable for the first time, you are prompted to install the USB drivers.
 - (a) When a pop-up screen opens, select *Continue Downloading*.
 - (b) Follow the onscreen instructions to install the USB drivers.
 - (c) If needed, the drivers can be accessed directly in the install directory.

2.2 Software Operation

The software allows programming control of the DAC, the LMK, and the attenuator devices. The front panel provides a tab for full programming of each device. The GUI tabs provide a more convenient and simplified interface to the most used registers of each device.

Each device has its own custom control interface. At the top level of the GUI are five control tabs. The first four are used to configure the DAC348x and the last for the LMK04800. The attenuator control window on the right side of the GUI is used to program the attenuator.

2.2.1 Input Tab Control Options

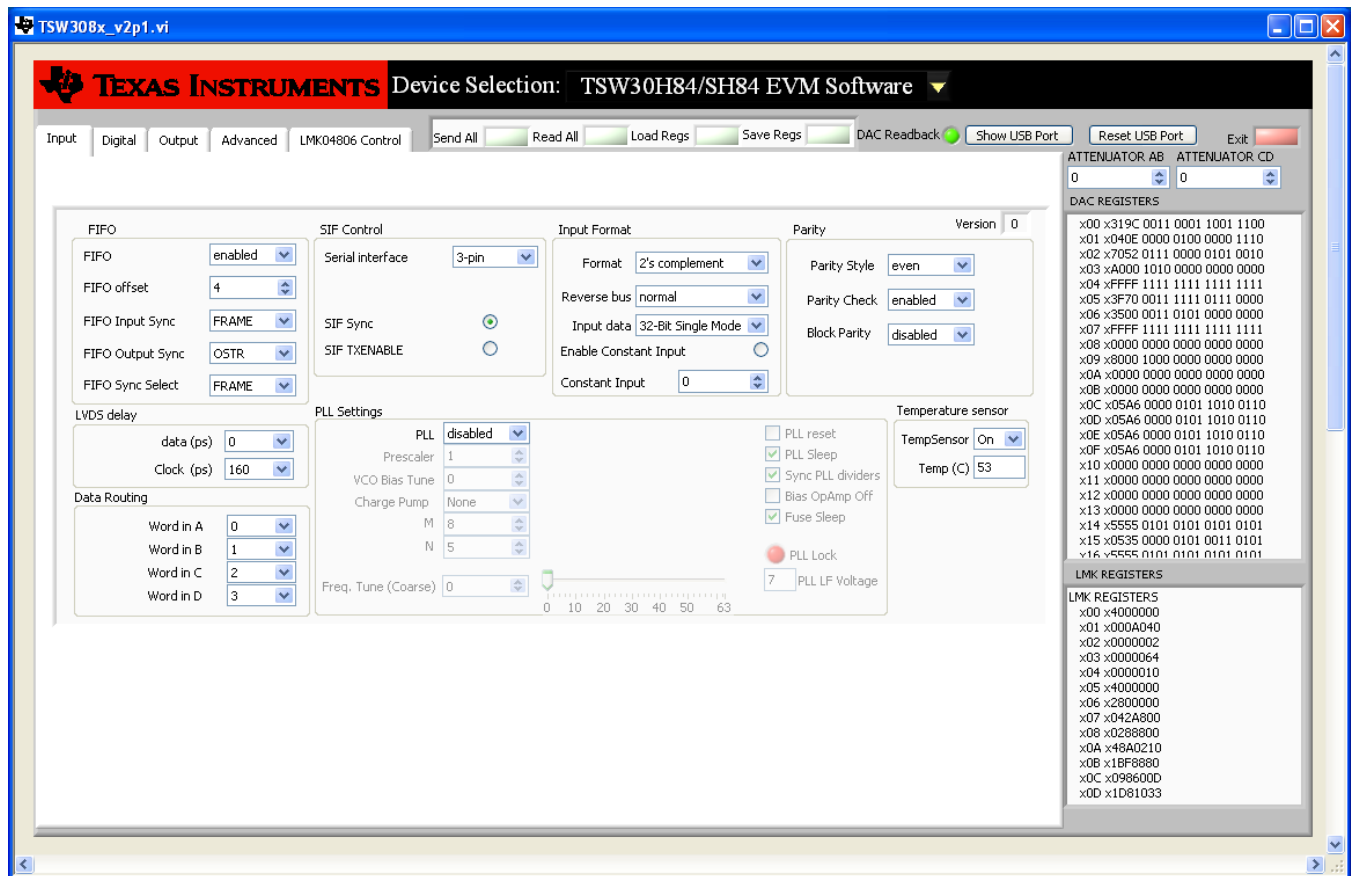

Figure 2. Input Tab Control Options – DAC348x

- FIFO: allows the configuration of the FIFO and FIFO synchronization (sync) sources.
- LVDS delay: provides internal delay of either the LVDS DATA or LVDS DATACLK to help meet the input setup/hold time.
- Data Routing: provides flexible routing of the A, B, C, and D sample input data to the appropriate digital path. **Note:** the DAC3482 does not support this mode.
- SIF Control: provides control of the Serial Interface (3-wire or 4-wire) and Serial Interface Sync (*SIF Sync*).
- Input Format: provides control of the input data format (i.e., 2's complement or offset binary).
- Parity: provides configuration of the parity input.
- PLL Settings: provides configuration of the on-chip PLL circuitry.
- Temperature Sensor: provides temperature monitoring of DAC348x die temperature.

2.2.1.1 FIFO Settings

The DAC348x has 8-samples deep FIFO to relax the timing requirement of a typical transmitter system. The FIFO has an input pointer and an output pointer, and both pointers can accept various input sources as reset triggers of input and output pointer position. One important application for input and output pointer control is the ability to synchronize multiple DACs in the system. For additional information, see the relevant DAC348x data sheet.

- FIFO Offset: The default position of FIFO output pointer after reset by the synchronization source. This setting can be used to change the latency of the DAC348x.
- Data Formatter Sync (DAC3482 and DAC3484): Synchronization source for FIFO data formatter. Select between LVDS FRAME or LVDS SYNC signals.

- FIFO Sync Select (DAC34H84 and DAC34SH84): Select the internal digital routing of LVDS ISTR or LVDS SYNC to the FIFO ISTR path
- FIFO Input Sync: Synchronization source for FIFO input pointer. Select among the LVDS FRAME (ISTR), LVDS SYNC, and/or SPI register SIF-SYNC to reset the FIFO input pointer position.
- FIFO Output Sync: Synchronization source for FIFO output pointer. Select among the LVDS FRAME (ISTR), LVDS SYNC, SPI register SIF-SYNC, and/or OSTR signal to reset the FIFO output pointer position.
 - For single device application without the need for precise latency control, Single Sync Source Mode may be used. The FIFO output pointer position can be reset with LVDS FRAME (ISTR), LVDS SYNC, and/or SPI register SIF-SYNC. See the Single Sync Source Mode in the relevant DAC348x data sheet for details.
 - For multiple device synchronization, select the OSTR signal as the FIFO output synchronization source. If the DAC is configured to accept external DAC Clock input, then the OSTR signal is the external LVPECL signal to the OSTRP/N pins. If the DAC is configured to accept the internal on-chip PLL clock, then the OSTR signal is the internally generated PFD frequency. See the Dual Sync Sources Mode in the relevant DAC348x data sheet for details.

2.2.1.2 LVDS Delay Settings

Depending on the signal source implementation (i.e. TSW1400, TSW3100, or FPGA system), the following options can be implemented to meet the minimum setup and hold time of DAC348x data latching:

- Set the on-chip LVDS DATACLK delay: The DAC348x includes on-chip LVDS DATA or DATACLK delay. The delay ranges from 0ps to 280ps with an approximate 40ps step. This LVDS DATACLK delay does not account for additional PCB trace-to-trace delay variation, only the internal DATACLK delay.
 - The TSW1400 pattern generator sends out LVDS DATA and DATACLK as center-aligned signal. Additional DATACLK delay is not needed.
 - The TSW3100 pattern generator sends out LVDS DATA and DATACLK as edge-aligned signal. Typical setting of 160ps or more will help meet the timing requirement for most of the TSW3100 + DAC348x EVM setup.
- Modify the external LVDS DATACLK PCB trace delay: Additional trace length can be added to the DATACLK P&N PCB trace length. At the top side, set SJP9, SJP10, SJP11, and SJP12 to the 2-3 position for approximately 280ps of trace delay.

2.2.1.3 PLL Settings

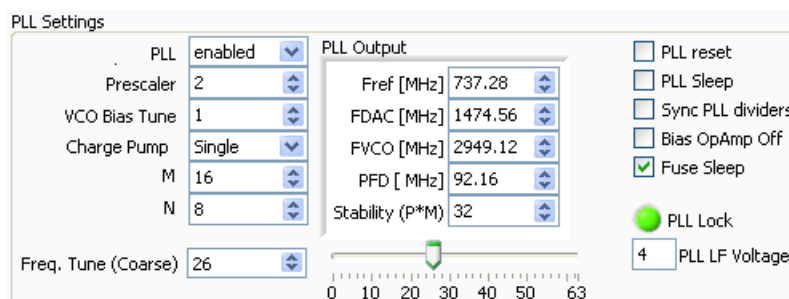

Figure 3. PLL Configuration

Perform the following steps to configure the PLL.

1. Enable PLL.
2. Uncheck *PLL reset* and *PLL sleep*.
3. Set *M* and *N* ratio such that $F_{DAC} = (M)/(N) \times F_{ref}$.
4. For the DAC3482, DAC3484, and DAC34H84, set the *prescaler* such that the $F_{DAC} \times \text{prescaler}$ is within 3.3 GHz and 4 GHz.
5. For the DAC34SH84, set the *prescaler* such that the $F_{DAC} \times \text{prescaler}$ is within 2.7 GHz and 3.3 GHz.
6. Set *VCO Bias Tune* to 1.
7. *Charge Pump* setting
 - (a) If stability ($P \times M$) is less than 120, then set to *Single*.
 - (b) If stability ($P \times M$) is greater than 120, then set to *Double* or install external loop filter.
8. Adjust the *Freq. Tune (Coarse)* accordingly. For additional information, see the relevant DAC348x data sheet.

2.2.2 Digital Tab Control Options

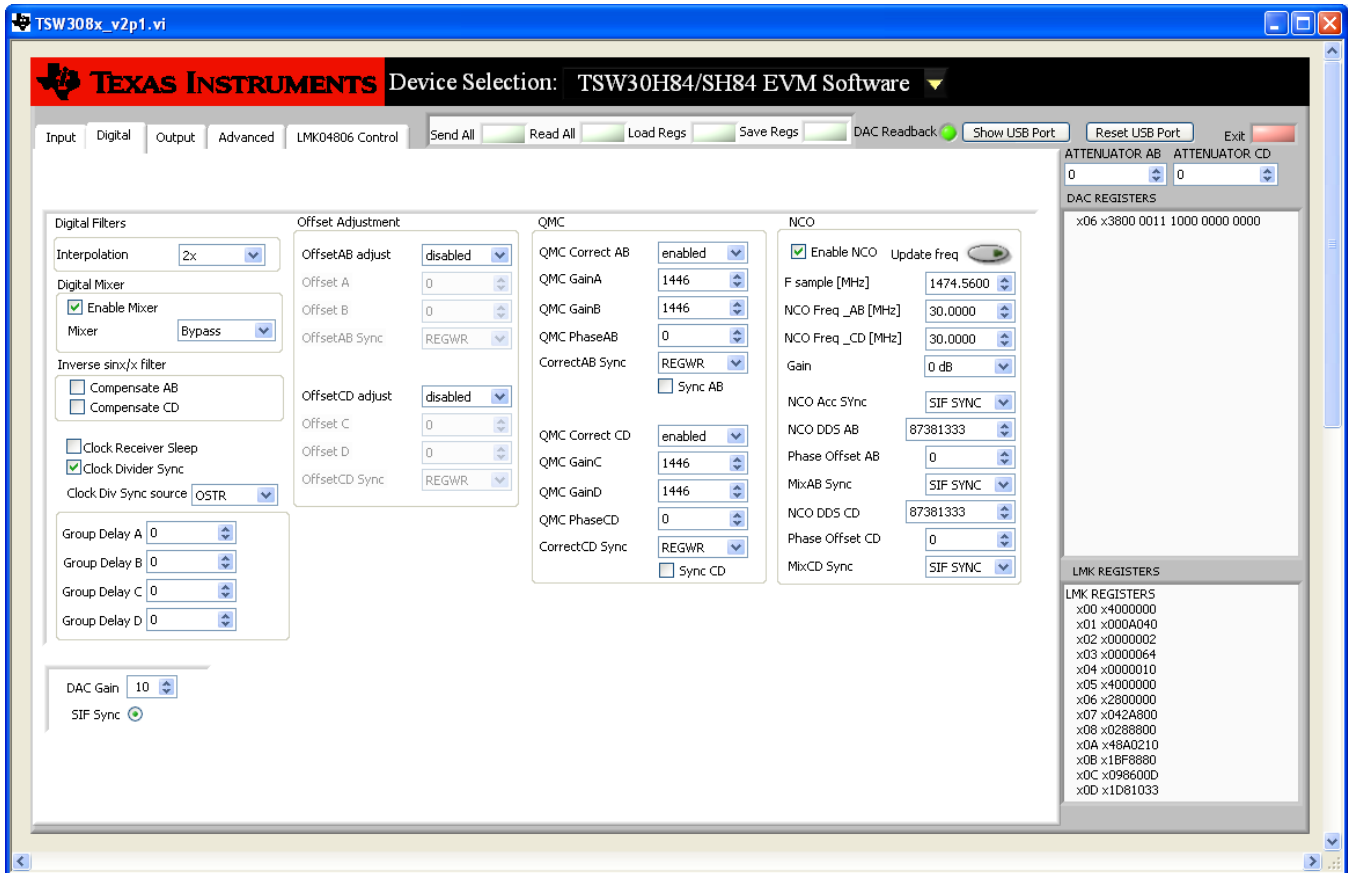

Figure 4. Digital Tab Control Options – DAC348x

- Interpolation: allows control of the data rate versus DAC sampling rate ratio (i.e., data rate \times interpolation = DAC sampling rate).
- Digital Mixer: allows control of the coarse mixer function.
Note: If fine mixer (NCO) is used, the Enable Mixer button must be checked, and the coarse mixer must be bypassed. See the following NCO bullet for detail.

- Inverse $\sin x/x$ filter: allows compensation of the $\sin x/x$ attenuation of the DAC output.
Note: If inverse $\sin x/x$ filter is used, the input data digital full-scale must be backed off accordingly to avoid digital saturation.
- Clock Receiver Sleep: allows the DAC clock receiver to be in sleep mode. The DAC has minimum power consumption in this mode.
- Clock Divider Sync: allows the synchronization of the internal divided-down clocks using either Frame, Sync, or OSTR signal. Enables the divider sync as part of the initialization procedure or resynchronization procedure.
- Group Delay: allows adjustment of group delay for each I/Q channel. This is useful for wideband sideband suppression. **Note:** This feature is not available for the DAC34SH84.
- Offset Adjustment: allows adjustment of dc offset to minimize the LO feedthrough of the modulator output. This section requires synchronization for proper operation. The synchronization options follow:
 - **REGWR: auto-sync from SIF register write. If this option is chosen, the GUI automatically synchronizes the offset adjustment with each value update by writing to 0x08 (Offset A) or 0x0A (Offset C) registers last.**
 - *OSTR*: sync from the external LVPECL OSTR signal. Clock divider sync must be enabled with OSTR set as sync source.
 - *SYNC*: sync from the external LVDS SYNC signal.
 - **SIF SYNC: sync from SIF Sync. Uncheck and check the SIF Sync button for sync event.**
- QMC Adjustment: allows adjustment of the gain and phase of the I/Q channel to minimize sideband power of the modulator output.
 - **REGWR: auto-sync from SIF register write. If this option is chosen, the GUI automatically synchronizes the offset adjustment with each value update by writing to 0x10 (QMC PhaseAB) or 0x11 (QMC PhaseCD) registers last.**
 - *OSTR*: sync from the external LVPECL OSTR signal. Clock Divider Sync must be enabled with OSTR set as sync source.
 - *SYNC*: sync from the external LVDS SYNC signal.
 - **SIF SYNC: sync from SIF Sync. Uncheck and check the SIF Sync button for sync event.**
- NCO: allows fine mixing of the I/Q signal. The procedure to adjust the NCO mixing frequency follows.
 1. Enter the DAC sampling frequency in Fsample.
 2. Enter the desired mixing frequency in both NCO freq_AB and NCO freq_CD.
 3. Press Update freq.
 4. Synchronize the NCO block from the following options.
 - **REGWR: auto-sync from SIF register write. Writing to either Phase OffsetAB or Phase OffsetCD can create a sync event.**
 - *OSTR*: sync from the external LVPECL OSTR signal. Clock Divider Sync must be enabled with OSTR set as sync source. See the data sheet for OSTR period requirement.
 - *SYNC*: sync from the external SYNC signal.
 - **SIF SYNC: sync from SIF Sync. Uncheck and check the SIF Sync button for sync event.**

2.2.3 Output Tab Control Options

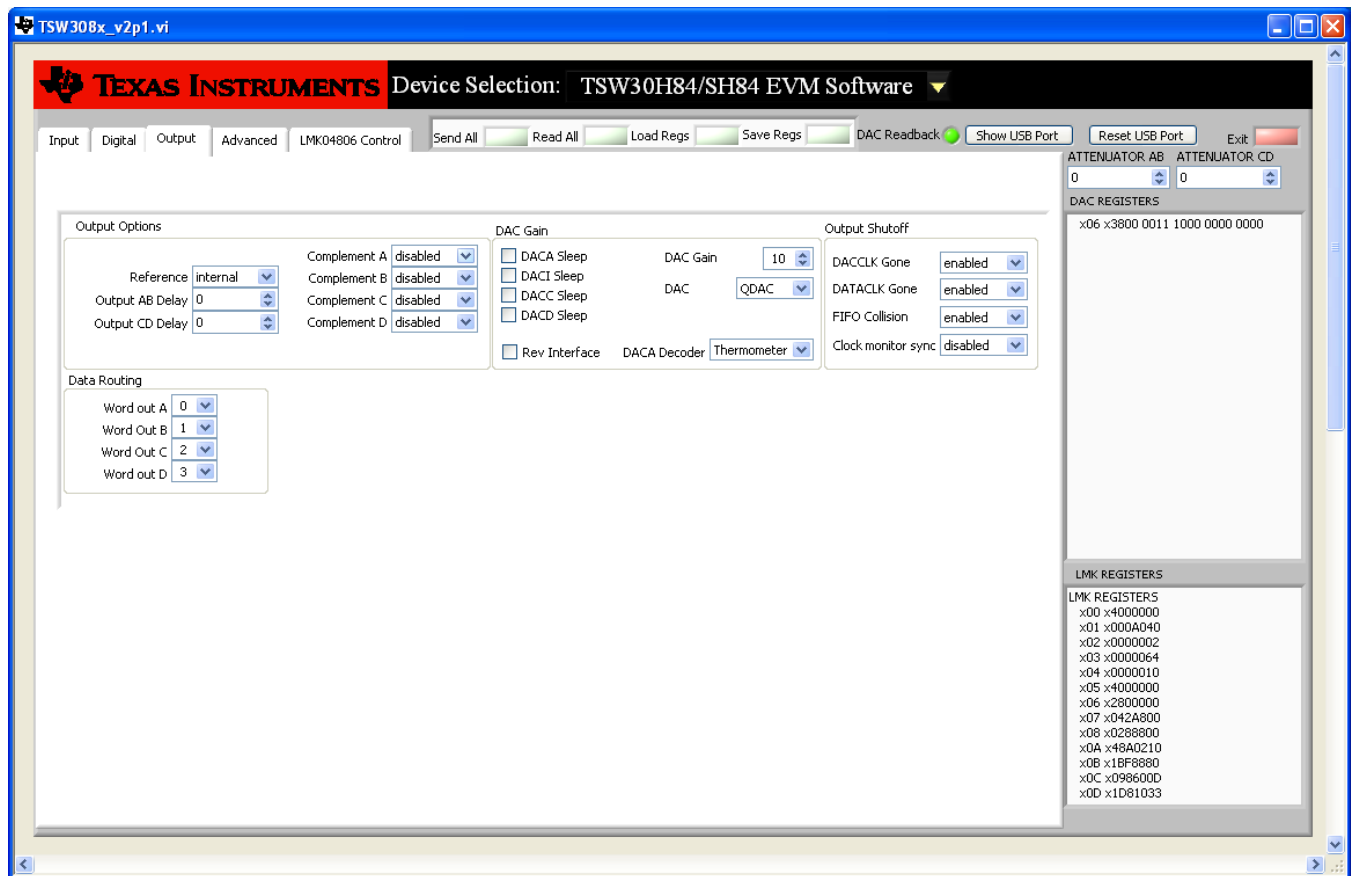

Figure 5. Output Tab Control Options – DAC348x

- Output Options: allows the configuration of reference, output polarity, and output delay
- Data Routing: provides flexible routing of the A, B, C, and D digital path to the desired output channels. **Note:** The DAC3482 does not support this mode.
- DAC Gain: configures the full-scale DAC current and DAC3484/DAC3482 mode. With Rbiasj resistor set at 1.28 kΩ:
 - DAC Gain = 15 for 30-mA, full-scale current.
 - DAC Gain = 10 for 20-mA, full-scale current (default).
- Output Shutoff On: allows outputs to shut off when DACCLK GONE, DATACLK GONE, or FIFO COLLISION alarm event occurs.

2.2.4 LMK04800

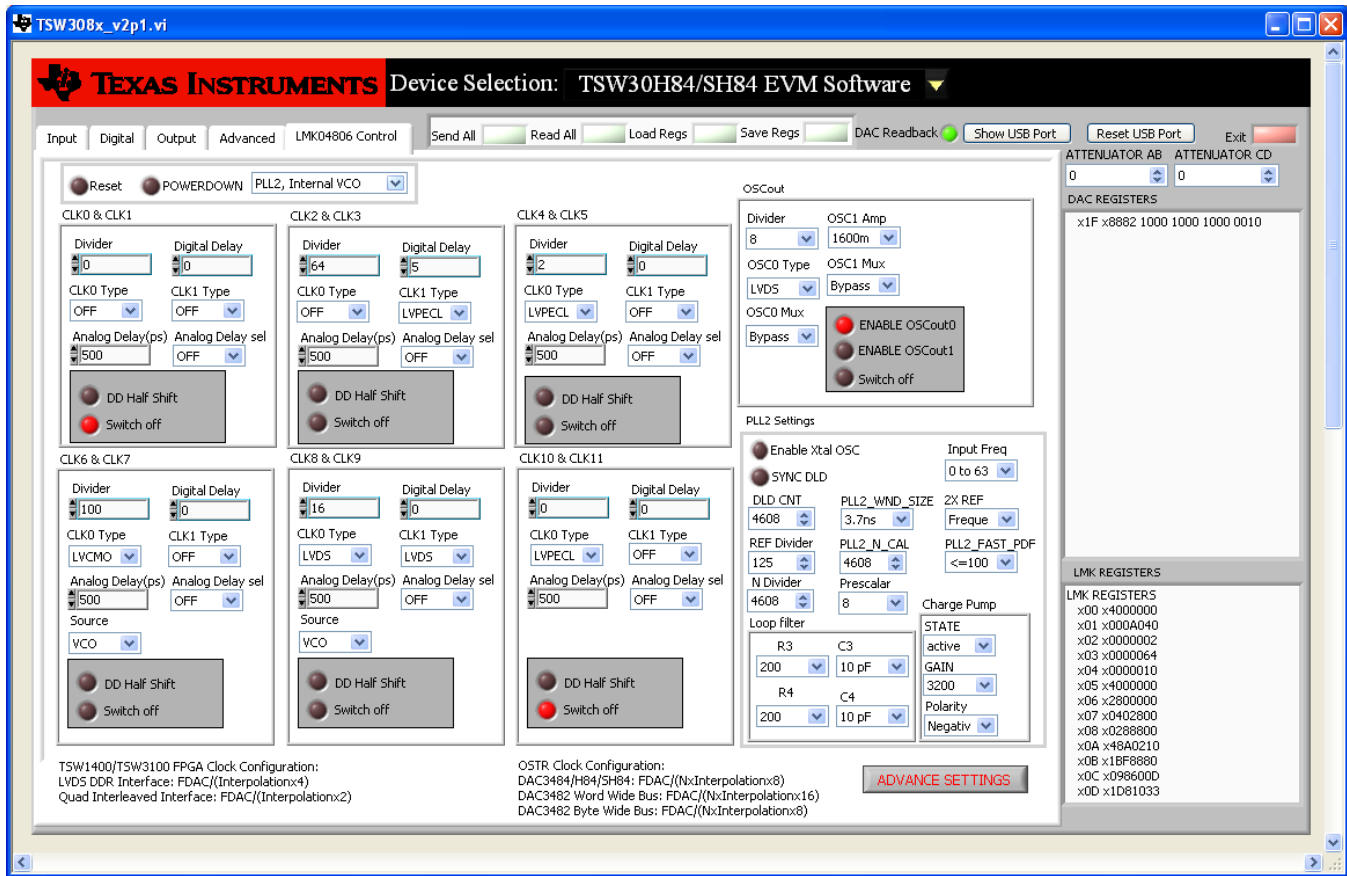

Figure 6. LMK04800 Tab Control Options

Clock control is determined by register values in the LMK04800 Control tab. See the LMK04800 family data sheet for detailed explanations of the register configurations.

The LMK04800 has 12 available output clocks. The following LMK04800 outputs are used by the TSW30SH84EVM:

- CLK4: DAC348x DAC sampling clock. This clock type is AC coupled LVPECL. If the DAC348x is configured for internal PLL mode, this becomes the reference clock input for the PLL block.
- CLK8: TSW1400/TSW3100 FPGA input clock (#1). This clock type is AC coupled LVDS. The clock rate must be set to $F_{DAC}/interpolation/4$.
- CLK9: TSW1400 FPGA input clock (#2). This clock type is AC coupled LVDS. It is required to evaluate the TSW30H84 and TSW30SH84 with the TSW1400. The clock rate must be set to $F_{DAC}/interpolation/4$.
- CLK3: DAC348x FIFO OSTR Clock. This clock type is AC coupled LVPECL.
 - The OSTR signal can be a slower periodic signal or a pulse depending on the application.
 - The OSTR clock rate must be at most $F_{DAC}/interpolation/8$. See the DAC348x data sheet for more detail.
 - The FIFO OSTR clock must be disabled when the DAC348x is using the on-chip PLL for DACCLK generation.
- CLK6: Spare output clock at SMA J5.
- CLK0: Spare output clock at SMA J2 and J3.

The clock settings are divided into subcontrol sections. These sections allow the user to set the divide ratio, digital delay, type, analog delay, and ON/OFF control. Note that clock pairs share several settings.

The OSCout control section allows the user to configure the settings for the OSCIN input. The TSW30SH84EVM uses this input as the reference input for Single Loop mode of operation (default configuration). This mode uses PLL2 of the device. This reference can be provided by either the onboard 10MHz oscillator (default) or from an external source brought in through SMA J11. For details, see [Section 5](#).

The PLL2 Settings control section allows the user to configure the settings for the internal PLL2. The LMK04800 family contains four devices that cover internal VCO frequencies from 1840MHz to 3072MHz. The VCO range of the LMK04808B is 2750MHz to 3072MHz. The TSW30SH84EVM default test case uses settings to set the internal VCO to 2949.12MHz and is locked to the 10MHz input source on OSCIN.

The default Single Loop PLL settings provided by the example file provide a 1474.56MHz clock on CLK4 for the DAC34SH84, the divided-down FPGA clock at CLK8 and CLK9 for the TSW1400 pattern generator FPGA input clock, and the divided-down OSTR clock for DAC348SH84's OSTR input. The CLK6 (J5) is configured as a divided-by-100 CMOS clock. This can be used as part of EVM functionality verification. For details, see [Section 4.5](#).

After the default settings are loaded, the output clocks are synchronized with the onboard 10MHz reference oscillator as indicated by *LMK LOCK LED(D7)* being illuminated.

Clicking on the Advance Settings tab at the bottom of the GUI opens a new window allowing the user to set other internal registers for different modes of operation as shown in [Figure 7](#).

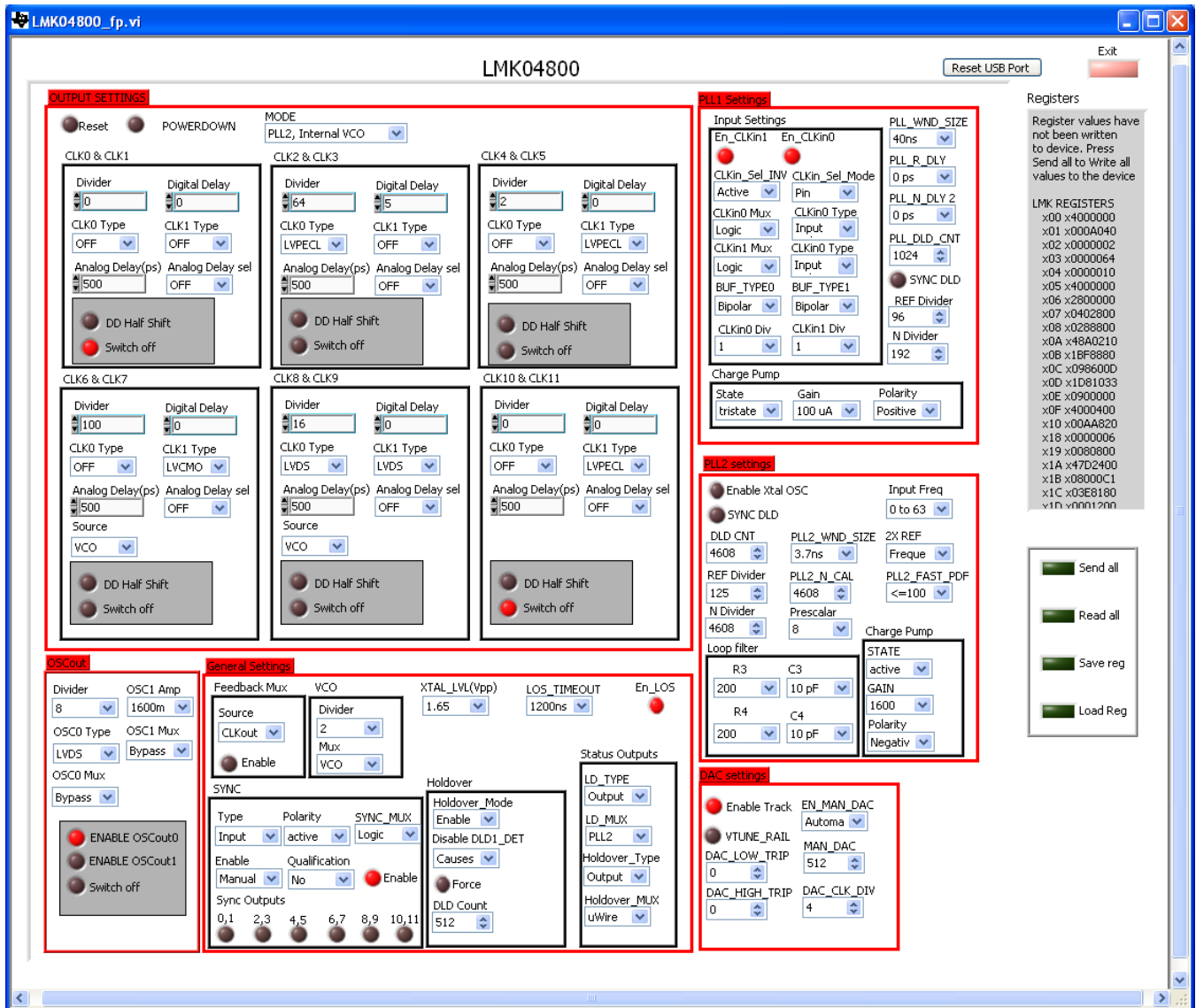

Figure 7. LMK04800 Advanced Settings Control Panel

2.2.5 Register Control

- Send All: sends the register configuration to all devices.
- Read All: reads register configuration from DAC348x and LMK04800 devices.
- Load Regs: loads a register file for all devices. Example configuration files for the common frequency plan are located in the install directory: C:\Program Files\Texas Instruments\TSW308x\TSW308xEVM_Configuration_Files
 - Select *Load Regs* button.
 - Double-click on the *TSW308xEVM_Configuration_Files* folder and respective sub-folders for the EVM.
 - Double-click on the desired register file.
 - Click on *Send All* to ensure all the values are loaded properly.
- Save Regs: saves the register configuration for all devices.

2.2.6 Attenuator Control

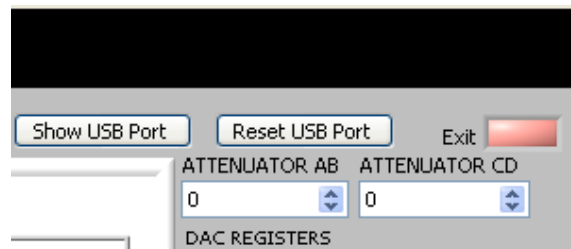

Figure 8. RF Attenuator Control

Each of the RF path on the TSW30SH84EVM contains a 50-Ω, RF digitally controlled attenuator that operates from DC to 4 GHz. This highly versatile digital step attenuator (DSA) covers a 0-dB to 31.75-dB attenuation range in 0.25-dB steps. It maintains high attenuation accuracy over frequency and temperature and exhibits very low insertion loss (1.9 dB, typical) and low-power consumption. The user can enter a value from 0 (minimum attenuation) to 31.75 (maximum attenuation) in 0.25 increments inside the Attenuator window (Figure 8) or by clicking on the drop-up/-down arrows.

2.2.7 Miscellaneous Settings

- Reset USB: toggle this button if the USB port is not responding. This generates a new USB handle address.
 - Note: It is recommended that the board be reset after every power cycle, and the reset USB button on the GUI be clicked.

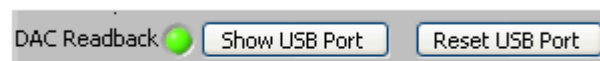

Figure 9. USB Port Reset

- Exit: stops the program

3 Basic Test Procedure with TSW1400

This section outlines the basic test procedure for testing the EVM with the TSW1400.

3.1 TSW1400 Overview

The TSW1400 is a high speed data capture and pattern generator board. When functioning as a pattern generator, it has a maximum LVDS bus rate of 1.5 GSPS, and this allows evaluation of the DAC34SH84 with maximum 750 MSPS of input data rate per channel.

See the TSW1400 user's guide ([SLWU079](#)) for more detailed explanation of the TSW1400 setup and operation. This document assumes that the High Speed Data Converter Pro software ([SLWC107](#)) is installed and functioning properly.

3.2 Test Block Diagram for TSW1400

The test set-up for general testing of the TSW30SH84EVM with the TSW1400 pattern generator card is shown in [Figure 10](#).

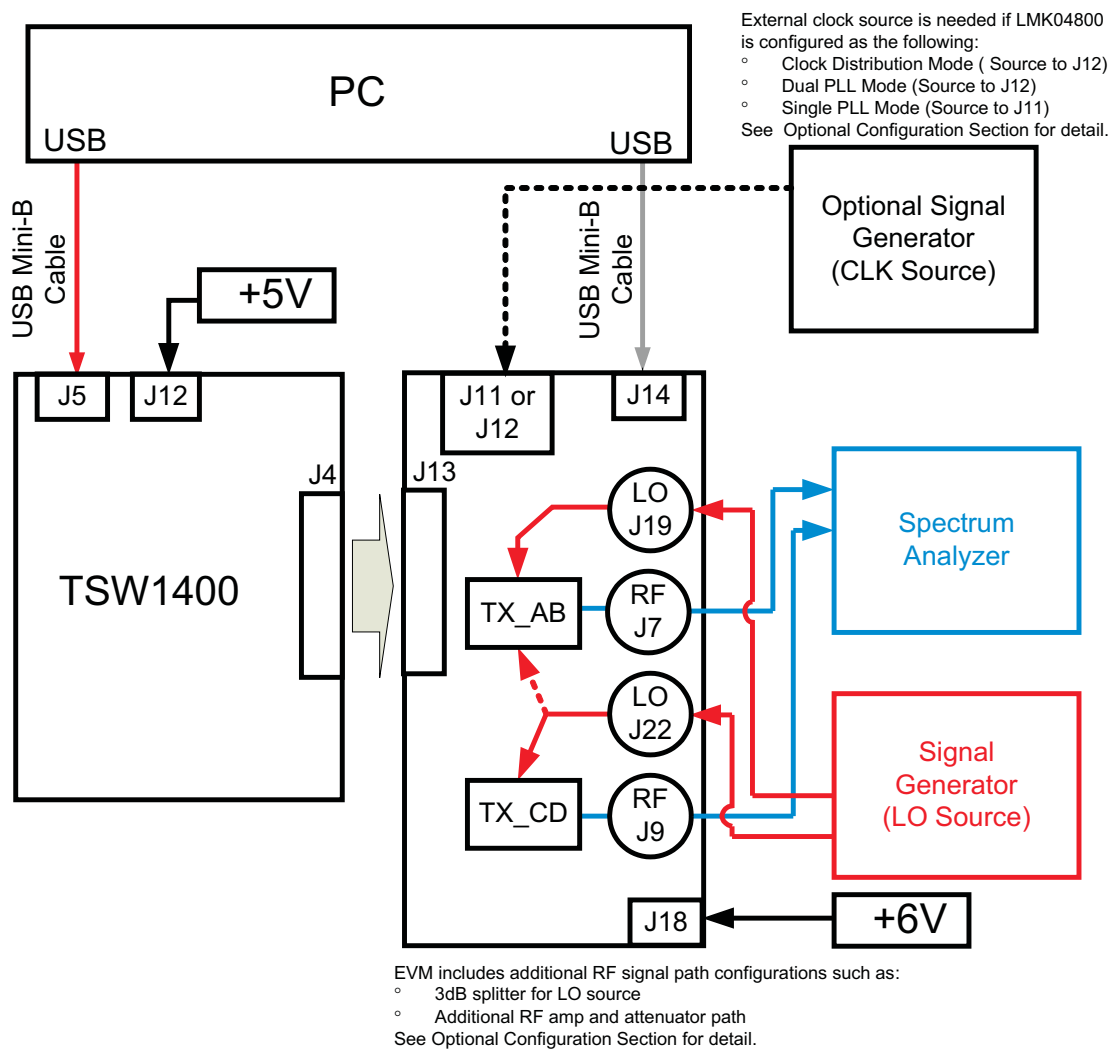

Figure 10. TSW1400 and TSW30SH84 Test Setup Block Diagram

3.3 Test Setup Connection

TSW1400 Pattern Generator.

1. Connect 5 V power supply to J12, *5V_IN* jack of the TSW1400 EVM.
2. Connect PC's USB port to J5 USB port of the TSW1400 EVM. The cable should be a standard A to mini-B connector cable.

TSW30SH84EVM

1. Connect J13 connector of TSW30SH84 EVM to J4 connector of TSW1400 EVM.
2. Connect 6V to the J18, *Power In* jack of the TSW30SH84 EVM.
3. Connect PC's USB port to J14 USB port of the TSW30SH84 EVM. The cable should be a standard A to mini-B connector cable.
4. Provide 10 dBm maximum, 300 MHz to 4 GHz LO source to connectors J19 and/or J22. The J19 or the J22 connector routes the LO source to the respective TRF3705 modulator TX path. Optionally, the EVM can be configured to share the LO source between the two TX paths through an on-board 3 dB splitter. The source should be connected to J22 in this case. See the *TX Path Optional Configuration* section for details.
5. Connect the RF output port of J7 and/or J9 to the spectrum analyzer.
6. If an external reference is to be used with LMK04808B in single PLL mode, provide a 3.3 Vpp maximum, 140 MHz maximum clock to J11. Change SJP5 solder jumper to position 2-3 to route the external reference source to the LMK04808B OSCIN input.
7. If the LMK04808B is configured in clock distribution mode, provide a 2.4 Vpp maximum, 3.1 GHz maximum clock to J12. The external clock source will route to the LMK04808B CLKIN1 input.

Table 2. TSW30SH84EVM Jumpers: (make sure the following jumpers are at their default setting)

Reference Designator	Setting	Function
JP2	1-2	DAC34SH84 TXENABLE
JP3	2-3	DAC34SH84 SLEEP
JP4	1-2	10MHz TCXO Enable
JP12, JP13	2-3	TRF3705 Power Down
JP14, JP15	2-3	TRF3705 Gain Control
SJP2	2-3	CPLD EEPROM W/P
SJP3	1-2	USB Bus Power
SJP4	1-2	CPLD Clock Select
SJP5	1-2	Internal/External Reference Select for LMK04808B OSCIN
SJP9, SJP10, SJP11, SJP12	1-2	DAC348x DATACLK delay. Default is zero trace delay.

3.4 TSW30SH84 Example Setup Procedure

1. Turn on power to both boards, and press the reset button SW1 on the TSW30SH84EVM.
2. Start the TSW308x EVM GUI program. When the program starts, press the *RESET USB Port* button in the GUI, and verify USB communication.
3. Select the appropriate EVM platform on the software menu.

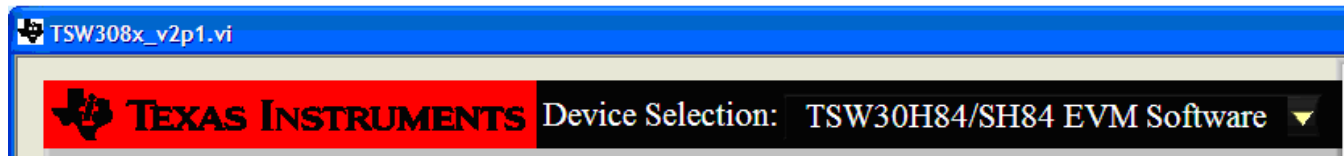

Figure 11. EVM Platform Selection

4. Click on *LOAD REGS*, browse to the installation folder, and load example files. The example files are located at *C:\Program Files\Texas Instruments\TSW308x\TSW308xEVM_Configuration_Files\TSW30SH84_32bitLVDS_4Channel*. To configure the LMK04808B in single PLL mode, select the file in the LMK04808 PLL Mode 10MHz reference folder. To configure the LMK04808B in clock distribution mode, select the file in the *LMK04808 Clock Distribution Mode* folder.
For the TSW30SH84, the files contain settings for 2x interpolation with the DAC34SH84 running at 1474.56 MSPS. The data rate for each DAC is at 737.28 MSPS. The NCO is enabled at 30 MHz.
5. Click on *Send All* to write all of the values to the devices. If the LMK04808B is programmed properly in single PLL mode, the *LMK LOCK* LED (D7) near the device will be illuminated. The updated register configuration for the LMK04808B now appears as shown in [Figure 6](#).
6. Note: J5 (CLK6) is configured as a divide-by-100 CMOS clock. This is used to verify EVM functionality.

3.5 TSW1400 Example Setup Procedure

1. Start the High Speed Converter Pro GUI program. When the program starts, select the DAC tab and then select DAC34SH84 device in the "Select DAC" menu.

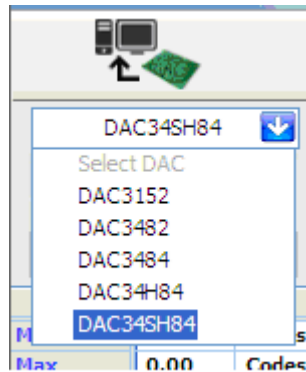

Figure 12. Select DAC34SH84 in the High Speed Converter Pro GUI Program

2. When prompted *Load DAC Firmware?*, select *YES*.

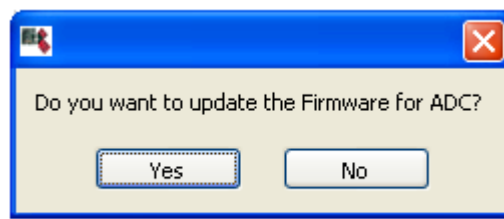

Figure 13. Load DAC Firmware Prompt

3. Click on the button labeled "Load File to transfer into TSW 1400", located near the top left of the GUI.

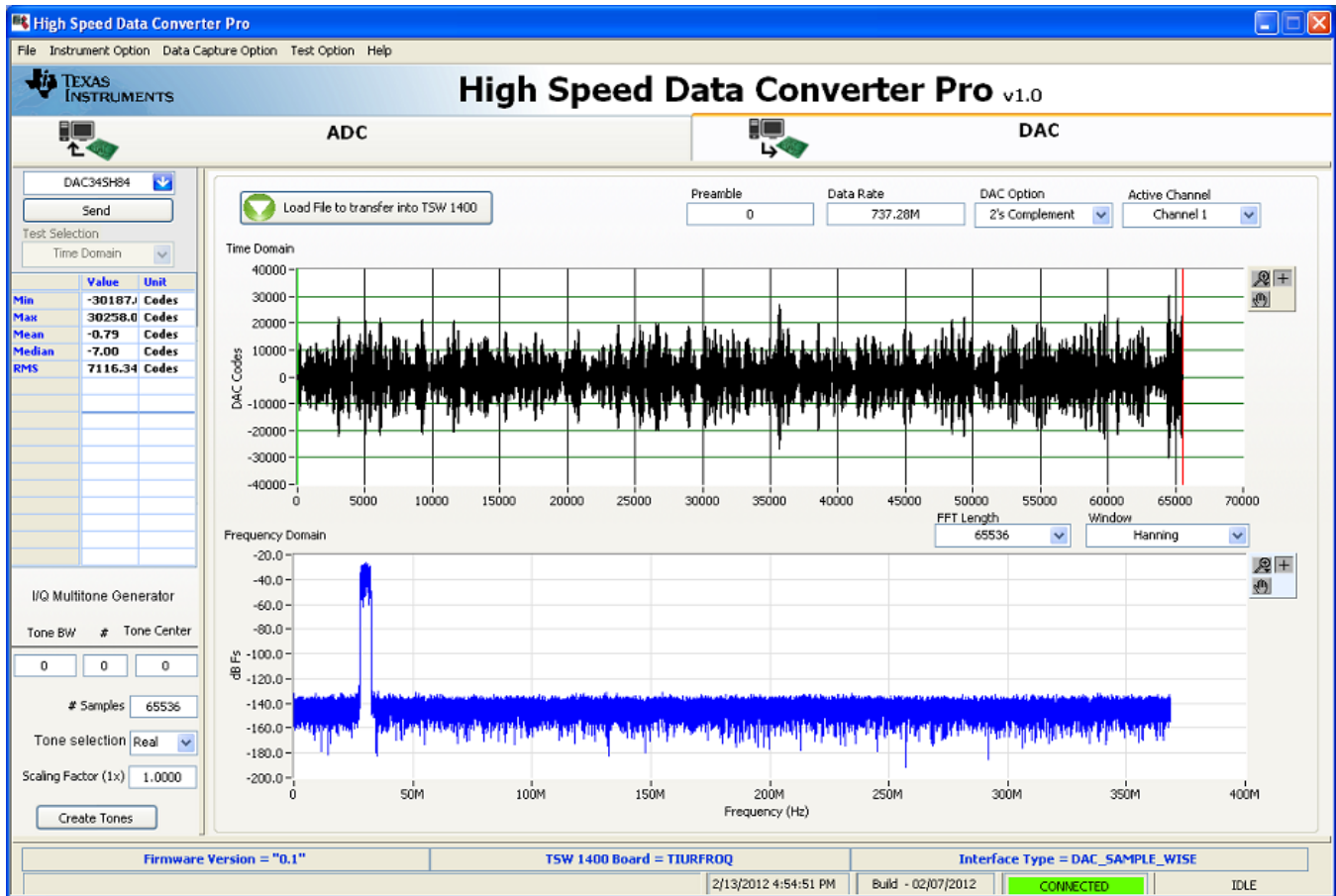
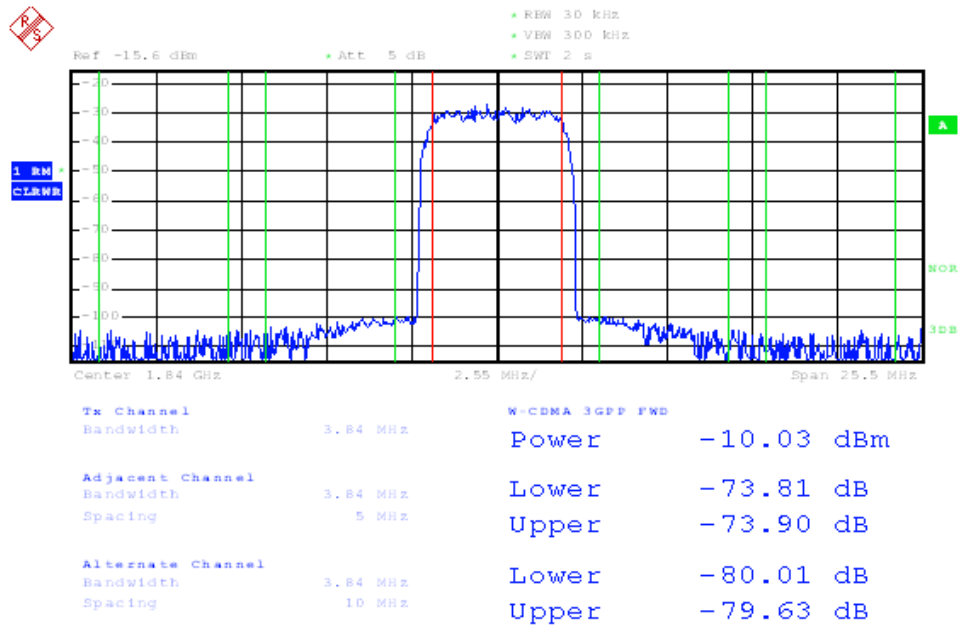

Figure 14. Load File to Transfer into TSW1400

4. Select the file "WCDMA_TM1_complexIF30MHz_Fdata737.28MHz_1000.tsw" under C:\Program Files\Texas Instruments\High Speed Data Converter Pro\1400 Details\Testfiles
5. Enter 737.28M for the "Data Rate" and 2's complement for the "DAC Option".
6. Select Hanning for "Window".
7. In the "DAC Selection" panel on the left side of the GUI, click on "Send" to load the data into memory.
8. **Toggle the SIF SYNC button of the TSW308x EVM GUI to synchronize the appropriate digital blocks, if the example file with NCO setting is used.**
9. Verify the spectrum using the spectrum analyzer at the two RF outputs, J7 and J9, of the TSW30SH84.
10. With 1780 MHz of LO, the expect results are shown in [Figure 15](#) (TRF3705 Low-Gain Mode) and [Figure 16](#) (TRF3705 High-Gain Mode).



NOTE: Baseband = 30 MHz, NCO = 30 MHz with NCO Gain disabled, QMC Gain = 1446, LO = 1780 MHz

Figure 15. TSW30SH84 WCDMA Output (TRF3705 Low-Gain Mode)

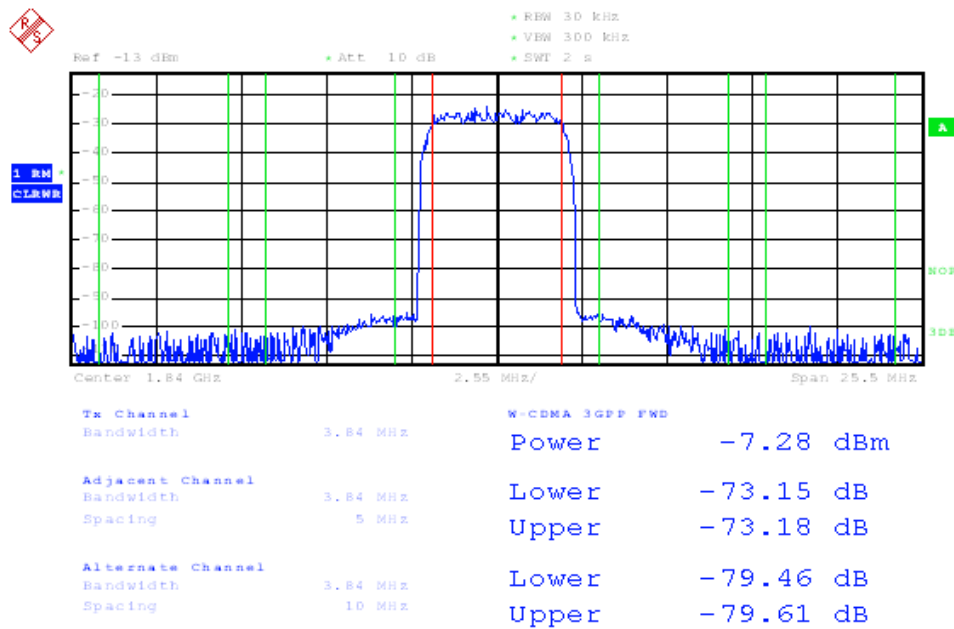

NOTE: Baseband = 30 MHz, NCO = 30 MHz with NCO Gain disabled, QMC Gain = 1446, LO = 1780 MHz

Figure 16. TSW30SH84 WCDMA Output (TRF3705 High-Gain Mode)

4 Basic Test Procedure with TSW3100

This section outlines the basic test procedure for testing the EVM with the TSW3100.

4.1 TSW3100 Overview

The TSW3100 is a high speed pattern generator board. The LVDS Bus rate is limited to 1.25GSPS, and this limits the maximum input data rate per channel of DAC34SH84 to 625MSPS. To evaluate the DAC34SH84 at 1.5GSPS DAC sampling rate, 4x or higher interpolation filter must be enabled. To evaluate the DAC34SH84 at 1.5GSPS DAC sampling rate with 2x interpolation filter (i.e. 750MSPS of input data rate per channel), the TSW1400 must be used.

See the TSW3100 user's guide ([SLLU101](#)) for more detailed explanations of the TSW3100 setup and operation. This document assumes that the TSW3100 software is installed and functioning properly. The TSW30SH84 needs TSW3100 operating software version 2.5 or higher with TSW3100 board Rev D (or higher).

The TSW308xEVM sends the FPGA reference clock to the FPGA of the TSW3100EVM in LVDS format. Therefore, a 100- Ω LVDS termination resistor is needed at the TSW3100 FPGA clock input. All the latest TSW3100EVMs from TI have the 100- Ω termination installed at the bottom side of the board on pins T31 and T32 of the FPGA. Contact TI Application Support if the 100- Ω termination is missing and assistance is needed for the 100- Ω installation.

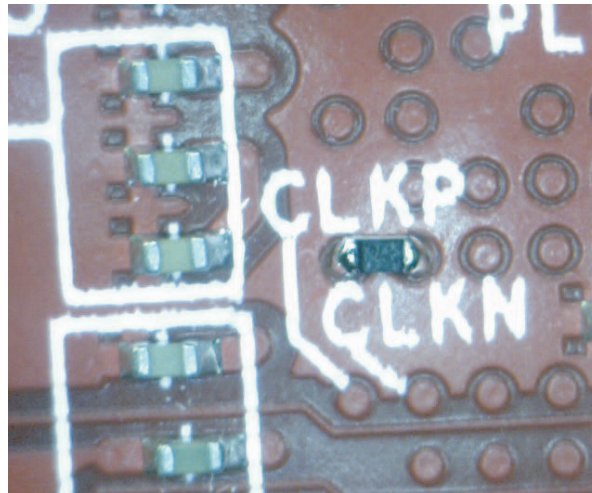

Figure 17. TSW3100 FPGA Clock 100- Ω LVDS Termination at Pins T31 and T32 of the FPGA

4.2 Test Block Diagram for TSW3100

The test setup for general testing of the TSW30SH84EVM with the TSW3100 pattern generation board is shown in [Figure 18](#).

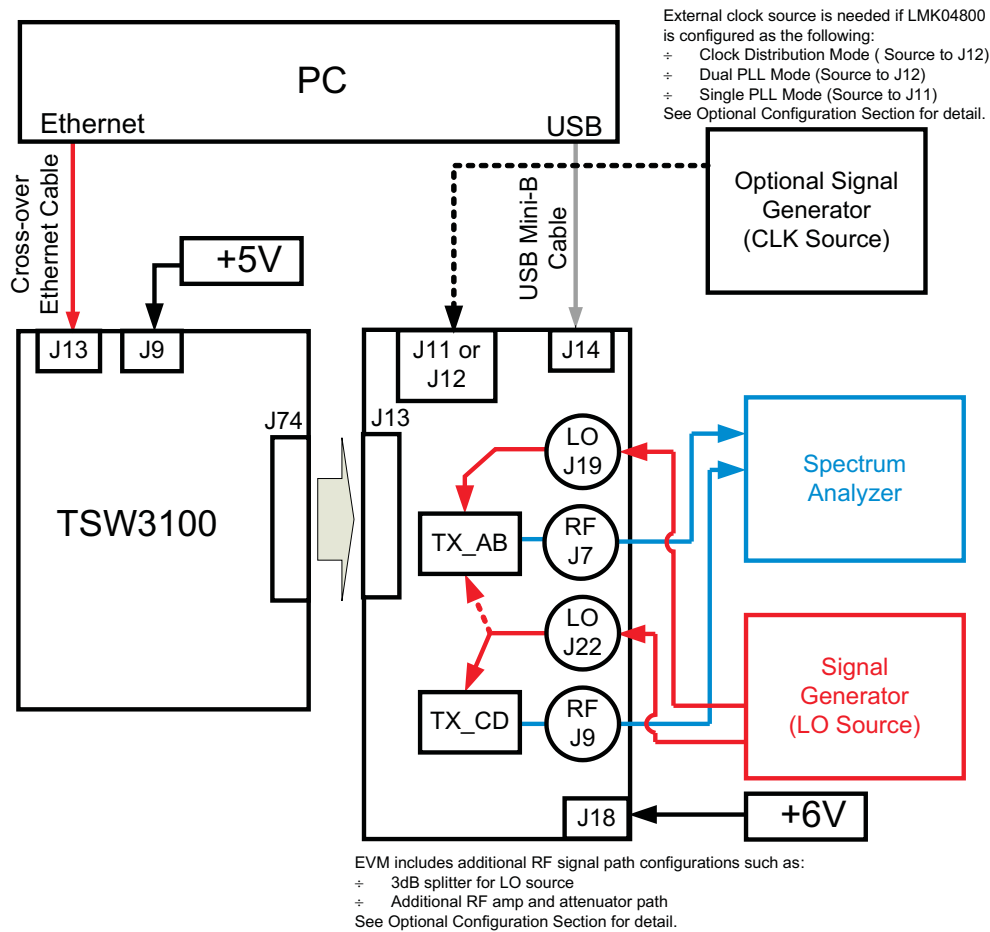

Figure 18. TSW3100 and TSW30SH84 Test Setup Block Diagram

4.3 Test Setup Connection

TSW3100 Pattern Generator

1. Connect 5-V power supply to J9, 5V_IN jack of the TSW3100EVM.
2. Connect the PC's Ethernet port to J13, Ethernet port of the TSW3100. The cable must be a standard crossover Cat5e Ethernet cable.

TSW30SH84EVM

1. Connect J13 connector of TSW30SH84EVM to J74 connector of TSW3100
2. See Section 3.3 Test Setup Connection for signal connections and jumper settings.

4.4 TSW30SH84 Example Setup Procedure

See Section 3.4 TSW30SH84 Example Setup Procedure for TSW30H84 Example setup for the GUI.

4.5 TSW3100 Example Setup Procedure

TSW3100 Single-Carrier WCDMA Output Example Setup

1. Start the TSW3100_CommsSignalPattern Software
2. Configure the TSW3100 to output a 368.64 MSPS, LVDS DDR format, 30-MHz IF Single-Carrier WCDMA output. See Figure 19 for details.
 - Change Interpolation value to DAC Clock Rate / Interpolation / 3.84 (i.e., $1474.56 / 4 / 3.84 = 192$)
 - Enter desired Offset Frequency (i.e., 30 MHz) for each desired carrier
 - Select the **LVDS** output button
 - Check the *LOAD and Run* box
 - Press the green *Create* button

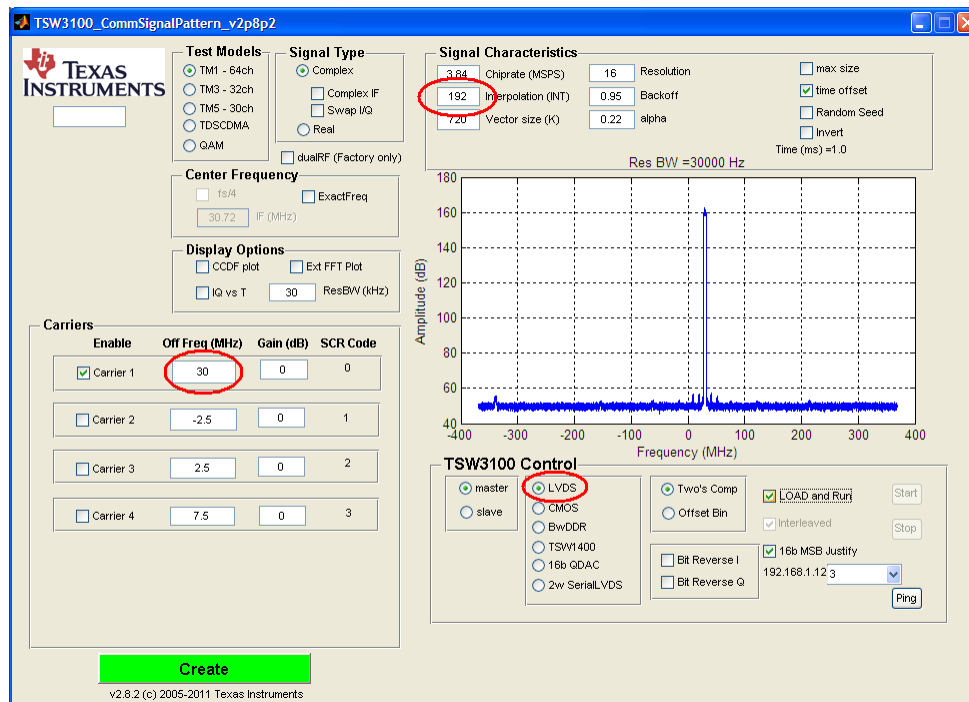

Figure 19. TSW3100 GUI for LVDS DDR Format

3. The interpolation setting of the DAC34SH84 must be set to 4x interpolation. The FPGA_CLK1 and FPGA_CLK2 must be adjusted to $F_{DAC}/16$.
4. **Toggle the SIF SYNC button of the TSW308x EVM GUI to synchronize the appropriate digital blocks, if example file with NCO setting is used.**
5. Verify the spectrum using the spectrum analyzer at the two RF outputs, J7 and J9, of the TSW30SH84.
6. With 1780 MHz of LO, the expect results are shown in Figure 15 (TRF3705 Low-Gain Mode) and Figure 16 (TRF3705 High-Gain Mode).

5 Optional Configuration

The onboard LMK04808B has the following configuration options for the flexible clocking of the DAC34SH84.



Figure 20. LMK04800 Mode Selection

5.1 Configuring the LMK04800 for Clock Distribution Mode

To use this mode:

- Provide a 2.4-Vpp maximum, 3.1-GHz maximum external clock at SMA J12.
- Select the *Clock Distribution* option in the LMK04800 Control tab.

5.2 Configuring the LMK04800 for Single PLL (PLL2 Only) Mode

To use this mode:

- The default reference is a 10-MHz crystal oscillator for the Single PLL mode. Set SJP5 to the 1-2 position.
- Optionally, a 3.3-Vpp maximum, 140-MHz maximum external reference can be applied at SMA J11. Set SJP5 to the 2-3 position.
- Select the *PLL2* options in the LMK04800 Control tab.

5.3 Configuring the LMK04800 for Dual PLL (PLL1 + PLL2) Mode.

To use this mode, the following steps must be made to the EVM:

- Replace oscillator Y1 with a VCXO, such as a FVXO-HC73 series 3.3V VCXO from Fox.
- For the TSW30H84EVM, install R273, R274, R90, C177, and C300.
- Provide an external reference at SMA J12.
- Select the Dual PLL options in the LMK04800 Control tab.

Consult the LMK04800 data sheet for proper device configuration for this mode of operation.

6 Transmit Path Optional Configuration

6.1 Shared LO Path

To share the LO source between the two transmit paths, the following configuration can be done:

- Install 0Ω to R192
- Install 17.4Ω to R190, R189, and R191
- Remove R188

6.2 Additional RF amp and attenuator path

To add additional gain and attenuation adjustment to the transmit path, the following configuration can be done:

For TX Path #1

- Remove C258 and R165
- Install 0Ω to R161, R163, and R293
- Install 0Ω or ferrite bead to FB23

For TX Path #2

- Remove C268 and R166
- Install 0Ω to R162, R164, and R294
- Install 0Ω or ferrite bead to FB21

With the default example pattern and LO of 1780MHz, the RF signal chain output can be measured at J7 and J9 connectors. The expected results are shown in [Figure 21](#) and [Figure 22](#).

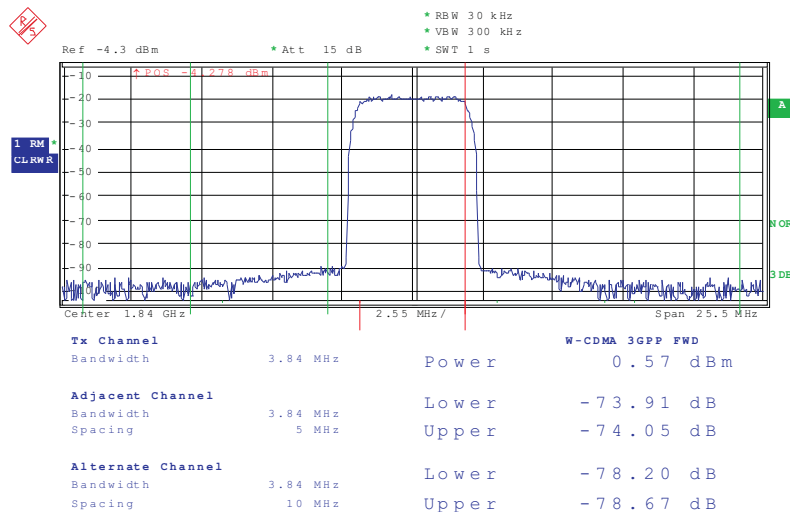

NOTE: Baseband = 30 MHz, NCO = 30 MHz with NCO Gain disabled, QMC Gain = 1446, LO = 1780 MHz

Figure 21. TSW30SH84 RF Amp / Attenuator Output (TRF3705 Low-Gain Mode)

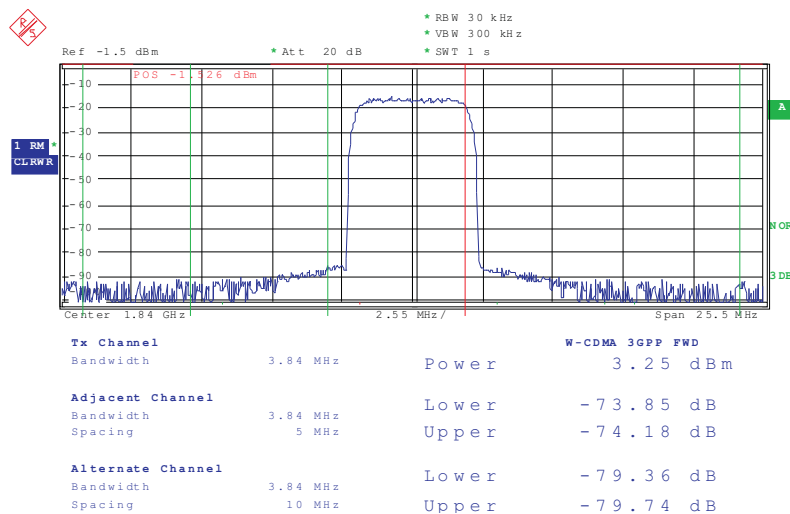

NOTE: Baseband = 30 MHz, NCO = 30 MHz with NCO Gain disabled, QMC Gain = 1446, LO = 1780 MHz

Figure 22. TSW30SH84 RF Amp / Attenuator Output (TRF3705 High-Gain Mode)

Matching components can be changed depending on the RF frequency range. See the schematic in the TSW30SH84 design package ([SLAC517](#)), TRF3705 data sheet ([SLWS223](#)), and the Avago MGA-30689 data sheet for details.

7 References

7.1 Related Products From Texas Instruments

Quad-Channel, 16-Bit, 1.5 GSPS Digital-to-Analog Converter (DAC) , DAC34SH84 ([SLAS808](#))

300-MHz to 4-GHz Quadrature Modulator, TRF3705 ([SLWS223](#))

LMK04800 Family Low-Noise Clock Jitter Cleaner with Dual Loop PLLs ([SNAS489](#))

7.2 Related Tools From Texas Instruments

TSW1400 High Speed Data Capture/Pattern Generator Card ([SLWU079](#))

TSW3100 High Speed Digital Pattern Generator ([SLUU101](#))

FMC-DAC-ADAPTER Physical Design Database Rev D Board ([SLOR102](#))

TSW30H84EVM Design Package board rev B ([SLAC517](#))

TSW308x EVM Software ([SLAC507](#))

High Speed Data Converter Pro software ([SLWC107](#))

EVALUATION BOARD/KIT/MODULE (EVM) ADDITIONAL TERMS

Texas Instruments (TI) provides the enclosed Evaluation Board/Kit/Module (EVM) under the following conditions:

The user assumes all responsibility and liability for proper and safe handling of the goods. Further, the user indemnifies TI from all claims arising from the handling or use of the goods.

Should this evaluation board/kit not meet the specifications indicated in the User's Guide, the board/ kit may be returned within 30 days from the date of delivery for a full refund. THE FOREGOING LIMITED WARRANTY IS THE EXCLUSIVE WARRANTY MADE BY SELLER TO BUYER AND IS IN LIEU OF ALL OTHER WARRANTIES, EXPRESSED, IMPLIED, OR STATUTORY, INCLUDING ANY WARRANTY OF MERCHANTABILITY OR FITNESS FOR ANY PARTICULAR PURPOSE. EXCEPT TO THE EXTENT OF THE INDEMNITY SET FORTH ABOVE, NEITHER PARTY SHALL BE LIABLE TO THE OTHER FOR ANY INDIRECT, SPECIAL, INCIDENTAL, OR CONSEQUENTIAL DAMAGES.

Please read the User's Guide and, specifically, the Warnings and Restrictions notice in the User's Guide prior to handling the product. This notice contains important safety information about temperatures and voltages. For additional information on TI's environmental and/or safety programs, please visit www.ti.com/esh or contact TI.

No license is granted under any patent right or other intellectual property right of TI covering or relating to any machine, process, or combination in which such TI products or services might be or are used. TI currently deals with a variety of customers for products, and therefore our arrangement with the user is not exclusive. TI assumes no liability for applications assistance, customer product design, software performance, or infringement of patents or services described herein.

REGULATORY COMPLIANCE INFORMATION

As noted in the EVM User's Guide and/or EVM itself, this EVM and/or accompanying hardware may or may not be subject to the Federal Communications Commission (FCC) and Industry Canada (IC) rules.

For EVMs **not** subject to the above rules, this evaluation board/kit/module is intended for use for ENGINEERING DEVELOPMENT, DEMONSTRATION OR EVALUATION PURPOSES ONLY and is not considered by TI to be a finished end product fit for general consumer use. It generates, uses, and can radiate radio frequency energy and has not been tested for compliance with the limits of computing devices pursuant to part 15 of FCC or ICES-003 rules, which are designed to provide reasonable protection against radio frequency interference. Operation of the equipment may cause interference with radio communications, in which case the user at his own expense will be required to take whatever measures may be required to correct this interference.

General Statement for EVMs including a radio

User Power/Frequency Use Obligations: This radio is intended for development/professional use only in legally allocated frequency and power limits. Any use of radio frequencies and/or power availability of this EVM and its development application(s) must comply with local laws governing radio spectrum allocation and power limits for this evaluation module. It is the user's sole responsibility to only operate this radio in legally acceptable frequency space and within legally mandated power limitations. Any exceptions to this is strictly prohibited and unauthorized by Texas Instruments unless user has obtained appropriate experimental/development licenses from local regulatory authorities, which is responsibility of user including its acceptable authorization.

For EVMs annotated as FCC – FEDERAL COMMUNICATIONS COMMISSION Part 15 Compliant

Caution

This device complies with part 15 of the FCC Rules. Operation is subject to the following two conditions: (1) This device may not cause harmful interference, and (2) this device must accept any interference received, including interference that may cause undesired operation

Changes or modifications not expressly approved by the party responsible for compliance could void the user's authority to operate the equipment.

FCC Interference Statement for Class A EVM devices

This equipment has been tested and found to comply with the limits for a Class A digital device, pursuant to part 15 of the FCC Rules. These limits are designed to provide reasonable protection against harmful interference when the equipment is operated in a commercial environment. This equipment generates, uses, and can radiate radio frequency energy and, if not installed and used in accordance with the instruction manual, may cause harmful interference to radio communications. Operation of this equipment in a residential area is likely to cause harmful interference in which case the user will be required to correct the interference at his own expense.

REGULATORY COMPLIANCE INFORMATION (continued)

FCC Interference Statement for Class B EVM devices

This equipment has been tested and found to comply with the limits for a Class B digital device, pursuant to part 15 of the FCC Rules. These limits are designed to provide reasonable protection against harmful interference in a residential installation. This equipment generates, uses and can radiate radio frequency energy and, if not installed and used in accordance with the instructions, may cause harmful interference to radio communications. However, there is no guarantee that interference will not occur in a particular installation. If this equipment does cause harmful interference to radio or television reception, which can be determined by turning the equipment off and on, the user is encouraged to try to correct the interference by one or more of the following measures:

- Reorient or relocate the receiving antenna.
- Increase the separation between the equipment and receiver.
- Connect the equipment into an outlet on a circuit different from that to which the receiver is connected.
- Consult the dealer or an experienced radio/TV technician for help.

For EVMs annotated as IC – INDUSTRY CANADA Compliant

This Class A or B digital apparatus complies with Canadian ICES-003.

Changes or modifications not expressly approved by the party responsible for compliance could void the user's authority to operate the equipment.

Concerning EVMs including radio transmitters

This device complies with Industry Canada licence-exempt RSS standard(s). Operation is subject to the following two conditions: (1) this device may not cause interference, and (2) this device must accept any interference, including interference that may cause undesired operation of the device.

Concerning EVMs including detachable antennas

Under Industry Canada regulations, this radio transmitter may only operate using an antenna of a type and maximum (or lesser) gain approved for the transmitter by Industry Canada. To reduce potential radio interference to other users, the antenna type and its gain should be so chosen that the equivalent isotropically radiated power (e.i.r.p.) is not more than that necessary for successful communication.

This radio transmitter has been approved by Industry Canada to operate with the antenna types listed in the user guide with the maximum permissible gain and required antenna impedance for each antenna type indicated. Antenna types not included in this list, having a gain greater than the maximum gain indicated for that type, are strictly prohibited for use with this device.

Cet appareil numérique de la classe A ou B est conforme à la norme NMB-003 du Canada.

Les changements ou les modifications pas expressément approuvés par la partie responsable de la conformité ont pu vider l'autorité de l'utilisateur pour actionner l'équipement.

Concernant les EVMs avec appareils radio

Le présent appareil est conforme aux CNR d'Industrie Canada applicables aux appareils radio exempts de licence. L'exploitation est autorisée aux deux conditions suivantes : (1) l'appareil ne doit pas produire de brouillage, et (2) l'utilisateur de l'appareil doit accepter tout brouillage radioélectrique subi, même si le brouillage est susceptible d'en compromettre le fonctionnement.

Concernant les EVMs avec antennes détachables

Conformément à la réglementation d'Industrie Canada, le présent émetteur radio peut fonctionner avec une antenne d'un type et d'un gain maximal (ou inférieur) approuvé pour l'émetteur par Industrie Canada. Dans le but de réduire les risques de brouillage radioélectrique à l'intention des autres utilisateurs, il faut choisir le type d'antenne et son gain de sorte que la puissance isotrope rayonnée équivalente (p.i.r.e.) ne dépasse pas l'intensité nécessaire à l'établissement d'une communication satisfaisante.

Le présent émetteur radio a été approuvé par Industrie Canada pour fonctionner avec les types d'antenne énumérés dans le manuel d'usage et ayant un gain admissible maximal et l'impédance requise pour chaque type d'antenne. Les types d'antenne non inclus dans cette liste, ou dont le gain est supérieur au gain maximal indiqué, sont strictement interdits pour l'exploitation de l'émetteur.

【Important Notice for Users of this Product in Japan】

This development kit is NOT certified as Confirming to Technical Regulations of Radio Law of Japan

If you use this product in Japan, you are required by Radio Law of Japan to follow the instructions below with respect to this product:

1. Use this product in a shielded room or any other test facility as defined in the notification #173 issued by Ministry of Internal Affairs and Communications on March 28, 2006, based on Sub-section 1.1 of Article 6 of the Ministry's Rule for Enforcement of Radio Law of Japan,
2. Use this product only after you obtained the license of Test Radio Station as provided in Radio Law of Japan with respect to this product, or
3. Use of this product only after you obtained the Technical Regulations Conformity Certification as provided in Radio Law of Japan with respect to this product. Also, please do not transfer this product, unless you give the same notice above to the transferee. Please note that if you could not follow the instructions above, you will be subject to penalties of Radio Law of Japan.

Texas Instruments Japan Limited
(address) 24-1, Nishi-Shinjuku 6 chome, Shinjuku-ku, Tokyo, Japan

<http://www.tij.co.jp>

【ご使用にあたっての注】

本開発キットは技術基準適合証明を受けておりません。

本製品のご使用に際しては、電波法遵守のため、以下のいずれかの措置を取っていただく必要がありますのでご注意ください。

1. 電波法施行規則第6条第1項第1号に基づく平成18年3月28日総務省告示第173号で定められた電波暗室等の試験設備でご使用いただく。
2. 実験局の免許を取得後ご使用いただく。
3. 技術基準適合証明を取得後ご使用いただく。

なお、本製品は、上記の「ご使用にあたっての注意」を譲渡先、移転先に通知しない限り、譲渡、移転できないものとします。

上記を遵守頂けない場合は、電波法の罰則が適用される可能性があることをご留意ください。

日本テキサス・インスツルメンツ株式会社
東京都新宿区西新宿 6 丁目 2 4 番 1 号
西新宿三井ビル

<http://www.tij.co.jp>

EVALUATION BOARD/KIT/MODULE (EVM) WARNINGS, RESTRICTIONS AND DISCLAIMERS

For Feasibility Evaluation Only, in Laboratory/Development Environments. Unless otherwise indicated, this EVM is not a finished electrical equipment and not intended for consumer use. It is intended solely for use for preliminary feasibility evaluation in laboratory/development environments by technically qualified electronics experts who are familiar with the dangers and application risks associated with handling electrical mechanical components, systems and subsystems. It should not be used as all or part of a finished end product.

Your Sole Responsibility and Risk. You acknowledge, represent and agree that:

1. You have unique knowledge concerning Federal, State and local regulatory requirements (including but not limited to Food and Drug Administration regulations, if applicable) which relate to your products and which relate to your use (and/or that of your employees, affiliates, contractors or designees) of the EVM for evaluation, testing and other purposes.
2. You have full and exclusive responsibility to assure the safety and compliance of your products with all such laws and other applicable regulatory requirements, and also to assure the safety of any activities to be conducted by you and/or your employees, affiliates, contractors or designees, using the EVM. Further, you are responsible to assure that any interfaces (electronic and/or mechanical) between the EVM and any human body are designed with suitable isolation and means to safely limit accessible leakage currents to minimize the risk of electrical shock hazard.
3. You will employ reasonable safeguards to ensure that your use of the EVM will not result in any property damage, injury or death, even if the EVM should fail to perform as described or expected.
4. You will take care of proper disposal and recycling of the EVM's electronic components and packing materials.

Certain Instructions. It is important to operate this EVM within TI's recommended specifications and environmental considerations per the user guidelines. Exceeding the specified EVM ratings (including but not limited to input and output voltage, current, power, and environmental ranges) may cause property damage, personal injury or death. If there are questions concerning these ratings please contact a TI field representative prior to connecting interface electronics including input power and intended loads. Any loads applied outside of the specified output range may result in unintended and/or inaccurate operation and/or possible permanent damage to the EVM and/or interface electronics. Please consult the EVM User's Guide prior to connecting any load to the EVM output. If there is uncertainty as to the load specification, please contact a TI field representative. During normal operation, some circuit components may have case temperatures greater than 60°C as long as the input and output are maintained at a normal ambient operating temperature. These components include but are not limited to linear regulators, switching transistors, pass transistors, and current sense resistors which can be identified using the EVM schematic located in the EVM User's Guide. When placing measurement probes near these devices during normal operation, please be aware that these devices may be very warm to the touch. As with all electronic evaluation tools, only qualified personnel knowledgeable in electronic measurement and diagnostics normally found in development environments should use these EVMs.

Agreement to Defend, Indemnify and Hold Harmless. You agree to defend, indemnify and hold TI, its licensors and their representatives harmless from and against any and all claims, damages, losses, expenses, costs and liabilities (collectively, "Claims") arising out of or in connection with any use of the EVM that is not in accordance with the terms of the agreement. This obligation shall apply whether Claims arise under law of tort or contract or any other legal theory, and even if the EVM fails to perform as described or expected.

Safety-Critical or Life-Critical Applications. If you intend to evaluate the components for possible use in safety critical applications (such as life support) where a failure of the TI product would reasonably be expected to cause severe personal injury or death, such as devices which are classified as FDA Class III or similar classification, then you must specifically notify TI of such intent and enter into a separate Assurance and Indemnity Agreement.

Mailing Address: Texas Instruments, Post Office Box 655303, Dallas, Texas 75265
Copyright © 2012, Texas Instruments Incorporated

EVALUATION BOARD/KIT/MODULE (EVM) ADDITIONAL TERMS

Texas Instruments (TI) provides the enclosed Evaluation Board/Kit/Module (EVM) under the following conditions:

The user assumes all responsibility and liability for proper and safe handling of the goods. Further, the user indemnifies TI from all claims arising from the handling or use of the goods.

Should this evaluation board/kit not meet the specifications indicated in the User's Guide, the board/kit may be returned within 30 days from the date of delivery for a full refund. THE FOREGOING LIMITED WARRANTY IS THE EXCLUSIVE WARRANTY MADE BY SELLER TO BUYER AND IS IN LIEU OF ALL OTHER WARRANTIES, EXPRESSED, IMPLIED, OR STATUTORY, INCLUDING ANY WARRANTY OF MERCHANTABILITY OR FITNESS FOR ANY PARTICULAR PURPOSE. EXCEPT TO THE EXTENT OF THE INDEMNITY SET FORTH ABOVE, NEITHER PARTY SHALL BE LIABLE TO THE OTHER FOR ANY INDIRECT, SPECIAL, INCIDENTAL, OR CONSEQUENTIAL DAMAGES.

Please read the User's Guide and, specifically, the Warnings and Restrictions notice in the User's Guide prior to handling the product. This notice contains important safety information about temperatures and voltages. For additional information on TI's environmental and/or safety programs, please visit www.ti.com/esh or contact TI.

No license is granted under any patent right or other intellectual property right of TI covering or relating to any machine, process, or combination in which such TI products or services might be or are used. TI currently deals with a variety of customers for products, and therefore our arrangement with the user is not exclusive. TI assumes no liability for applications assistance, customer product design, software performance, or infringement of patents or services described herein.

REGULATORY COMPLIANCE INFORMATION

As noted in the EVM User's Guide and/or EVM itself, this EVM and/or accompanying hardware may or may not be subject to the Federal Communications Commission (FCC) and Industry Canada (IC) rules.

For EVMs **not** subject to the above rules, this evaluation board/kit/module is intended for use for ENGINEERING DEVELOPMENT, DEMONSTRATION OR EVALUATION PURPOSES ONLY and is not considered by TI to be a finished end product fit for general consumer use. It generates, uses, and can radiate radio frequency energy and has not been tested for compliance with the limits of computing devices pursuant to part 15 of FCC or ICES-003 rules, which are designed to provide reasonable protection against radio frequency interference. Operation of the equipment may cause interference with radio communications, in which case the user at his own expense will be required to take whatever measures may be required to correct this interference.

General Statement for EVMs including a radio

User Power/Frequency Use Obligations: This radio is intended for development/professional use only in legally allocated frequency and power limits. Any use of radio frequencies and/or power availability of this EVM and its development application(s) must comply with local laws governing radio spectrum allocation and power limits for this evaluation module. It is the user's sole responsibility to only operate this radio in legally acceptable frequency space and within legally mandated power limitations. Any exceptions to this are strictly prohibited and unauthorized by Texas Instruments unless user has obtained appropriate experimental/development licenses from local regulatory authorities, which is responsibility of user including its acceptable authorization.

For EVMs annotated as FCC – FEDERAL COMMUNICATIONS COMMISSION Part 15 Compliant

Caution

This device complies with part 15 of the FCC Rules. Operation is subject to the following two conditions: (1) This device may not cause harmful interference, and (2) this device must accept any interference received, including interference that may cause undesired operation.

Changes or modifications not expressly approved by the party responsible for compliance could void the user's authority to operate the equipment.

FCC Interference Statement for Class A EVM devices

This equipment has been tested and found to comply with the limits for a Class A digital device, pursuant to part 15 of the FCC Rules. These limits are designed to provide reasonable protection against harmful interference when the equipment is operated in a commercial environment. This equipment generates, uses, and can radiate radio frequency energy and, if not installed and used in accordance with the instruction manual, may cause harmful interference to radio communications. Operation of this equipment in a residential area is likely to cause harmful interference in which case the user will be required to correct the interference at his own expense.

FCC Interference Statement for Class B EVM devices

This equipment has been tested and found to comply with the limits for a Class B digital device, pursuant to part 15 of the FCC Rules. These limits are designed to provide reasonable protection against harmful interference in a residential installation. This equipment generates, uses and can radiate radio frequency energy and, if not installed and used in accordance with the instructions, may cause harmful interference to radio communications. However, there is no guarantee that interference will not occur in a particular installation. If this equipment does cause harmful interference to radio or television reception, which can be determined by turning the equipment off and on, the user is encouraged to try to correct the interference by one or more of the following measures:

- Reorient or relocate the receiving antenna.
- Increase the separation between the equipment and receiver.
- Connect the equipment into an outlet on a circuit different from that to which the receiver is connected.
- Consult the dealer or an experienced radio/TV technician for help.

For EVMs annotated as IC – INDUSTRY CANADA Compliant

This Class A or B digital apparatus complies with Canadian ICES-003.

Changes or modifications not expressly approved by the party responsible for compliance could void the user's authority to operate the equipment.

Concerning EVMs including radio transmitters

This device complies with Industry Canada licence-exempt RSS standard(s). Operation is subject to the following two conditions: (1) this device may not cause interference, and (2) this device must accept any interference, including interference that may cause undesired operation of the device.

Concerning EVMs including detachable antennas

Under Industry Canada regulations, this radio transmitter may only operate using an antenna of a type and maximum (or lesser) gain approved for the transmitter by Industry Canada. To reduce potential radio interference to other users, the antenna type and its gain should be so chosen that the equivalent isotropically radiated power (e.i.r.p.) is not more than that necessary for successful communication.

This radio transmitter has been approved by Industry Canada to operate with the antenna types listed in the user guide with the maximum permissible gain and required antenna impedance for each antenna type indicated. Antenna types not included in this list, having a gain greater than the maximum gain indicated for that type, are strictly prohibited for use with this device.

Cet appareil numérique de la classe A ou B est conforme à la norme NMB-003 du Canada.

Les changements ou les modifications pas expressément approuvés par la partie responsable de la conformité ont pu vider l'autorité de l'utilisateur pour actionner l'équipement.

Concernant les EVMs avec appareils radio

Le présent appareil est conforme aux CNR d'Industrie Canada applicables aux appareils radio exempts de licence. L'exploitation est autorisée aux deux conditions suivantes : (1) l'appareil ne doit pas produire de brouillage, et (2) l'utilisateur de l'appareil doit accepter tout brouillage radioélectrique subi, même si le brouillage est susceptible d'en compromettre le fonctionnement.

Concernant les EVMs avec antennes détachables

Conformément à la réglementation d'Industrie Canada, le présent émetteur radio peut fonctionner avec une antenne d'un type et d'un gain maximal (ou inférieur) approuvé pour l'émetteur par Industrie Canada. Dans le but de réduire les risques de brouillage radioélectrique à l'intention des autres utilisateurs, il faut choisir le type d'antenne et son gain de sorte que la puissance isotrope rayonnée équivalente (p.i.r.e.) ne dépasse pas l'intensité nécessaire à l'établissement d'une communication satisfaisante.

Le présent émetteur radio a été approuvé par Industrie Canada pour fonctionner avec les types d'antenne énumérés dans le manuel d'usage et ayant un gain admissible maximal et l'impédance requise pour chaque type d'antenne. Les types d'antenne non inclus dans cette liste, ou dont le gain est supérieur au gain maximal indiqué, sont strictement interdits pour l'exploitation de l'émetteur.

【Important Notice for Users of this Product in Japan】

This development kit is NOT certified as Confirming to Technical Regulations of Radio Law of Japan

If you use this product in Japan, you are required by Radio Law of Japan to follow the instructions below with respect to this product:

1. Use this product in a shielded room or any other test facility as defined in the notification #173 issued by Ministry of Internal Affairs and Communications on March 28, 2006, based on Sub-section 1.1 of Article 6 of the Ministry's Rule for Enforcement of Radio Law of Japan,
2. Use this product only after you obtained the license of Test Radio Station as provided in Radio Law of Japan with respect to this product, or
3. Use of this product only after you obtained the Technical Regulations Conformity Certification as provided in Radio Law of Japan with respect to this product. Also, please do not transfer this product, unless you give the same notice above to the transferee. Please note that if you could not follow the instructions above, you will be subject to penalties of Radio Law of Japan.

Texas Instruments Japan Limited
(address) 24-1, Nishi-Shinjuku 6 chome, Shinjuku-ku, Tokyo, Japan

<http://www.tij.co.jp>

【ご使用にあたっての注】

本開発キットは技術基準適合証明を受けておりません。

本製品のご使用に際しては、電波法遵守のため、以下のいずれかの措置を取っていただく必要がありますのでご注意ください。

1. 電波法施行規則第6条第1項第1号に基づく平成18年3月28日総務省告示第173号で定められた電波暗室等の試験設備でご使用いただく。
2. 実験局の免許を取得後ご使用いただく。
3. 技術基準適合証明を取得後ご使用いただく。

なお、本製品は、上記の「ご使用にあたっての注意」を譲渡先、移転先に通知しない限り、譲渡、移転できないものとします。

上記を遵守頂けない場合は、電波法の罰則が適用される可能性があることをご留意ください。

日本テキサス・インスツルメンツ株式会社
東京都新宿区西新宿6丁目24番1号
西新宿三井ビル

<http://www.tij.co.jp>

EVALUATION BOARD/KIT/MODULE (EVM) WARNINGS, RESTRICTIONS AND DISCLAIMERS

For Feasibility Evaluation Only, in Laboratory/Development Environments. Unless otherwise indicated, this EVM is not a finished electrical equipment and not intended for consumer use. It is intended solely for use for preliminary feasibility evaluation in laboratory/development environments by technically qualified electronics experts who are familiar with the dangers and application risks associated with handling electrical mechanical components, systems and subsystems. It should not be used as all or part of a finished end product.

Your Sole Responsibility and Risk. You acknowledge, represent and agree that:

1. You have unique knowledge concerning Federal, State and local regulatory requirements (including but not limited to Food and Drug Administration regulations, if applicable) which relate to your products and which relate to your use (and/or that of your employees, affiliates, contractors or designees) of the EVM for evaluation, testing and other purposes.
2. You have full and exclusive responsibility to assure the safety and compliance of your products with all such laws and other applicable regulatory requirements, and also to assure the safety of any activities to be conducted by you and/or your employees, affiliates, contractors or designees, using the EVM. Further, you are responsible to assure that any interfaces (electronic and/or mechanical) between the EVM and any human body are designed with suitable isolation and means to safely limit accessible leakage currents to minimize the risk of electrical shock hazard.
3. You will employ reasonable safeguards to ensure that your use of the EVM will not result in any property damage, injury or death, even if the EVM should fail to perform as described or expected.
4. You will take care of proper disposal and recycling of the EVM's electronic components and packing materials.

Certain Instructions. It is important to operate this EVM within TI's recommended specifications and environmental considerations per the user guidelines. Exceeding the specified EVM ratings (including but not limited to input and output voltage, current, power, and environmental ranges) may cause property damage, personal injury or death. If there are questions concerning these ratings please contact a TI field representative prior to connecting interface electronics including input power and intended loads. Any loads applied outside of the specified output range may result in unintended and/or inaccurate operation and/or possible permanent damage to the EVM and/or interface electronics. Please consult the EVM User's Guide prior to connecting any load to the EVM output. If there is uncertainty as to the load specification, please contact a TI field representative. During normal operation, some circuit components may have case temperatures greater than 60°C as long as the input and output are maintained at a normal ambient operating temperature. These components include but are not limited to linear regulators, switching transistors, pass transistors, and current sense resistors which can be identified using the EVM schematic located in the EVM User's Guide. When placing measurement probes near these devices during normal operation, please be aware that these devices may be very warm to the touch. As with all electronic evaluation tools, only qualified personnel knowledgeable in electronic measurement and diagnostics normally found in development environments should use these EVMs.

Agreement to Defend, Indemnify and Hold Harmless. You agree to defend, indemnify and hold TI, its licensors and their representatives harmless from and against any and all claims, damages, losses, expenses, costs and liabilities (collectively, "Claims") arising out of or in connection with any use of the EVM that is not in accordance with the terms of the agreement. This obligation shall apply whether Claims arise under law of tort or contract or any other legal theory, and even if the EVM fails to perform as described or expected.

Safety-Critical or Life-Critical Applications. If you intend to evaluate the components for possible use in safety critical applications (such as life support) where a failure of the TI product would reasonably be expected to cause severe personal injury or death, such as devices which are classified as FDA Class III or similar classification, then you must specifically notify TI of such intent and enter into a separate Assurance and Indemnity Agreement.

Mailing Address: Texas Instruments, Post Office Box 655303, Dallas, Texas 75265
Copyright © 2012, Texas Instruments Incorporated

IMPORTANT NOTICE

Texas Instruments Incorporated and its subsidiaries (TI) reserve the right to make corrections, enhancements, improvements and other changes to its semiconductor products and services per JESD46, latest issue, and to discontinue any product or service per JESD48, latest issue. Buyers should obtain the latest relevant information before placing orders and should verify that such information is current and complete. All semiconductor products (also referred to herein as "components") are sold subject to TI's terms and conditions of sale supplied at the time of order acknowledgment.

TI warrants performance of its components to the specifications applicable at the time of sale, in accordance with the warranty in TI's terms and conditions of sale of semiconductor products. Testing and other quality control techniques are used to the extent TI deems necessary to support this warranty. Except where mandated by applicable law, testing of all parameters of each component is not necessarily performed.

TI assumes no liability for applications assistance or the design of Buyers' products. Buyers are responsible for their products and applications using TI components. To minimize the risks associated with Buyers' products and applications, Buyers should provide adequate design and operating safeguards.

TI does not warrant or represent that any license, either express or implied, is granted under any patent right, copyright, mask work right, or other intellectual property right relating to any combination, machine, or process in which TI components or services are used. Information published by TI regarding third-party products or services does not constitute a license to use such products or services or a warranty or endorsement thereof. Use of such information may require a license from a third party under the patents or other intellectual property of the third party, or a license from TI under the patents or other intellectual property of TI.

Reproduction of significant portions of TI information in TI data books or data sheets is permissible only if reproduction is without alteration and is accompanied by all associated warranties, conditions, limitations, and notices. TI is not responsible or liable for such altered documentation. Information of third parties may be subject to additional restrictions.

Resale of TI components or services with statements different from or beyond the parameters stated by TI for that component or service voids all express and any implied warranties for the associated TI component or service and is an unfair and deceptive business practice. TI is not responsible or liable for any such statements.

Buyer acknowledges and agrees that it is solely responsible for compliance with all legal, regulatory and safety-related requirements concerning its products, and any use of TI components in its applications, notwithstanding any applications-related information or support that may be provided by TI. Buyer represents and agrees that it has all the necessary expertise to create and implement safeguards which anticipate dangerous consequences of failures, monitor failures and their consequences, lessen the likelihood of failures that might cause harm and take appropriate remedial actions. Buyer will fully indemnify TI and its representatives against any damages arising out of the use of any TI components in safety-critical applications.

In some cases, TI components may be promoted specifically to facilitate safety-related applications. With such components, TI's goal is to help enable customers to design and create their own end-product solutions that meet applicable functional safety standards and requirements. Nonetheless, such components are subject to these terms.

No TI components are authorized for use in FDA Class III (or similar life-critical medical equipment) unless authorized officers of the parties have executed a special agreement specifically governing such use.

Only those TI components which TI has specifically designated as military grade or "enhanced plastic" are designed and intended for use in military/aerospace applications or environments. Buyer acknowledges and agrees that any military or aerospace use of TI components which have **not** been so designated is solely at the Buyer's risk, and that Buyer is solely responsible for compliance with all legal and regulatory requirements in connection with such use.

TI has specifically designated certain components which meet ISO/TS16949 requirements, mainly for automotive use. Components which have not been so designated are neither designed nor intended for automotive use; and TI will not be responsible for any failure of such components to meet such requirements.

Products

Audio	www.ti.com/audio
Amplifiers	amplifier.ti.com
Data Converters	dataconverter.ti.com
DLP® Products	www.dlp.com
DSP	dsp.ti.com
Clocks and Timers	www.ti.com/clocks
Interface	interface.ti.com
Logic	logic.ti.com
Power Mgmt	power.ti.com
Microcontrollers	microcontroller.ti.com
RFID	www.ti-rfid.com
OMAP Applications Processors	www.ti.com/omap
Wireless Connectivity	www.ti.com/wirelessconnectivity

Applications

Automotive and Transportation	www.ti.com/automotive
Communications and Telecom	www.ti.com/communications
Computers and Peripherals	www.ti.com/computers
Consumer Electronics	www.ti.com/consumer-apps
Energy and Lighting	www.ti.com/energy
Industrial	www.ti.com/industrial
Medical	www.ti.com/medical
Security	www.ti.com/security
Space, Avionics and Defense	www.ti.com/space-avionics-defense
Video and Imaging	www.ti.com/video

TI E2E Community

e2e.ti.com