

# ***LVC Characterization Information***

SCBA011  
December 1996



## **IMPORTANT NOTICE**

Texas Instruments (TI) reserves the right to make changes to its products or to discontinue any semiconductor product or service without notice, and advises its customers to obtain the latest version of relevant information to verify, before placing orders, that the information being relied on is current.

TI warrants performance of its semiconductor products and related software to the specifications applicable at the time of sale in accordance with TI's standard warranty. Testing and other quality control techniques are utilized to the extent TI deems necessary to support this warranty. Specific testing of all parameters of each device is not necessarily performed, except those mandated by government requirements.

Certain applications using semiconductor products may involve potential risks of death, personal injury, or severe property or environmental damage ("Critical Applications").

**TI SEMICONDUCTOR PRODUCTS ARE NOT DESIGNED, INTENDED, AUTHORIZED, OR WARRANTED TO BE SUITABLE FOR USE IN LIFE-SUPPORT APPLICATIONS, DEVICES OR SYSTEMS OR OTHER CRITICAL APPLICATIONS.**

Inclusion of TI products in such applications is understood to be fully at the risk of the customer. Use of TI products in such applications requires the written approval of an appropriate TI officer. Questions concerning potential risk applications should be directed to TI through a local SC sales office.

In order to minimize risks associated with the customer's applications, adequate design and operating safeguards should be provided by the customer to minimize inherent or procedural hazards.

TI assumes no liability for applications assistance, customer product design, software performance, or infringement of patents or services described herein. Nor does TI warrant or represent that any license, either express or implied, is granted under any patent right, copyright, mask work right, or other intellectual property right of TI covering or relating to any combination, machine, or process in which such semiconductor products or services might be or are used.

## Contents

<i>Title</i>	<i>Page</i>
<b>Introduction</b> .....	<b>1</b>
The Case for Low Voltage .....	1
<b>Considerations for Interfacing to 5-V Logic</b> .....	<b>2</b>
Case 1 .....	4
Case 2 .....	4
Case 3 .....	4
Case 4 .....	4
<b>ac Performance</b> .....	<b>5</b>
<b>Power Considerations</b> .....	<b>9</b>
<b>Input Characteristics</b> .....	<b>11</b>
LVC Input Circuitry .....	11
Input Current Loading .....	13
Supply Current Change ( $\Delta I_{CC}$ ) .....	14
Proper Termination of Unused Inputs and Bus Hold .....	14
<b>Output Characteristics</b> .....	<b>15</b>
LVC Output Circuitry .....	16
Output Drive .....	16
Partial Power Down .....	16
Proper Termination of Outputs .....	16
Technique 1 .....	17
Technique 2 .....	17
Technique 3 .....	17
Technique 4 .....	18
Technique 5 .....	18
<b>Signal Integrity</b> .....	<b>19</b>
<b>Acknowledgment</b> .....	<b>19</b>

## List of Illustrations

<i>Figure</i>	<i>Title</i>	<i>Page</i>
1	Comparison of 5-V CMOS, 5-V TTL, and 3.3-V TTL Switching Standards .....	2
2	Summary of Four Cases When Interfacing 3.3-V Devices With 5-V Devices .....	3
3	Propagation Delay Time Versus Operating Free-Air Temperature .....	5
4	Propagation Delay Time Versus Number of Outputs Switching .....	7
5	Propagation Delay Time Versus Load Capacitance .....	8
6	$I_{CC}$ Versus Frequency .....	10
7	Supply Current Versus Input Voltage .....	11
8	Simplified Input Stage of an LVC Circuit .....	11
9	Output Voltage Versus Input Voltage .....	12
10	Input Current Versus Input Voltage .....	12
11	Input Leakage Current Versus Input Voltage .....	13
12	Bus Hold .....	14
13	$I_{I(\text{hold})}$ Versus $V_I$ .....	15
14	Simplified Output Stage of an LVC Circuit .....	16
15	Typical LVC Output Characteristics .....	16
16	Termination Techniques .....	17
17	Simultaneous Switching Noise Waveform .....	19

## List of Tables

<i>Table</i>	<i>Title</i>	<i>Page</i>
1	Input Current Specifications .....	13
2	$\Delta I_{CC}$ Current Specifications .....	14
3	Bus-Hold Specifications [ $I_{I(\text{hold})}$ ] .....	15
4	LVC Output Specifications .....	15
5	Termination Techniques Summary .....	18

## Introduction

### The Case for Low Voltage

LVL, or low-voltage logic, in the context of this application report, refers to devices designed specifically to operate from a 3.3-V power supply. Initially, an alternative method of achieving low-voltage operation was to use a device designed for 5-V operation, but power it with a 3.3-V supply. Although this resulted in 3.3-V characteristics, this method resulted in significantly slower propagation time. Subsequently, parts were designed to operate using a 3.3-V power supply.

A primary benefit of using a 3.3-V power supply as opposed to the traditional 5-V power supply is the reduced power consumption. Because power consumption is a function of the load capacitance, the frequency of operation, and the supply voltage, a reduction in any one of these is beneficial. Supply voltage has a square relationship in the reduction of power consumed, whereas load capacitance and frequency of operation have a linear effect. As a result, a small decrease in the supply voltage yields significant reduction in the power consumption. Equation 1 provides the dynamic component of the power calculation. (The calculation for computing the total power consumed is provided in *Power Considerations*.)

$$P_D(\text{dynamic}) = [(C_{pd} + C_L) \times V_{CC}^2 \times f] N_{sw} \quad (1)$$

Where:

- $C_{pd}$  = Power dissipation capacitance (F)
- $C_L$  = External load capacitance (F)
- $V_{CC}$  = Supply voltage (V)
- $f$  = Operating frequency (Hz)
- $N_{sw}$  = Total number of outputs switching

A reduction of power consumption provides several other benefits. Less heat is generated, which reduces problems associated with high temperature. This may provide the consumer with a product that costs less. Furthermore, the reliability of the system is increased due to lower temperature stress gradients on the device, and the integrity of the signal is improved due to the reduction of ground bounce and signal noise. An additional benefit of the reduced power consumption is the extended life of the battery when a system is not powered by a regulated power supply.

Although a complete migration may not be feasible for a particular application, beginning to integrate 3.3-V components in a system still has benefits. If system parts are designed using 3.3-V parts, then when the remaining parts become available, converting the system completely to 3.3-V parts is a much smaller task. For example, having the internal parts of a personal computer powered from a 3.3-V power supply while having the memory powered from a 5-V power supply is a fairly common current configuration. Although LVL devices are not used throughout the entire design, this system is easily adapted to a complete 3.3-V system when 3.3-V memory becomes cost effective.

## Considerations for Interfacing to 5-V Logic

Interfacing 3.3-V devices to 5-V devices requires consideration of the logic switching levels of the driver and the receiver. Figure 1 illustrates the various switching standards for 5-V CMOS, 5-V TTL, and 3.3-V TTL. The switching levels for the 5-V TTL and the 3.3-V TTL are identical, whereas the 5-V CMOS switching levels are different. The impact of this must be considered when interfacing 3.3-V systems with 5-V systems.

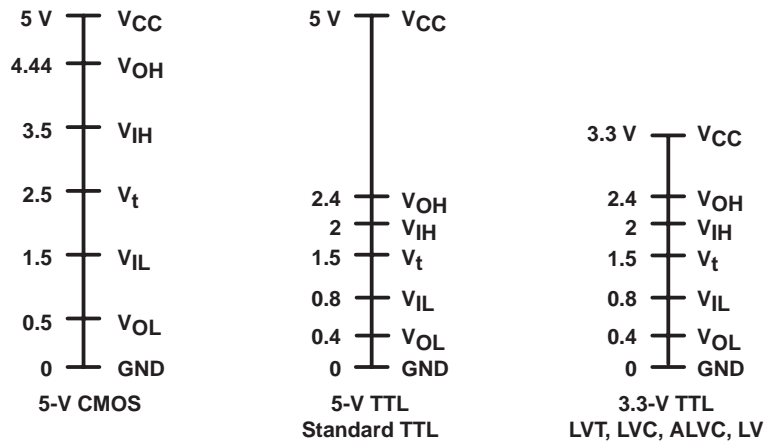

**Figure 1. Comparison of 5-V CMOS, 5-V TTL, and 3.3-V TTL Switching Standards**

Depending on the specific parts used in a system, four different cases can result. These cases are illustrated in Figure 2.

**Case 1: 5-V TTL Device Driving 3.3-V TTL Device (LVC)**

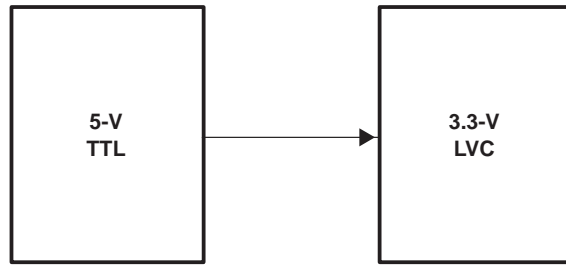

**Case 2: 3.3-V TTL Device (LVC) Driving 5-V TTL Device**

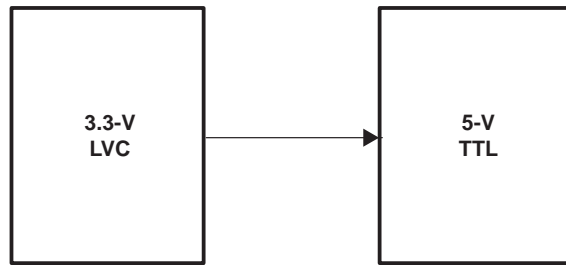

**Case 3: 5-V CMOS Device Driving 3.3-V TTL Device (LVC)**

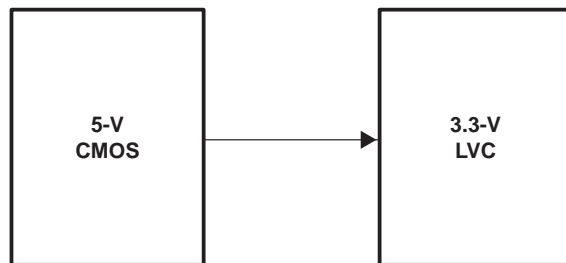

**Case 4: 3.3-V TTL Device (LVC) Driving 5-V CMOS Device**

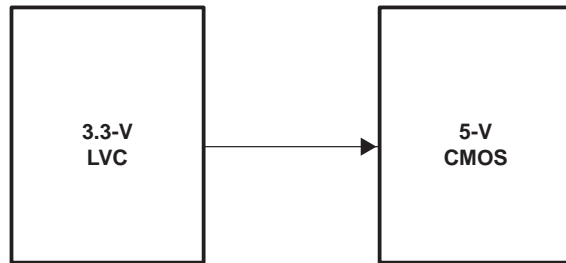

**Figure 2. Summary of Four Cases When Interfacing 3.3-V Devices With 5-V Devices**

### Case 1

Case 1 addresses a 5-V TTL device driving a 3.3-V TTL device. As shown in Figure 1, the switching levels for 5-V TTL and 3.3-V LVC are the same. Since 5-V tolerant devices can withstand a dc input of 6.5 V, interfacing these two devices does not require additional components or further design efforts.

TI's crossbar technology (CBT) switches can be used to translate from 5-V TTL to 3.3-V devices that are not 5-V tolerant. This is accomplished by using an external diode to create a 0.7-V drop (reducing 5 V to 4.3 V) with the CBT (of which the field effect transistor has a gate-to-source voltage drop of 1 V) that results in a net 3.3-V level. TI produces a CBTD device that incorporates the diode as part of the chip, thereby eliminating the need for an external diode.

### Case 2

Case 2 occurs when a 3.3-V TTL device (LVC) drives a 5-V TTL device. The switching levels are the same and it is possible to interface in this configuration without additional circuitry or devices. Driving a 5-V device from a 3.3-V device without additional complications or circuitry may seem odd, but as long as the 3.3-V device produces  $V_{OH}$  and  $V_{OL}$  levels of 2.4 V and 0.4 V, the input of the 5-V device reads them as valid levels since  $V_{IH}$  and  $V_{IL}$  are 2 V and 0.8 V.

### Case 3

Case 3 occurs when a 5-V CMOS device drives a 3.3-V TTL device (LVC). Two different switching standards that do not match (see Figure 1) are interfacing. Upon further analysis of the 5-V CMOS  $V_{OH}$  and  $V_{OL}$  and the 3.3-V LVC  $V_{IH}$  and  $V_{IL}$  switching levels, Figure 1 shows that although a disparity exists, a 5-V tolerant 3.3-V device can function properly with 5-V CMOS input levels. With a 5-V tolerant LVC device, the configuration of a 5-V CMOS part driving a 3.3-V LVC part is possible.

### Case 4

Case 4 occurs when a 3.3-V TTL device (LVC) drives a 5-V CMOS device. Two different switching standards are interfacing. As shown in Figure 1, the specified  $V_{OH}$  for a 3.3-V LVC is 2.4 V (higher output levels up to 3.3 V are possible), whereas the minimum required  $V_{IH}$  for a 5-V CMOS device is 3.5 V. As such, driving a 5-V CMOS device with a 3.3-V LVC (or any other standard 3.3-V logic) device is impossible because, even at the maximum  $V_{OH}$  of 3.3 V, the minimum  $V_{IH}$  of 3.5 V is never attained. To accommodate this occurrence, TI designed a series of split-rail devices; e.g., the SN74ALVC164245 and the SN74LVC4245, which have one side of the device powered at a 3.3-V level and the other side powered at a 5-V level. By having two different power supplies on the same device, the minimum voltage levels required for switching can be met and a 3.3-V logic part can essentially drive a 5-V CMOS device.



## ac Performance

A desirable objective is for systems to operate at faster speeds that allow less time for performing operations. For example, consider the impact a continually increasing operating frequency has on accessing memory or on performing arithmetic computations; the faster the system runs, the less time is available for other support functions to be performed.

To meet this need, advances have been made in the fabrication of integrated circuits (ICs). Specifically in the low-voltage arena, the LV, LVC, ALVC, and LVT logic family fabrication geometries have undergone changes that have consistently improved their performance. This is shown in Figures 3 through 5, which compare the propagation delay times of LV, LVC, ALVC, and LVT devices for differing values of operating free-air temperature, number of outputs switching, and load capacitance.

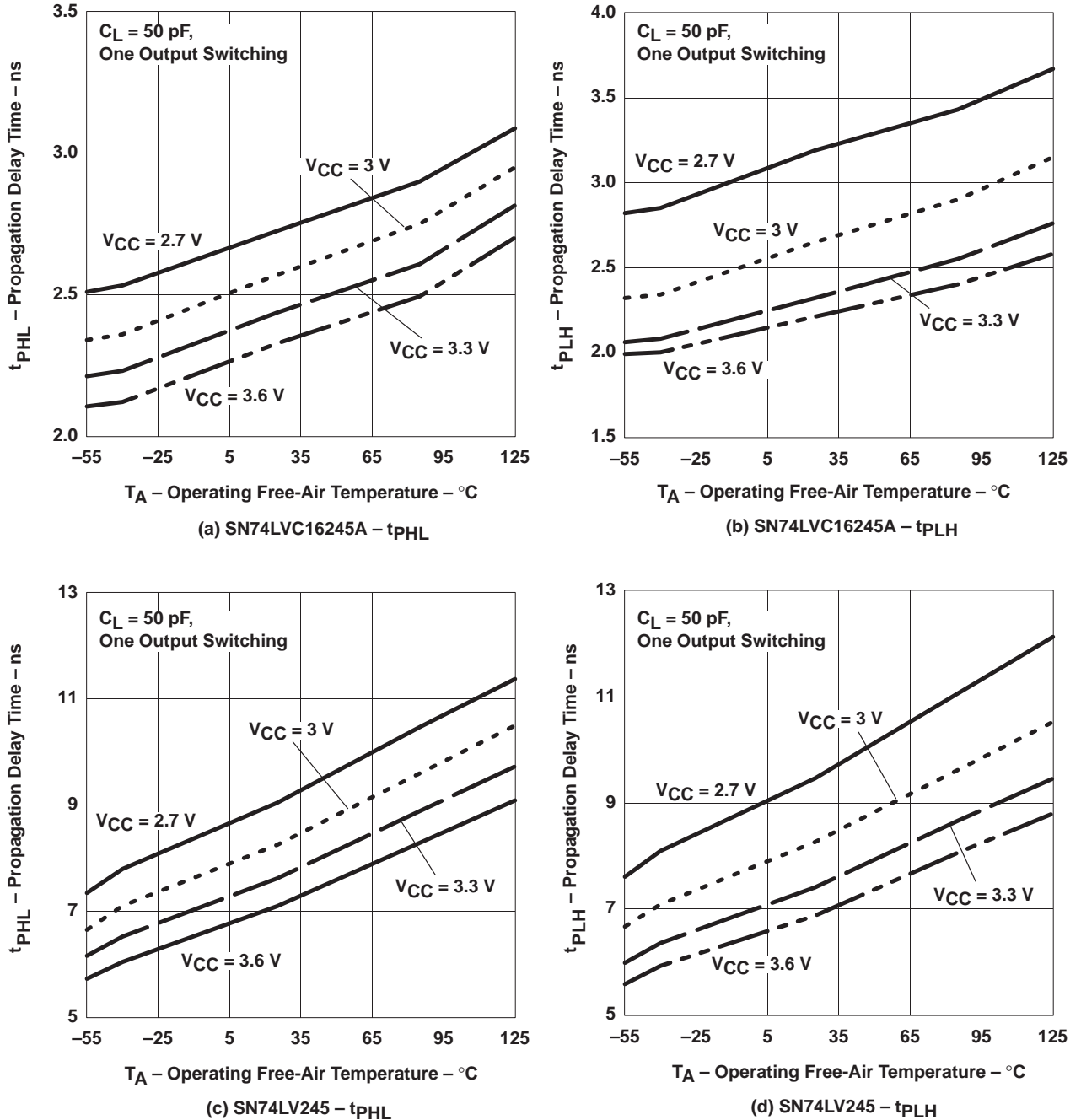
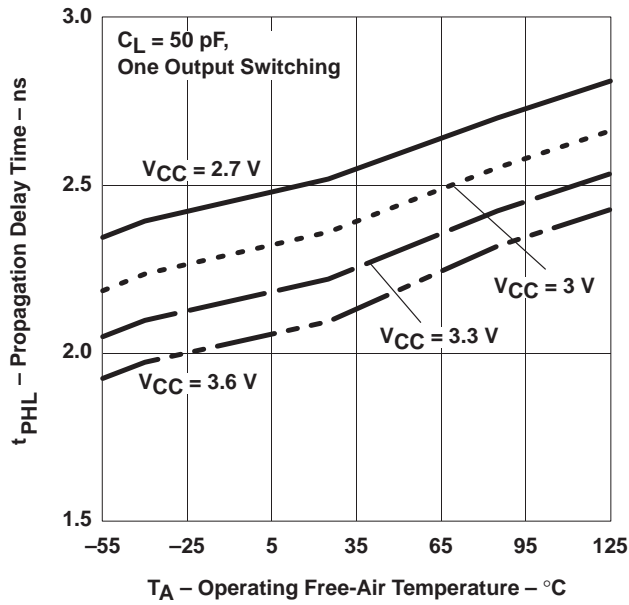
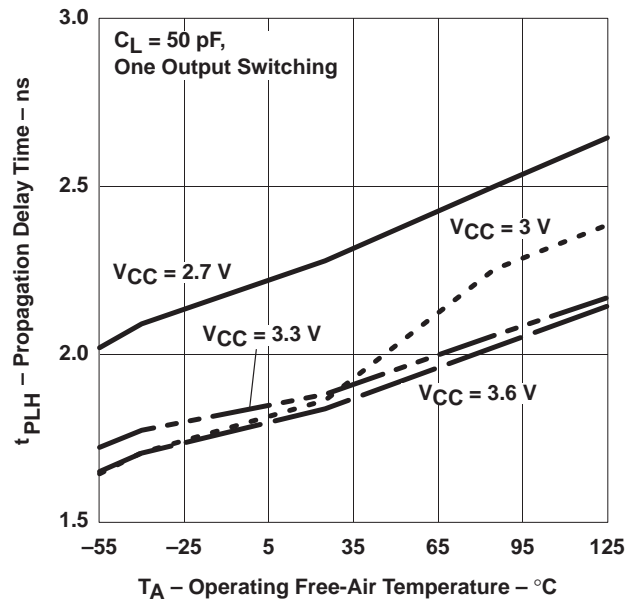

Figure 3. Propagation Delay Time Versus Operating Free-Air Temperature



(a) SN74ALVCH16245 -  $t_{PHL}$



(b) SN74ALVCH16245 -  $t_{PLH}$

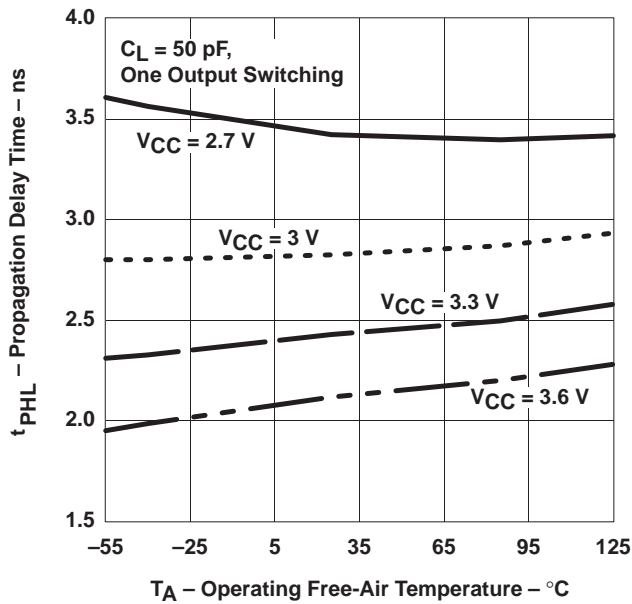

(c) SN74LVT16245 -  $t_{PHL}$

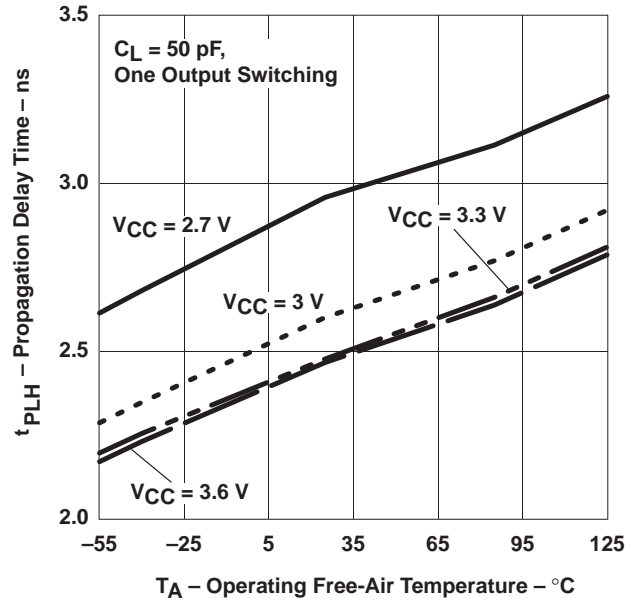

(d) SN74LVT16245 -  $t_{PLH}$

Figure 3. Propagation Delay Time Versus Operating Free-Air Temperature (Continued)

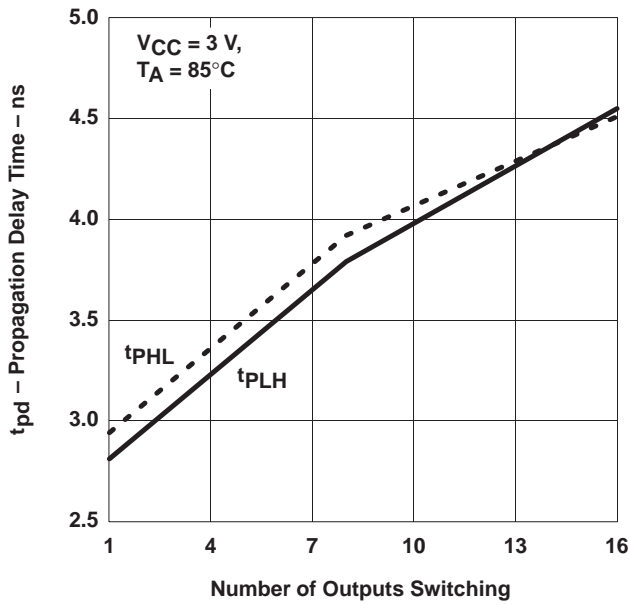

(a) SN74LVC16245A

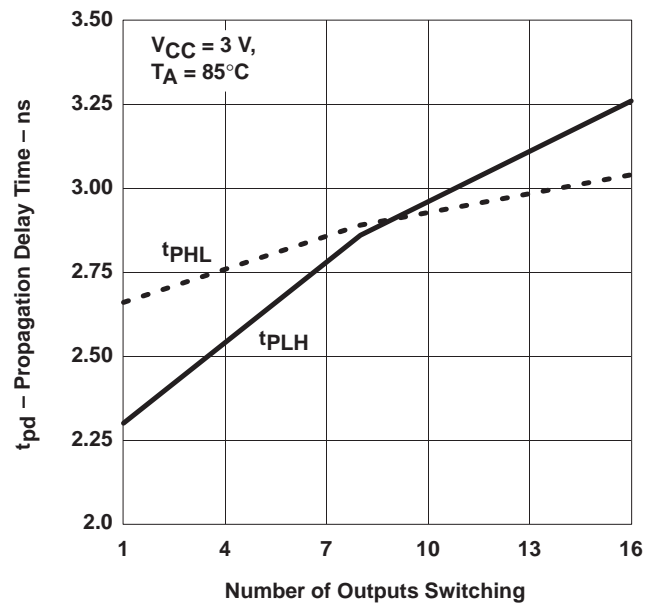

(b) SN74ALVCH16245

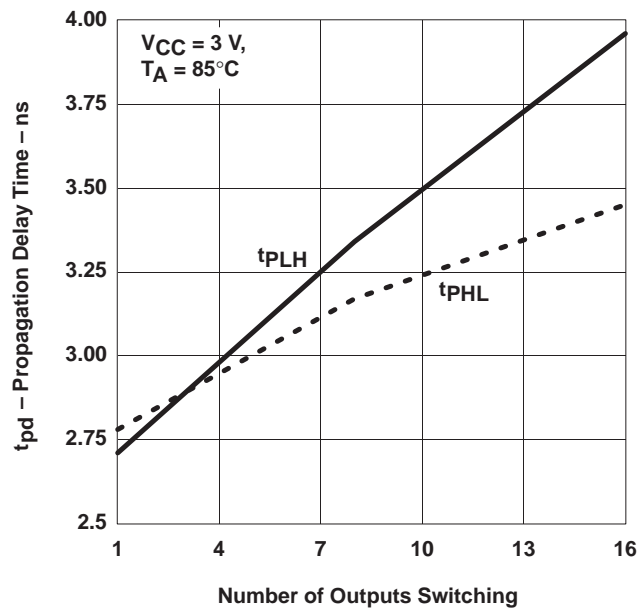

(c) SN74LVT16245

Figure 4. Propagation Delay Time Versus Number of Outputs Switching

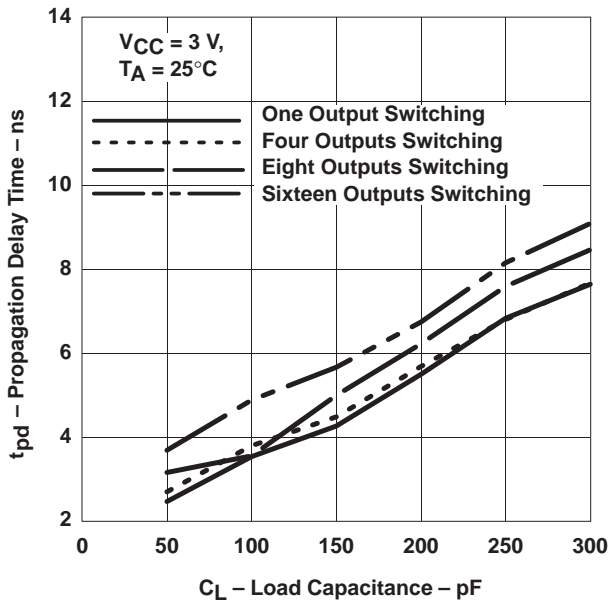

(a) SN74LVC16245A - t(PLH)

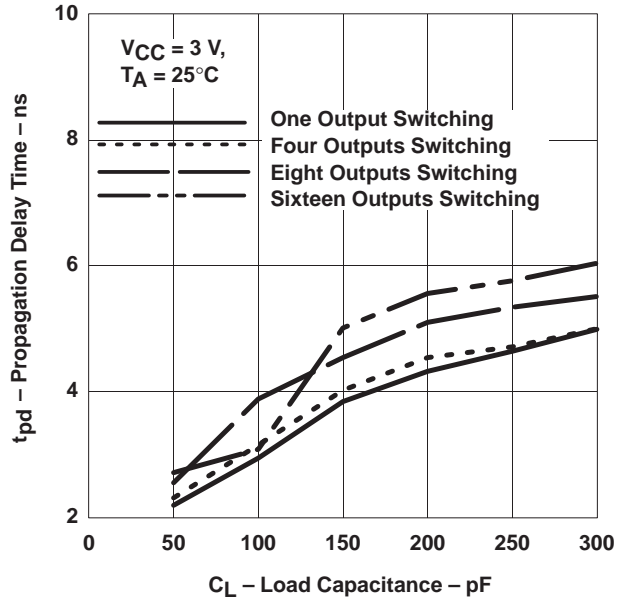

(b) SN74LVC16245A - t(PHL)

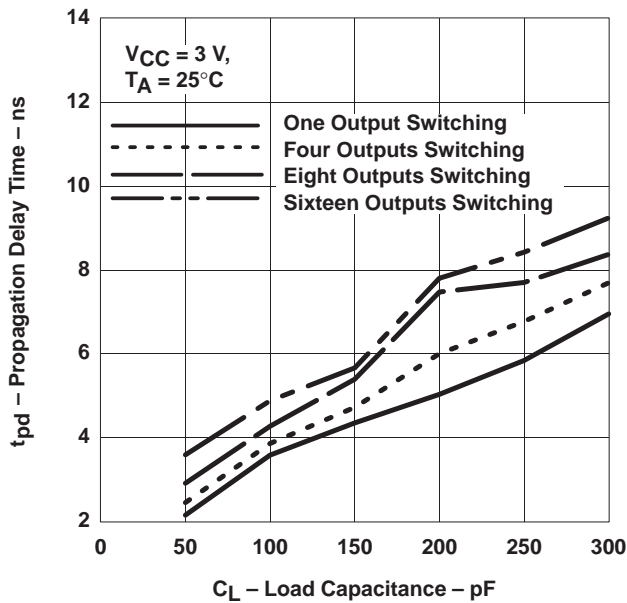

(c) SN74ALVCH16245 - t(PLH)

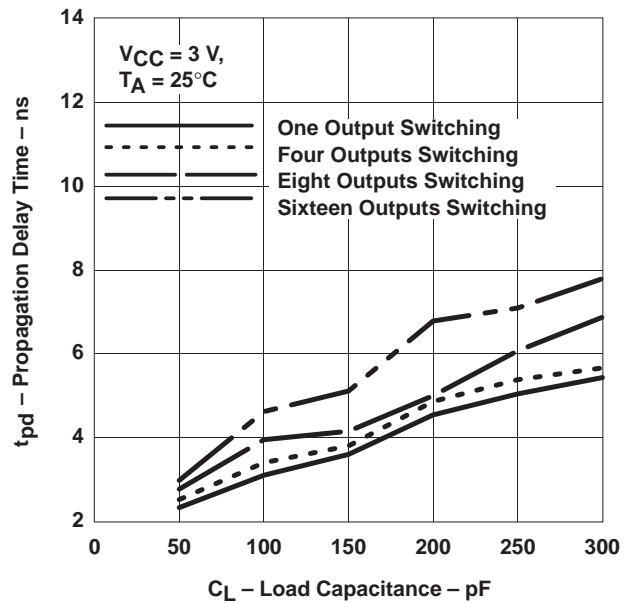

(d) SN74ALVCH16245 - t(PHL)

Figure 5. Propagation Delay Time Versus Load Capacitance

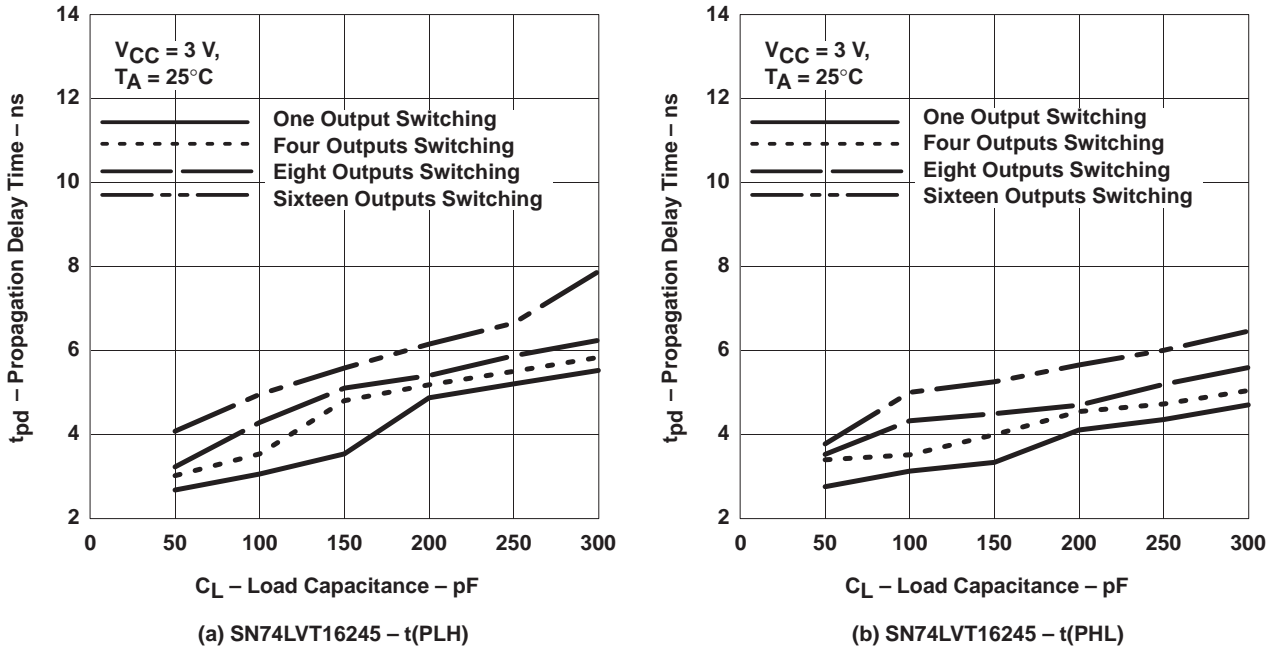

Figure 5. Propagation Delay Time Versus Load Capacitance (Continued)

### Power Considerations

The continued general industry trend is to make devices more robust and faster while reducing their size and power consumption. The LVC family of devices uses a CMOS output structure that has low power consumption and provides a medium drive current capability.

When calculating the amount of power consumed, both static (dc) and dynamic (ac) power must be considered. A variable when computing static power is  $I_{CC}$  and is provided in the data sheet for each specific device. The LVC family  $I_{CC}$  typically offers one-half of the LV family  $I_{CC}$ , one-fourth of the ALVC family  $I_{CC}$ , and a small fraction of the LVT family  $I_{CC}$ .

The majority of power consumed is dynamic due to the charging and discharging of internal capacitance and external load capacitance. The internal parasitic capacitances are known as  $C_{pd}$  and are expressed by Equation 2.

$$C_{pd} = [(I_{CC}(\text{dynamic}) \div (V_{CC} \times f)) - C_L] \quad (2)$$

Where:

- $I_{CC}$  = Measured value of current into the device (A)
- $V_{CC}$  = Supply voltage (V)
- $f$  = Frequency (Hz)
- $C_L$  = External load capacitance (F)

When comparing the dynamic power consumed between LV, LVC, ALVC and LVT, Figure 6 shows that pure CMOS devices (the LV, LVC, and ALVC families) consume approximately the same power as BiCMOS devices (the LVT family) around the frequency of 10 MHz, but consume significantly less power as the frequency approaches 100 MHz.

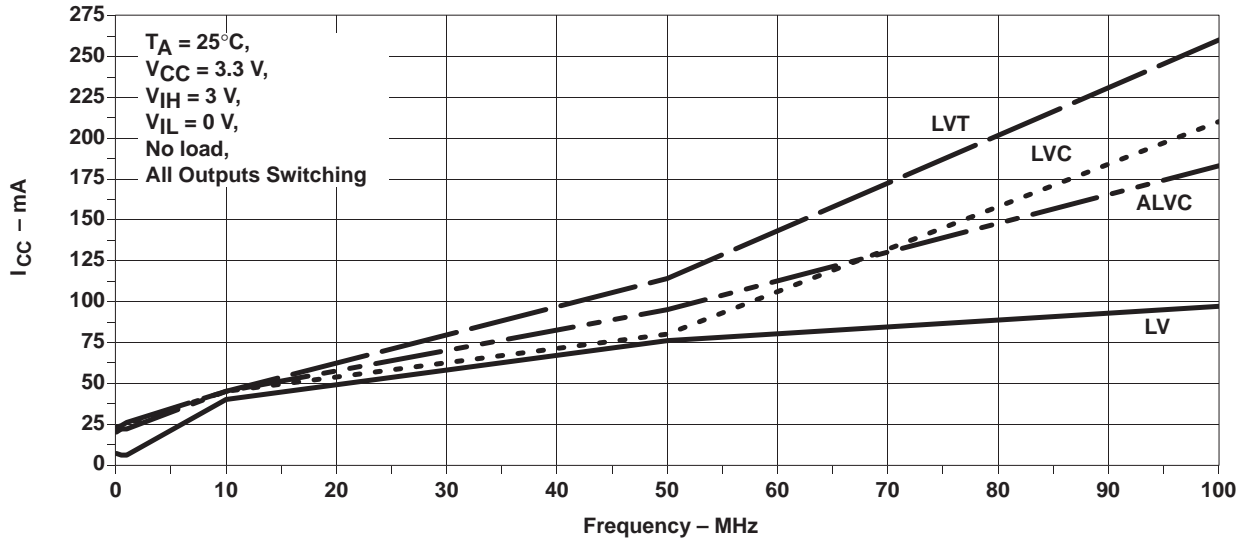

Figure 6.  $I_{CC}$  Versus Frequency

For an LVC device, the overall power consumed can be expressed by the following equation:

$$P_T = P_{\text{(static)}} + P_{\text{(dynamic)}} \quad (3)$$

Where:

for inputs with rail-to-rail signal swing:

$$P_S = V_{CC} \times I_{CC} \quad (4)$$

$$P_D = [(C_{pd} + C_L) \times V_{CC}^2 \times f] \times N_{SW}$$

and for TTL-level inputs:

$$P_S = V_{CC}[I_{CC} + (N_{TTL} \times \Delta I_{CC} \times DC_d)] \quad (5)$$

$$P_D = [(C_{pd} + C_L) \times V_{CC}^2 \times f] \times N_{SW}$$

Where:

$V_{CC}$  = Supply voltage (V)

$I_{CC}$  = Power supply current (A)

$C_{pd}$  = Power dissipation capacitance (F)

$C_L$  = External load capacitance (F)

$f$  = Operating frequency (Hz)

$N_{SW}$  = Total number of outputs switching

$N_{TTL}$  = Total number of outputs (where corresponding input is at the TTL level)

$\Delta I_{CC}$  = Power supply current (A) when inputs are at a TTL level

$DC_d$  = % duty cycle of the data (50% = 0.5)

## Input Characteristics

The LVC family input structure is such that the 3.3-V CMOS dc  $V_{IL}$  and  $V_{IH}$  fixed levels of 0.8 V and 2 V are ensured, meaning that while the threshold voltage of 1.5 V is typically where the transition from a recognized low input to a recognized high input occurs (see Figure 7), it is at the levels of 0.8 V and 2 V where the corresponding output state is ensured. Additionally, a reduction in overall bus loading exists in the LVC family due to the relatively high impedance and low capacitance characteristics of CMOS input circuitry.

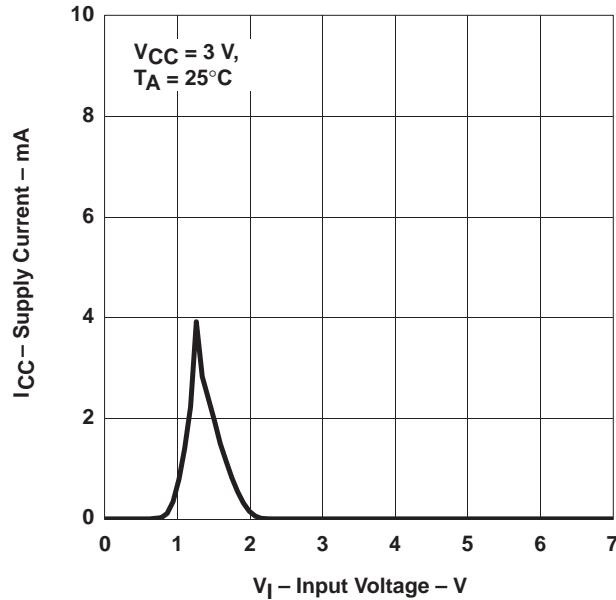

Figure 7. Supply Current Versus Input Voltage

### LVC Input Circuitry

The simplified LVC input circuit shown in Figure 8 consists of two transistors, sized to achieve a threshold voltage of 1.5 V (see Figure 9). Since  $V_{CC}$  is 3.3 V and the threshold voltage is commonly set to be centered around one-half of  $V_{CC}$  in a pure CMOS input (see Figure 1), additional circuitry to reduce the voltage level is not required and the resulting simplified input structure consists of two transistors. When the input voltage  $V_I$  is low, the PMOS transistor ( $Q_p$ ) turns on and the NMOS transistor ( $Q_n$ ) turns off, causing current to flow through  $Q_p$ , resulting in the output voltage (of the input stage) to be pulled high. Conversely, when  $V_I$  is high,  $Q_n$  turns on and  $Q_p$  turns off, causing current to flow through  $Q_n$ , resulting in the output voltage (on the input stage) to be pulled low.

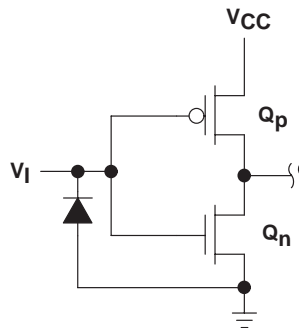
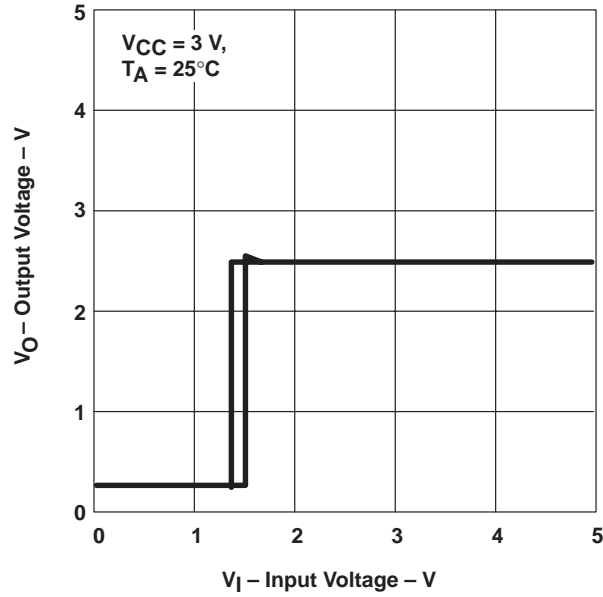

Figure 8. Simplified Input Stage of an LVC Circuit

Figure 9 is a graph of  $V_O$  versus  $V_I$ . An input hysteresis of approximately 100 mV is inherent to the LVC process geometry, which ensures the devices are free from oscillations by increasing the noise margin around the threshold voltage.



**Figure 9. Output Voltage Versus Input Voltage**

Figure 10 is a graph of  $I_I$  versus  $V_I$ . The inputs of all LVC devices are 5-V tolerant and have a recommended operating condition range from 0 V to 5.5 V. If the input voltage is within this range, the functionality of the device is ensured.

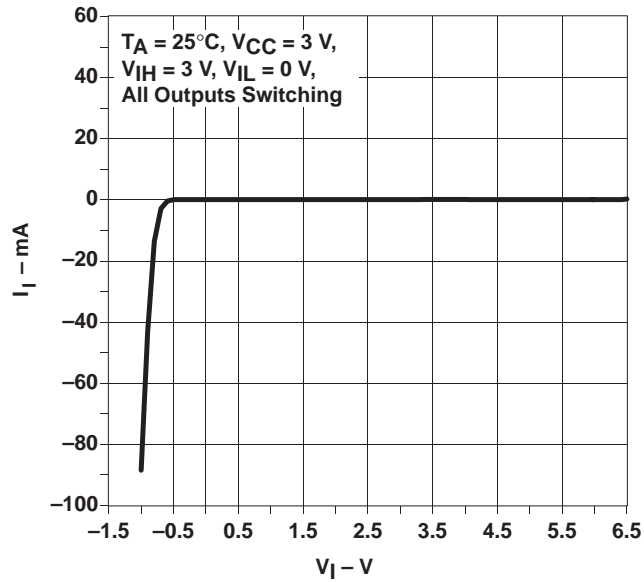

**Figure 10. Input Current Versus Input Voltage**



## Input Current Loading

Minimal loading of the system bus occurs when using the LVC family due to the EPIC™ submicron process CMOS input structure; the only loading that occurs is caused by leakage current and capacitance. Input current is low, typically less than 100 pA, as shown in Figure 11 and Table 1. Capacitance for transceivers can be as low as 3.3 pF for  $C_i$  and 5.4 pF for  $C_{i0}$ . Since both of the variables that can affect bus loading are relatively insignificant, the overall impact on bus loading on the input side using LVC devices is minimal and, depending upon the logic family being used, bus loading can decrease as a result of using LVC parts.

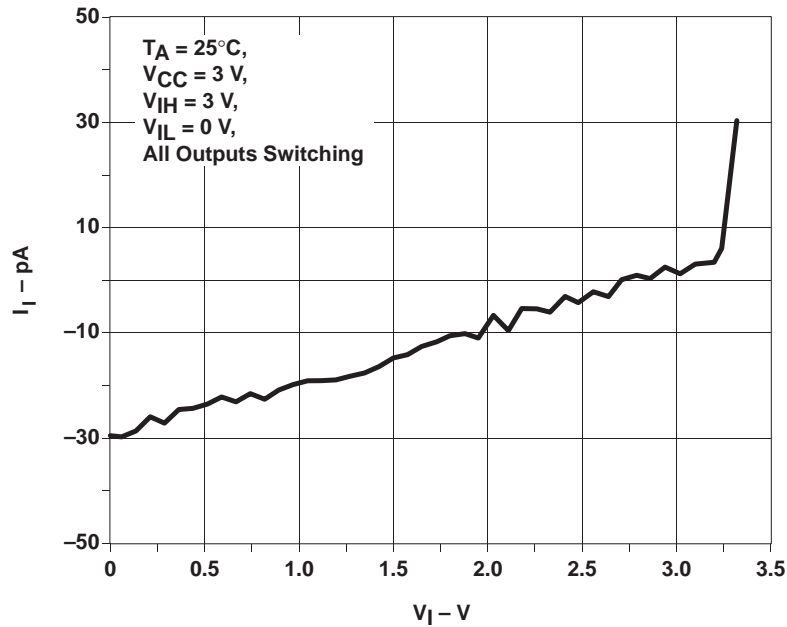

Figure 11. Input Leakage Current Versus Input Voltage

Table 1. Input Current Specifications

PARAMETER	TEST CONDITIONS		SN74LVC245A	
			MIN	MAX
$I_I$	$V_I = 5.5\text{ V or GND,}$	$V_{CC} = 3.6\text{ V}$	$\pm 5\ \mu\text{A}$	
$I_{OZ}^\dagger$	$V_O = V_{CC}\text{ or GND,}$	$V_{CC} = \text{MIN to MAX}$	$\pm 10\ \mu\text{A}$	
$I_{OZ}^\dagger$	$V_O = 3.6\text{ V or 5.5 V,}$	$V_{CC} = \text{MIN to MAX}$	$\pm 50\ \mu\text{A}$	

<sup>†</sup> For I/O ports, the parameter  $I_{OZ}$  includes the input leakage current.

## Supply Current Change ( $\Delta I_{CC}$ )

LVC devices operate using the switching standard levels shown in Figure 1. However, because the input circuitry is CMOS, an additional specification,  $\Delta I_{CC}$ , is provided to indicate the amount of input current present when both p- and n-channel transistors are conducting. Although this situation exists whenever a low-to-high (or high-to-low) transition occurs, the transition usually occurs so quickly that the current flowing while both transistors are conducting is negligible. It is more of a concern, however, when a device with a TTL output drives the LVC part. Here, a dc voltage that is not at the rail, is applied to the input of the LVC device. The result is that both the n-channel transistor and the p-channel transistor are conducting and a path from  $V_{CC}$  to GND is established. This current is specified as  $\Delta I_{CC}$  in the data sheet for each device and is measured one input at a time with the input voltage set at  $V_{CC} - 0.6$  V, while all other inputs are at  $V_{CC}$  or GND. Table 2 provides the  $\Delta I_{CC}$  specification, which is contained in the data sheet for any LVC part.

**Table 2.  $\Delta I_{CC}$  Current Specifications**

PARAMETER	TEST CONDITIONS	SN74LVC245A	
		MIN	MAX
$\Delta I_{CC}$	One input at $V_{CC} - 0.6$ V, Other inputs at $V_{CC}$ or GND, $V_{CC} = 2.7$ V to 3.6 V		500 $\mu$ A

## Proper Termination of Unused Inputs and Bus Hold

A characteristic of all CMOS input structures is that any unused inputs should not be left floating; they should be tied high to  $V_{CC}$  or low to GND via a resistor. The value of the resistor should be approximately 1k $\Omega$ . If the inputs are not tied high or low but are left floating, excessive output glitching or oscillations can result due to induced voltage transients on the parasitic lead inductance inherent to the device input and output structure.

Implementation of the bus-hold feature on select devices is a recent enhancement to the LVC logic family. Bus hold eliminates the need for floating inputs to be tied high or low by holding the last known state of the input until the next input signal is present. Bus hold is a circuit composed of two back-to-back inverters with the output fed to the input via a resistor. Figure 12 is a simplified illustration of the bus-hold circuit. Figure 13 shows  $I_{I(\text{hold})}$  as  $V_I$  is swept from 0 to 4 V. Bus hold is beneficial because of the decreased expense of purchasing additional resistors, reduced overall power consumption, and because it frees up limited board space.

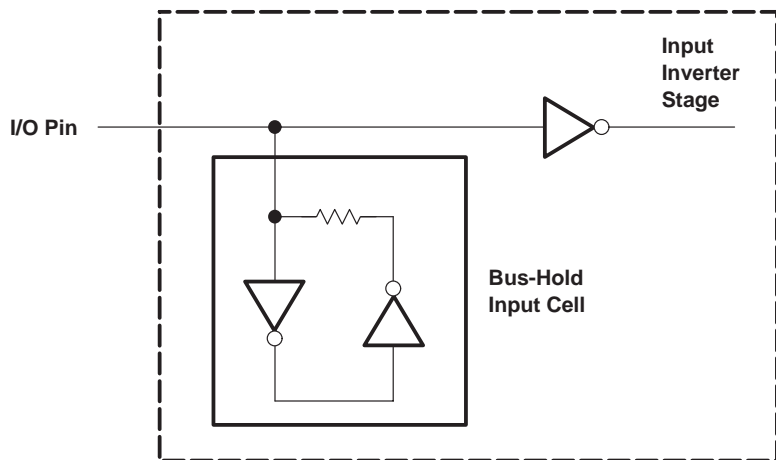

**Figure 12. Bus Hold**

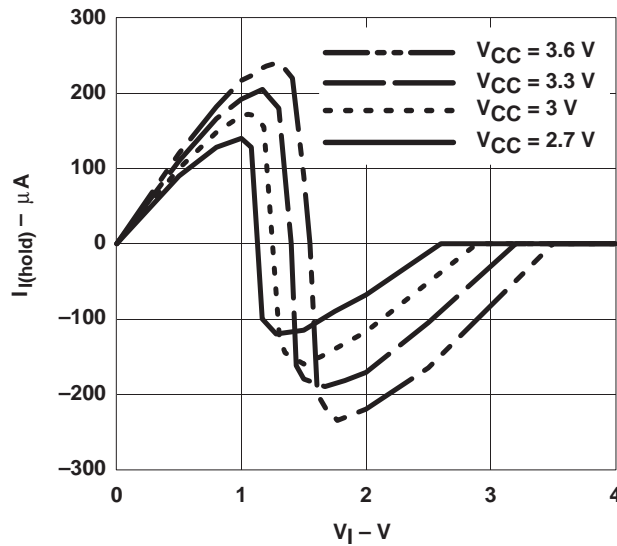

Figure 13.  $I_{I(\text{hold})}$  Versus  $V_I$

Not all LVC devices have the bus-hold feature. Those that do are identified by the letter H added to the device name; e.g., SN74LVCH245. Additionally, any device with bus hold has an  $I_{I(\text{hold})}$  specification in the data sheet. Finally, bus hold does not contribute significantly to input current loading or output driving loading because it has a minimum hold current of  $75 \mu\text{A}$  and a maximum hold current of  $500 \mu\text{A}$  as shown in Table 3.

Table 3. Bus-Hold Specifications [ $I_{I(\text{hold})}$ ]

PARAMETER	TEST CONDITIONS	SN74LVC245	
		MIN	MAX
$\Delta I_{I(\text{hold})}$	$V_I = 0.8 \text{ V}$ , $V_{CC} = 3 \text{ V}$	$75 \mu\text{A}$	
	$V_I = 2 \text{ V}$ , $V_{CC} = 3 \text{ V}$	$-75 \mu\text{A}$	
	$V_I = 0 \text{ to } 3.6 \text{ V}$ , $V_{CC} = 3.6 \text{ V}$		$\pm 500 \mu\text{A}$

### Output Characteristics

The LVC family uses a pure CMOS output structure. This is true of all low-voltage families except the LVT family, which uses both bipolar and CMOS circuitry. The LVC family has the dc characteristics shown in Table 4.

Table 4. LVC Output Specifications

PARAMETER	TEST CONDITIONS	SN74LVC244A		
		MIN	TYP	MAX
$V_{OH}$	$I_{OH} = -100 \mu\text{A}$ , $V_{CC} = \text{MIN to MAX}$	$V_{CC} - 0.2 \text{ V}$		
	$I_{OH} = -12 \text{ mA}$ , $V_{CC} = 2.7 \text{ V}$	$2.2 \text{ V}$		
	$I_{OH} = -12 \text{ mA}$ , $V_{CC} = 3 \text{ V}$	$2.4 \text{ V}$		
	$I_{OH} = -24 \text{ mA}$ , $V_{CC} = 3 \text{ V}$	$2.2 \text{ V}$		
$V_{OL}$	$I_{OL} = 100 \mu\text{A}$ , $V_{CC} = \text{MIN to MAX}$			$0.2 \text{ V}$
	$I_{OL} = 12 \text{ mA}$ , $V_{CC} = 2.7 \text{ V}$			$0.4 \text{ V}$
	$I_{OL} = 24 \text{ mA}$ , $V_{CC} = 3 \text{ V}$			$0.55 \text{ V}$
$I_{OZ}^\dagger$	$V_O = V_{CC} \text{ or GND}$ , $V_{CC} = \text{MIN to MAX}$			$\pm 10 \mu\text{A}$
$I_{OZ}^\dagger$	$V_O = 3.6 \text{ V to } 5.5 \text{ V}$ , $V_{CC} = \text{MIN to MAX}$			$\pm 50 \mu\text{A}$
$C_o$	$V_O = V_{CC} \text{ or GND}$ , $V_{CC} = 3.3 \text{ V}$			$5 \text{ pF}$

<sup>†</sup> For I/O ports, the parameter  $I_{OZ}$  includes the input leakage current.

## LVC Output Circuitry

Figure 14 shows a simplified output stage of an LVC circuit. When the NMOS transistor ( $Q_n$ ) turns off and the PMOS transistor ( $Q_p$ ) turns on and begins to conduct, the output voltage ( $V_O$ ) is pulled high. Conversely, when  $Q_p$  turns off,  $Q_n$  begins to conduct and  $V_O$  is pulled low.

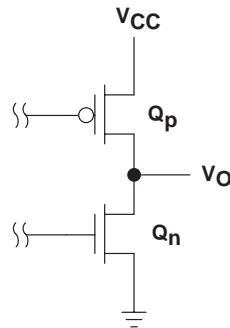

Figure 14. Simplified Output Stage of an LVC Circuit

## Output Drive

Figure 15 illustrates values of  $I_{OL}$  and  $I_{OH}$  and the corresponding values of  $V_{OL}$  and  $V_{OH}$  for a typical LVC device.

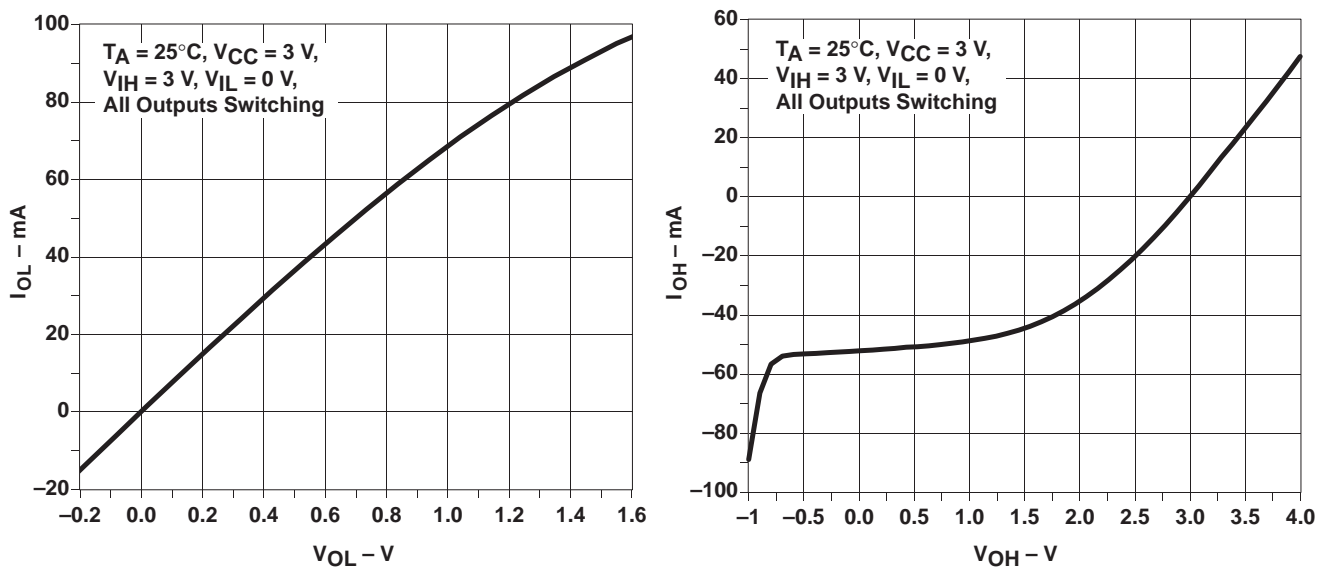

Figure 15. Typical LVC Output Characteristics

## Partial Power Down

To partially power down a device, no paths from  $V_I$  to  $V_{CC}$  or from  $V_O$  to  $V_{CC}$  can exist. With the LVC family, a path from  $V_I$  to  $V_{CC}$  has never been an issue. However, early LVC devices that were not 5-V tolerant do have a path from  $V_O$  to  $V_{CC}$ . For these devices, when  $V_{CC}$  begins to diminish, a diode from  $V_O$  to  $V_{CC}$  begins to conduct and current flows, resulting in damage to the power supply and or to the device. Today, the 5-V tolerant LVC devices are designed in such a way that this path from  $V_O$  to  $V_{CC}$  is eliminated. As such, 5-V tolerant devices are capable of being partially powered down.

## Proper Termination of Outputs

Depending on the trace length, special consideration may need to be given to the termination of the outputs. As a general rule, if the trace length is less than four inches, no additional components are necessary to achieve proper termination. If the trace length is greater than four inches, reflections begin to appear on the line and the system may appear noisy and generate unreliable data. The solution to this is to terminate the outputs in an appropriate manner to minimize the reflections.

Figure 16 illustrates five different techniques for terminating the outputs. The ideal situation is to identically match the impedance ( $Z_0$ ) of the trace and eliminate all reflections. In practice, however, exactly matching  $Z_0$  is not always possible and settling for a close enough match that adequately minimizes the reflections may be the only option.

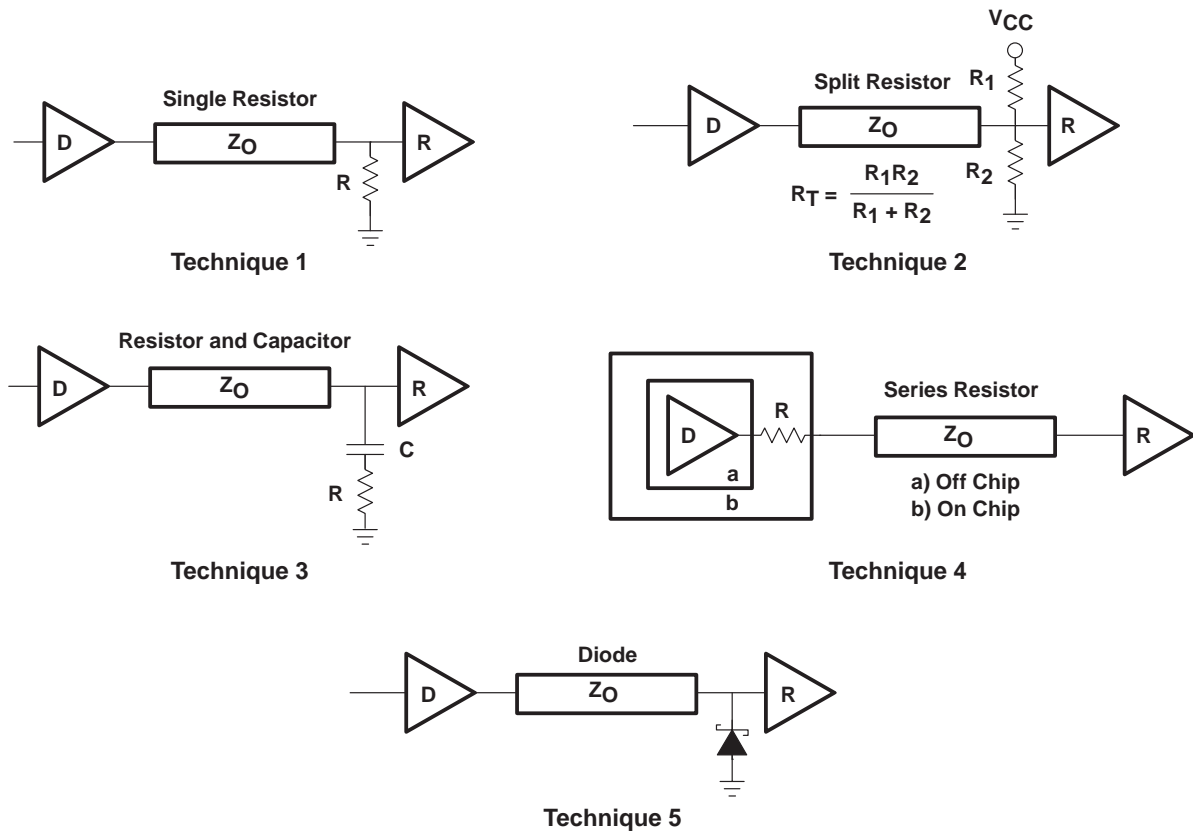

Figure 16. Termination Techniques

### Technique 1

Technique 1 consists of a single resistor tied to GND. The ideal value of the resistor is  $R = Z_0$ , and the best placement for it is as close to the receiver as possible. A heavy increase in power occurs, but no further delay is present. There is a relatively low dc noise margin in this configuration.

### Technique 2

Technique 2 involves two split resistors; one resistor ( $R_1$ ) is tied to  $V_{CC}$  and the other ( $R_2$ ) is tied to GND. The ideal value of the resistors is  $R_1 = R_2 = 2Z_0$ ;  $R_T = (R_1 \times R_2)/(R_1 + R_2)$ , and the best placement for the resistors is as close to the receiver as possible. Technique 2 results in a heavy increase in power, with no delay being experienced, and is primarily used in backplane designs where proper drive currents must be maintained.

### Technique 3

Technique 3 has a capacitor in series with a resistor, both of which are running parallel to GND. The ideal value of the resistor is  $R = Z_0$ , and the value of the capacitor should be  $60\text{pF} < C < 330\text{pF}$ . To determine the ideal value of the capacitor, it is recommended that a model simulation tool be used. The ideal placement of the resistor and capacitor is as close to the receiver as possible. Technique 3 has the highest amount of power consumed as the frequency increases, but no additional delay is experienced. Note that this termination technique can be optimized for only one given signal frequency.

#### Technique 4

Technique 4 consists of a resistor in series with the output of the driving device and can be divided into two alternatives, depending on whether the resistor is physically located on or off the driving device. If the resistor is not located on the device, the value of the resistor should be  $R = Z_O - Z_D$ , where  $Z_D$  is the output impedance of the driver, and the best placement is as close to the driver as possible. Although a delay occurs, no power increase is experienced and this technique has a relatively good noise margin. If the resistor is integrated on the device and part of the chip, its value is usually  $25 < R < 33 \Omega$ . This setup has a slight delay, has no increase in power, has good undershoot clamping, and is useful for point-to-point driving.

#### Technique 5

Technique 5 consists of a diode to GND that should be located as close as possible to the receiver. An increase in power is not experienced, no delay occurs, and this configuration is useful for standard backplane terminations.

Technique 5 is the most attractive of all techniques since there is no power increase and no delay occurs. However, since the delay associated with Technique 4 is so minimal and since no additional devices are required, whereas in all the other techniques at least one additional component is required, Technique 4 is usually the technique recommended by the Advanced System Logic department of Texas Instruments.

These five techniques, together with their advantages and disadvantages, are summarized in Table 5.

**Table 5. Termination Techniques Summary**

TECHNIQUE	ADDITIONAL DEVICES	POWER INCREASE	SETS STATIC LINE LEVEL	DELAY	IDEAL VALUE	COMMENTS
Single resistor	1	Significant	Yes	No	$R = Z_O$	Low dc noise margin
Split resistor	2	Significant	Yes	No	$R_1 = R_2 = 2Z_O$	Good for backplanes due to maintaining drive current
Resistor and capacitor	2	Yes	No	No	$R = Z_O$ $60 < C < 330 \text{ pF}$	Increase in frequency and power
Series resistor, off device	1	No	No	Yes	$R = Z_O - Z_D$	Good noise margin
Series resistor, on device	0	No	No	Small	$25 < R < 33 \Omega$	Good undershoot clamping; useful for point-to-point driving
Diode	1	No	No	No	NA	Good undershoot clamping; useful for standard backplane terminations

## Signal Integrity

System designers often are concerned with the performance of a device when the outputs are switched. The most common method of assessing this is by observing the impact on a single output when multiple outputs are switched.

The phenomenon of simultaneous switching can be measured with respect to GND or with respect to  $V_{CC}$ . When measuring with respect to GND, the voltage output low peak ( $V_{OLP}$ ) is the impact on one quiet, logic-low output when all the other outputs are switched from high to low. The converse is true when measuring simultaneous switching with respect to  $V_{CC}$ ; i.e., the voltage output high valley ( $V_{OHV}$ ) is the impact on one quiet, logic-high output when all the other outputs are switched from low to high. Figure 17 shows an example of simultaneous switching with respect to  $V_{OLP}$  and  $V_{OHV}$ .

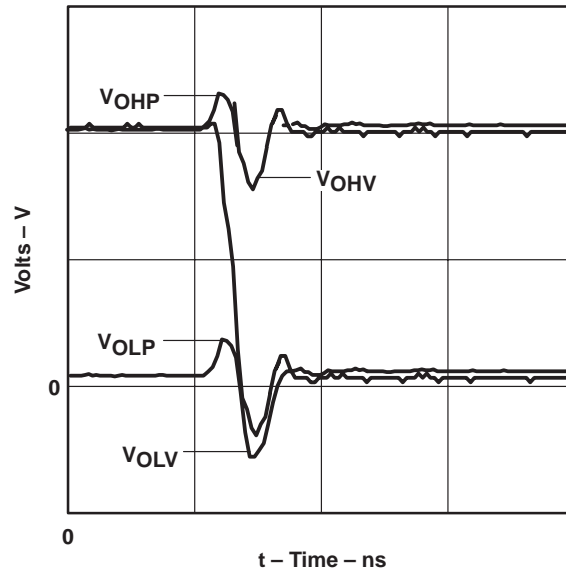

**Figure 17. Simultaneous Switching Noise Waveform**

One technique to reduce the impact of simultaneous switching on a device is to increase the number of power and GND pins. The strategy is to disperse them throughout the chip to reduce mutual inductances between signals (see *Advanced Packaging*). For a complete discussion of simultaneous switching, refer to TI's *Simultaneous Switching Evaluation and Testing* application report or the *Advanced CMOS Logic Designer's Handbook*, literature number SCAA001A.

## Acknowledgment

This application report was written by Steven Culp, ABL applications engineering.