

NS 10165T 220MNA

https://www.yuden.co.jp/productdata/catalog/en/wound08_e.pdf

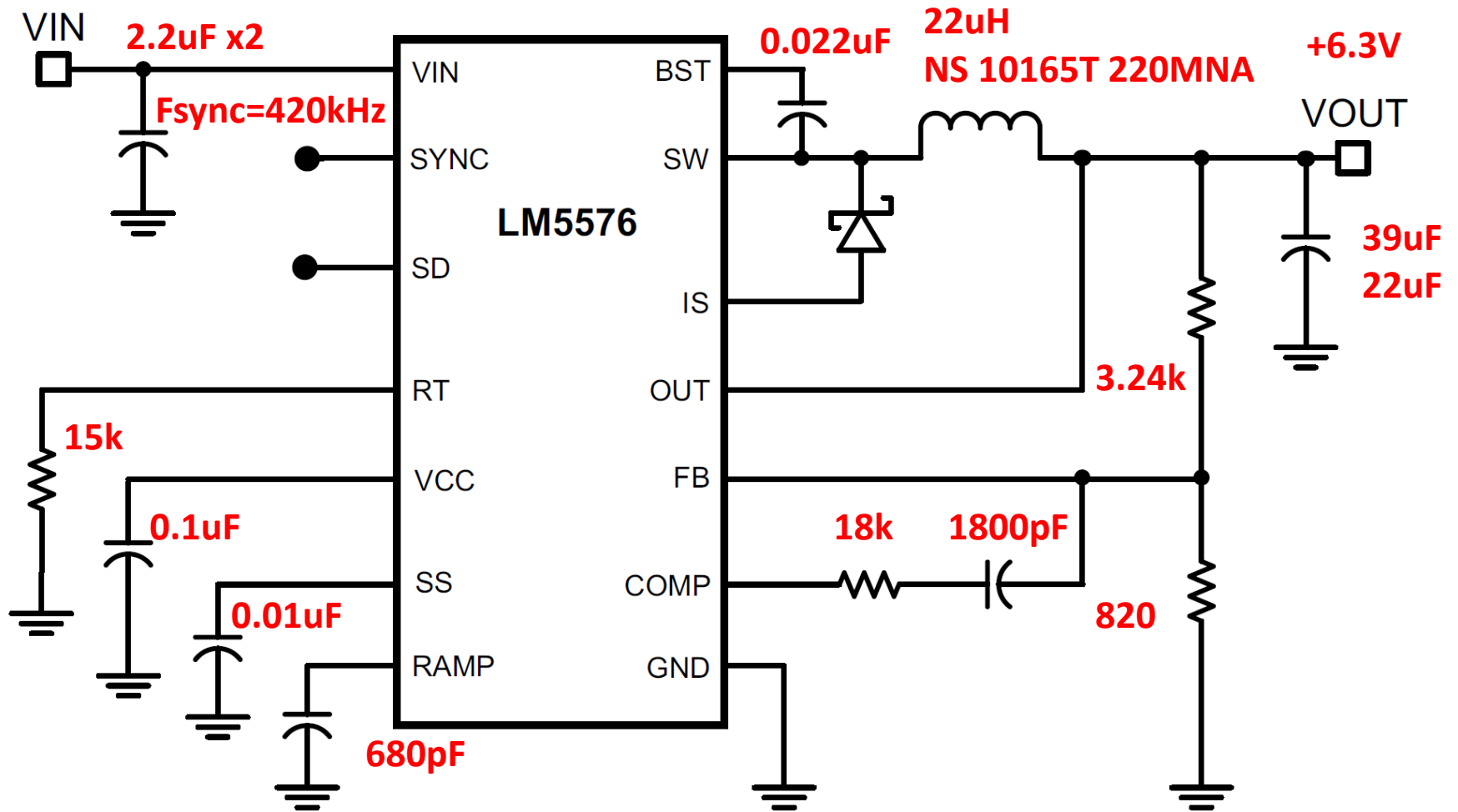

$I_{out}=100mA$

$I_{out}=1000mA$

$I_{out}=1700mA$

$V_{in}=22V$

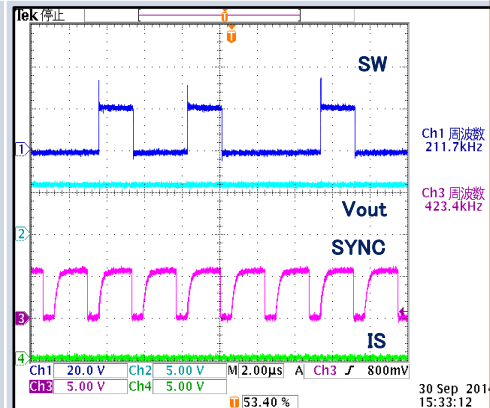
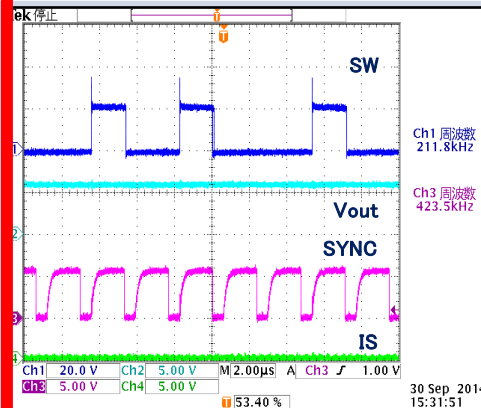
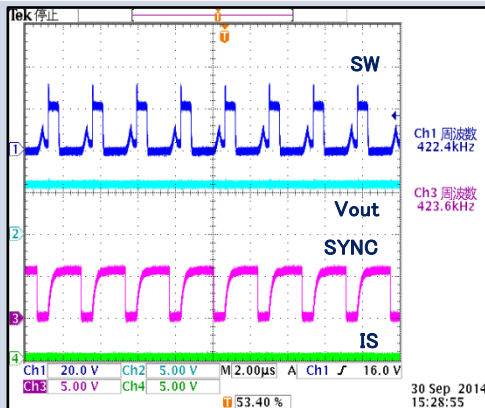

$V_{in}=40V$

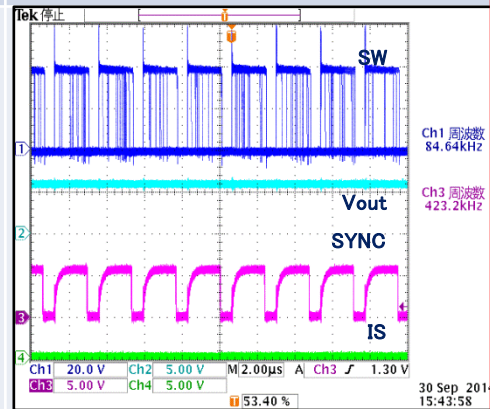
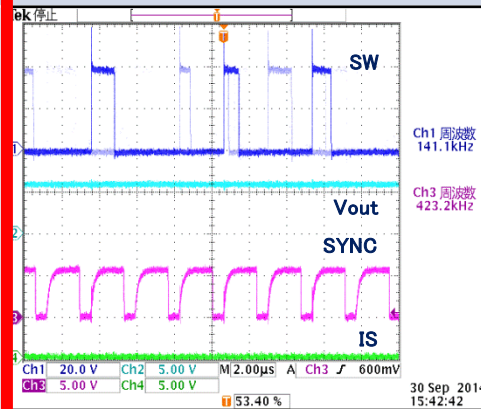
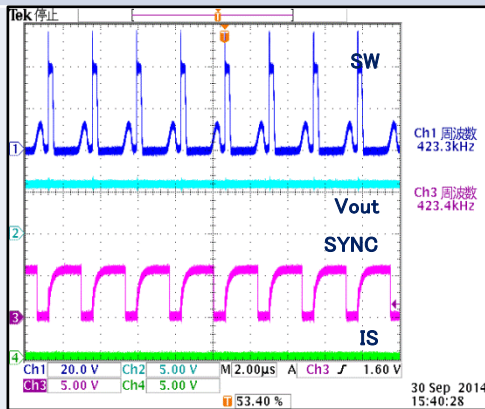

$V_{in}=50V$

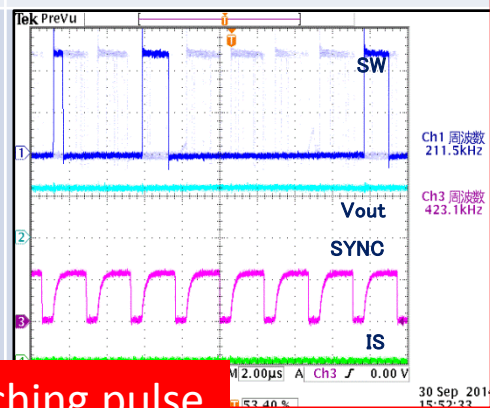
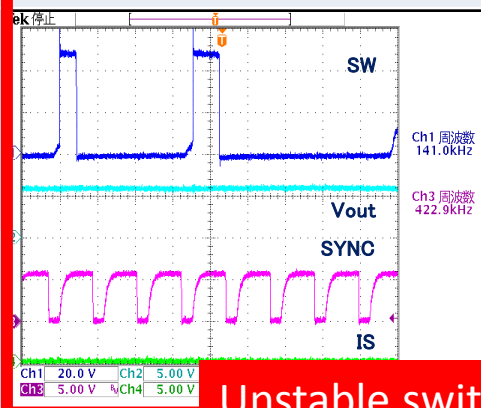
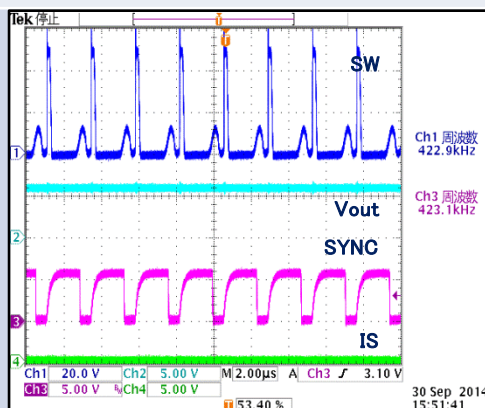

Unstable switching pulse